

SmartLogger3000

User Manual

Issue 16
Date 2023-11-07



Copyright © Huawei Technologies Co., Ltd. 2023. All rights reserved.

No part of this document may be reproduced or transmitted in any form or by any means without prior written consent of Huawei Technologies Co., Ltd.

Trademarks and Permissions



HUAWEI and other Huawei trademarks are trademarks of Huawei Technologies Co., Ltd.

All other trademarks and trade names mentioned in this document are the property of their respective holders.

Notice

The purchased products, services and features are stipulated by the contract made between Huawei and the customer. All or part of the products, services and features described in this document may not be within the purchase scope or the usage scope. Unless otherwise specified in the contract, all statements, information, and recommendations in this document are provided "AS IS" without warranties, guarantees or representations of any kind, either express or implied.

The information in this document is subject to change without notice. Every effort has been made in the preparation of this document to ensure accuracy of the contents, but all statements, information, and recommendations in this document do not constitute a warranty of any kind, express or implied.

Huawei Technologies Co., Ltd.

Address: Huawei Industrial Base
Bantian, Longgang
Shenzhen 518129
People's Republic of China

Website: <https://e.huawei.com>

About This Document

Purpose





This document introduces the SmartLogger3000 (SmartLogger for short) and SmartModule1000 (SmartModule for short) in terms of installation, electrical connections, system operation and maintenance, and troubleshooting. Understand the SmartLogger and SmartModule features, functions, and safety precautions provided in this document before installing and operating the SmartLogger and SmartModule.

Intended Audience

This document is intended for operating personnel and qualified electricians of photovoltaic (PV) and energy storage plants.

Symbol Conventions

The symbols that may be found in this document are defined as follows:

Symbol	Description
 DANGER	Indicates a hazard with a high level of risk which, if not avoided, will result in death or serious injury.
 WARNING	Indicates a hazard with a medium level of risk which, if not avoided, could result in death or serious injury.
 CAUTION	Indicates a hazard with a low level of risk which, if not avoided, could result in minor or moderate injury.
 NOTICE	Indicates a potentially hazardous situation which, if not avoided, could result in equipment damage, data loss, performance deterioration, or unanticipated results. NOTICE is used to address practices not related to personal injury.

Symbol	Description
 NOTE	Supplements the important information in the main text. NOTE is used to address information not related to personal injury, equipment damage, and environment deterioration.

Change History

Updates between document issues are cumulative. The latest document issue contains all changes made in previous issues.

Issue 16 (2023-11-07)

- Updated [4.1.11 Installing a SIM Card and a 4G Antenna](#).
- Updated [6.2.1 Preparations and WebUI Login](#).
- Updated [6.2.4 Commissioning Using Deployment Wizard \(V300R023C00\)](#).
- Updated [6.3.8.1 Setting Parameters for a Built-in MBUS Module](#).
- Updated [6.3.8.2.1 Setting SmartMBUS CCO01A Parameters](#).
- Updated [6.3.10 Setting PCS Parameters](#).
- Updated [6.3.11 Setting CMU Parameters](#).
- Added [6.3.25 Setting IMD Parameters](#).
- Updated [6.4 Setting Battery Control Parameters](#).
- Updated [6.6 Setting Feature Parameters](#).
- Updated [7.4.6 License Management](#).
- Updated [7.4.11 Force Start](#).
- Updated [A Product User Lists](#).
- Added [E Contact Information](#).
- Added [F Digital Power Customer Service](#).

Issue 15 (2023-10-11)

- Updated [6.3.17 Setting Meter Parameters](#).
- Updated [6.4 Setting Battery Control Parameters](#).
- Updated [6.7.7 Setting DRM Parameters](#).
- Added [7.4.12 Device Replacement](#).

Issue 14 (2023-08-18)

- Updated [2.1.2 Networking](#).
- Updated [6.2.4 Commissioning Using Deployment Wizard \(V300R023C00\)](#).
- Added [6.3.5 Setting SPPC Communications Parameters](#).
- Updated [6.3.16 Setting PID Module Parameters](#).
- Updated [6.3.16.2 Setting SmartPID2000 Parameters](#).
- Updated [6.4 Setting Battery Control Parameters](#).
- Updated [6.6 Setting Feature Parameters](#).
- Updated [6.7.6 Setting Parameters for Smart Reactive Power Compensation](#).
- Updated [6.7.7 Setting DRM Parameters](#).
- Updated [7.4.6 License Management](#).
- Updated [9.1 Technical Specifications of the SmartLogger](#).

Issue 13 (2023-06-12)

- Updated [2.1.3 Appearance](#).
- Updated [2.2.3 Appearance](#).
- Updated [6.2.1 Preparations and WebUI Login](#).
- Updated [6.3.3 Setting Parameters for Connecting to the Management System](#).
- Updated [6.3.8 Setting MBUS Parameters](#).
- Updated [6.7.2 Setting Active Power Control](#).

Issue 12 (2023-04-20)

- Updated [2.1.2 Networking](#).
- Updated [4.1.10 Connecting Fiber Jumpers](#).
- Updated [6.2.4 Commissioning Using Deployment Wizard \(V300R023C00\)](#).
- Updated [6.3.3 Setting Parameters for Connecting to the Management System](#).
- Updated [6.3.8 Setting MBUS Parameters](#).
- Updated [6.3.16 Setting PID Module Parameters](#).
- Deleted "Setting Capacity Limit".
- Updated [6.4 Setting Battery Control Parameters](#).
- Updated [6.5 Setting EMS Control Parameters](#).
- Added [6.6 Setting Feature Parameters](#).

Issue 11 (2023-01-20)

- Updated [1 Safety Information](#).

- Updated [6.3.12 Setting ESU Parameters](#).
- Updated [6.3.17 Setting Meter Parameters](#).
- Updated [6.4 Setting Battery Control Parameters](#).
- Updated [6.7.8.2 Setting NS Protection Remote Shutdown](#).
- Updated [7.4.11 Force Start](#).
- Updated [7.5 Device Replacement](#).
- Added [8.18 Resetting Password](#).
- Updated [8.13 Which Models of Power Meters and EMIs Are Supported by the SmartLogger?](#).
- Updated [G Acronyms and Abbreviations](#).

Issue 10 (2022-08-20)

- Updated [6.1.3 WebUI Menus](#).
- Updated [6.2.1 Preparations and WebUI Login](#).
- Added [6.2.4 Commissioning Using Deployment Wizard \(V300R023C00\)](#).
- Updated [6.3.6 Setting Parameters for the Slave SmartLogger](#).
- Added [6.3.7 Setting GOOSE Communications Parameters](#).
- Updated [6.3.9 Setting Inverter Parameters](#).
- Updated [6.3.10 Setting PCS Parameters](#).
- Updated [6.3.11 Setting CMU Parameters](#).
- Updated [6.3.12 Setting ESU Parameters](#).
- Updated [6.3.15 Setting HVAC Parameters](#).
- Updated [6.4 Setting Battery Control Parameters](#).
- Updated [6.3.19 Setting STS Parameters](#).
- Updated [6.7.2 Setting Active Power Control](#).
- Updated [6.7.3 Setting Reactive Power Control](#).
- Updated [7.3 Alarm Reference](#).
- Updated [7.4.4 Exporting Device Logs](#).
- Updated [7.4.11 Force Start](#).

Issue 09 (2022-01-07)

- Updated [2.1.2 Networking](#).
- Updated [2.2.2 Networking](#).
- Updated [6.1.1 WebUI Layout](#).

Updated [6.1.3 WebUI Menus](#).

Added [6.3.3 Setting Parameters for Connecting to the Management System](#).

Updated [6.3.10 Setting PCS Parameters](#).

Updated [6.3.11 Setting CMU Parameters](#).

Updated [6.3.12 Setting ESU Parameters](#).

Updated [6.3.15 Setting HVAC Parameters](#).

Updated [6.4 Setting Battery Control Parameters](#).

Added "Setting Capacity Limit".

Updated [6.5 Setting EMS Control Parameters](#).

Updated [6.7.2 Setting Active Power Control](#).

Updated [6.7.3 Setting Reactive Power Control](#).

Updated [6.7.5 Setting Export Limitation Parameters](#).

Updated [7.4.1 Upgrading the Device Firmware Version](#).

Updated [7.4.3 Sending a System Maintenance Command](#).

Updated [7.4.4 Exporting Device Logs](#).

Added [7.4.8 Managing Users](#).

Updated [7.4.9 Collecting Performance Data](#).

Updated [7.4.10 Adjusting the Total Energy Yield](#).

Updated [8.13 Which Models of Power Meters and EMIs Are Supported by the SmartLogger?](#).

Issue 08 (2021-10-15)

Updated [2.1.2 Networking](#).

Updated [2.2.2 Networking](#).

Updated [6.1.1 WebUI Layout](#).

Updated [6.1.3 WebUI Menus](#).

Updated [6.2 Device Commissioning](#).

Updated [6.2.1 Preparations and WebUI Login](#).

Added [6.2.3 Commissioning Using Deployment Wizard \(V800R021C10\)](#).

Updated [6.3.1 Setting User Parameters](#).

Updated [6.3.2 Setting Parameters for Connecting to the Management System \(V300R001C00\)](#).

Added [6.3.10 Setting PCS Parameters](#).

Added [6.3.11 Setting CMU Parameters](#).

Added [6.3.12 Setting ESU Parameters](#).
Added [6.3.13 Setting ESC Parameters](#).
Added [6.3.14 Setting ESR Parameters](#).
Added [6.3.15 Setting HVAC Parameters](#).
Added [6.4 Setting Battery Control Parameters](#).
Updated [6.7.2 Setting Active Power Control](#).
Updated [6.7.5 Setting Export Limitation Parameters](#).
Updated [7.2 Troubleshooting](#).
Updated [7.3 Alarm Reference](#).
Updated [7.4.1 Upgrading the Device Firmware Version](#).
Updated [7.4.4 Exporting Device Logs](#).
Updated [C Port No. List](#).
Updated [G Acronyms and Abbreviations](#).

Issue 07 (2021-06-30)

Updated [6.1 Introduction to WebUI](#).
Updated [6.1.3 WebUI Menus](#).
Updated [6.3.9.1 Running Parameters](#).
Added [6.3.9.4 Battery](#).
Added [6.5 Setting EMS Control Parameters](#).
Updated [6.7.2 Setting Active Power Control](#).
Updated [7.4.4 Exporting Device Logs](#).
Updated [7.4.5 Starting an Onsite Test](#).
Updated [8.13 Which Models of Power Meters and EMIs Are Supported by the SmartLogger?](#).

Issue 06 (2021-03-20)

Updated [6.3.2 Setting Parameters for Connecting to the Management System \(V300R001C00\)](#).
Updated [6.3.9.1 Running Parameters](#).
Updated [6.3.9.2 Tracking System](#).
Updated [6.3.17.1 Setting DL/T645 Meter Parameters](#).
Updated [6.3.17.2 Setting Modbus-RTU Meter Parameters](#).
Updated [6.3.18.1 Setting Modbus-RTU EMI Parameters](#).
Added [6.3.24 Smart Tracking Algorithm](#).

Updated [6.7.2 Setting Active Power Control](#).

Updated [6.7.5 Setting Export Limitation Parameters](#).

Updated [6.7.6 Setting Parameters for Smart Reactive Power Compensation](#).

Added [6.7.8 Setting Remote Shutdown](#).

Updated [6.7.8.1 Setting Dry Contact Remote Shutdown](#).

Added [6.7.8.2 Setting NS Protection Remote Shutdown](#).

Added [7.4.3.1 Exporting Full Configuration Files](#).

Added [7.4.3.2 Importing Full Configuration Files](#).

Updated [8.15 How Do I Use Mobile Network Sharing?](#).

Added [8.16 WebUI Allows Login Only in Chinese and Prompts to Switch to Chinese](#).

Issue 05 (2020-09-30)

Updated [6.3.2 Setting Parameters for Connecting to the Management System \(V300R001C00\)](#).

Updated [6.3.8 Setting MBUS Parameters](#).

Added [8.15 How Do I Use Mobile Network Sharing?](#).

Added [C Port No. List](#).

Issue 04 (2020-03-11)

Updated [6.2.1 Preparations and WebUI Login](#).

Issue 03 (2020-01-10)

Added the description about the SmartModule.

Issue 02 (2019-12-18)

Updated [6 WebUI Operations](#).

Updated [9.1 Technical Specifications of the SmartLogger](#).

Issue 01 (2019-09-24)

This issue is used for first office application (FOA).

Contents

About This Document.....	ii
1 Safety Information.....	1
1.1 Personal Safety.....	2
1.2 Electrical Safety.....	4
1.3 Environment Requirements.....	5
1.4 Mechanical Safety.....	6
2 Product Overview.....	9
2.1 SmartLogger.....	9
2.1.1 Model.....	9
2.1.2 Networking.....	11
2.1.3 Appearance.....	17
2.2 SmartModule.....	23
2.2.1 Model.....	24
2.2.2 Networking.....	25
2.2.3 Appearance.....	26
3 Device Installation.....	32
3.1 Checking Before Installation.....	32
3.2 Tools.....	32
3.3 Installation Requirements.....	33
3.4 Installing the SmartLogger.....	34
3.5 Installing the SmartLogger and SmartModule.....	36
3.6 Installing a Power Adapter.....	39
4 Cable Connections.....	41
4.1 Connecting Cables to the SmartLogger.....	41
4.1.1 Preparing Cables.....	41
4.1.2 Connecting a PE Cable.....	42
4.1.3 Connecting an RS485 Communications Cable.....	42
4.1.4 Connecting an MBUS Cable.....	44
4.1.5 Connecting a DI Signal Cable.....	47
4.1.6 Connecting the Output Power Cable.....	48
4.1.7 Connecting the AI Signal Cable.....	49
4.1.8 Connecting the DO Signal Cable.....	50

4.1.9 Connecting the Ethernet Cable.....	51
4.1.10 Connecting Fiber Jumpers.....	52
4.1.11 Installing a SIM Card and a 4G Antenna.....	53
4.1.12 Connecting the 24 V Input Power Cable.....	55
4.2 Connecting Cables to the SmartModule.....	56
4.2.1 Preparing Cables.....	56
4.2.2 Connecting the PE Cable.....	57
4.2.3 Connecting the Ethernet Cable.....	57
4.2.4 Connecting the 12 V Power Input Cable.....	58
4.2.5 Connecting the RS485 Communications Cable.....	59
4.2.6 Connecting the DI Signal Cable.....	60
4.2.7 Connecting the Output Power Cable.....	61
4.2.8 Connecting the AI Signal Cable.....	62
4.2.9 Connecting the PT Signal Cable.....	63
4.2.10 Connecting the 24 V Power Input Cable.....	64
5 System Operation.....	66
5.1 Check Before Power-on.....	66
5.2 Powering On the System.....	66
6 WebUI Operations.....	68
6.1 Introduction to WebUI.....	68
6.1.1 WebUI Layout.....	69
6.1.2 Icon Description.....	74
6.1.3 WebUI Menus.....	75
6.2 Device Commissioning.....	84
6.2.1 Preparations and WebUI Login.....	84
6.2.2 Commissioning Using Deployment Wizard (V300R001C00).....	88
6.2.3 Commissioning Using Deployment Wizard (V800R021C10).....	89
6.2.4 Commissioning Using Deployment Wizard (V300R023C00).....	93
6.3 Parameter Settings.....	112
6.3.1 Setting User Parameters.....	113
6.3.2 Setting Parameters for Connecting to the Management System (V300R001C00).....	114
6.3.3 Setting Parameters for Connecting to the Management System.....	122
6.3.4 Setting RS485 Communications Parameters.....	130
6.3.5 Setting SPPC Communications Parameters.....	132
6.3.6 Setting Parameters for the Slave SmartLogger.....	133
6.3.7 Setting GOOSE Communications Parameters.....	135
6.3.8 Setting MBUS Parameters.....	137
6.3.8.1 Setting Parameters for a Built-in MBUS Module.....	137
6.3.8.2 Setting Parameters for an External MBUS Module.....	140
6.3.8.2.1 Setting SmartMBUS CCO01A Parameters.....	141
6.3.8.2.2 Setting SmartMBUS CCO01B Parameters.....	144
6.3.9 Setting Inverter Parameters.....	147

6.3.9.1 Running Parameters.....	149
6.3.9.2 Tracking System.....	165
6.3.9.3 Characteristic Curves.....	169
6.3.9.4 Battery.....	169
6.3.10 Setting PCS Parameters.....	173
6.3.10.1 Running Parameters.....	173
6.3.10.2 Characteristic Curve.....	189
6.3.11 Setting CMU Parameters.....	190
6.3.12 Setting ESU Parameters.....	192
6.3.13 Setting ESC Parameters.....	192
6.3.14 Setting ESR Parameters.....	193
6.3.15 Setting HVAC Parameters.....	194
6.3.16 Setting PID Module Parameters.....	195
6.3.16.1 Setting PID01 Parameters.....	196
6.3.16.1.1 PID Module Running Parameters.....	197
6.3.16.1.2 PID-PVBOX Running Parameters.....	200
6.3.16.1.3 PID-SSC Running Parameters.....	201
6.3.16.2 Setting SmartPID2000 Parameters.....	201
6.3.17 Setting Meter Parameters.....	206
6.3.17.1 Setting DL/T645 Meter Parameters.....	206
6.3.17.2 Setting Modbus-RTU Meter Parameters.....	209
6.3.18 Setting EMI Parameters.....	212
6.3.18.1 Setting Modbus-RTU EMI Parameters.....	212
6.3.18.2 Setting AI EMI Parameters.....	215
6.3.19 Setting STS Parameters.....	217
6.3.20 Setting IEC103 Device Parameters.....	218
6.3.21 Setting IEC 104 Device Parameters.....	221
6.3.22 Setting Custom Device Parameters.....	223
6.3.23 Setting Parameters for Poverty Alleviation Monitoring Center.....	225
6.3.24 Smart Tracking Algorithm.....	226
6.3.25 Setting IMD Parameters.....	227
6.4 Setting Battery Control Parameters.....	228
6.5 Setting EMS Control Parameters.....	248
6.6 Setting Feature Parameters.....	254
6.7 Power Grid Scheduling.....	255
6.7.1 Power Adjustment Description.....	255
6.7.2 Setting Active Power Control.....	255
6.7.3 Setting Reactive Power Control.....	264
6.7.4 Setting Parameters For Shutdown at High Feed-in Power.....	275
6.7.5 Setting Export Limitation Parameters.....	276
6.7.6 Setting Parameters for Smart Reactive Power Compensation.....	278
6.7.7 Setting DRM Parameters.....	280

6.7.8 Setting Remote Shutdown.....	282
6.7.8.1 Setting Dry Contact Remote Shutdown.....	282
6.7.8.2 Setting NS Protection Remote Shutdown.....	283
7 Device Maintenance.....	286
7.1 Routine Maintenance.....	286
7.2 Troubleshooting.....	286
7.3 Alarm Reference.....	289
7.4 WebUI Maintenance Operations.....	289
7.4.1 Upgrading the Device Firmware Version.....	290
7.4.2 Setting Security Parameters.....	290
7.4.3 Sending a System Maintenance Command.....	291
7.4.3.1 Exporting Full Configuration Files.....	292
7.4.3.2 Importing Full Configuration Files.....	293
7.4.4 Exporting Device Logs.....	294
7.4.5 Starting an Onsite Test.....	295
7.4.6 License Management.....	296
7.4.7 Managing the SmartModule.....	297
7.4.8 Managing Users.....	298
7.4.9 Collecting Performance Data.....	299
7.4.10 Adjusting the Total Energy Yield.....	300
7.4.11 Force Start.....	300
7.4.12 Device Replacement.....	301
7.5 Device Replacement.....	302
7.5.1 Exporting Configuration Files from the SmartLogger WebUI.....	302
7.5.2 Exporting Configuration Files from the SUN2000 App.....	302
7.6 Device Disposal.....	304
8 FAQ.....	305
8.1 How Do I Connect the SmartLogger to the SUN2000 App or FusionSolar App?.....	305
8.2 How Do I Set FTP Parameters?.....	307
8.3 How Do I Set Email Parameters?.....	309
8.4 How Do I Change the SSID and Password of the Built-in WLAN?.....	311
8.5 How Do I Use DI Ports?.....	312
8.6 How Do I Use DO Ports?.....	313
8.7 How Do I Use the USB Port?.....	314
8.8 How Do I Change a Device Name?.....	317
8.9 How Do I Change the Communications Address?.....	317
8.10 How Do I Export Inverter Parameters?.....	318
8.11 How Do I Clear Alarms?.....	318
8.12 How Do I Enable the AI1 Port to Detect SPD Alarms?.....	319
8.13 Which Models of Power Meters and EMIs Are Supported by the SmartLogger?.....	319
8.14 How Do I Check the SIM Card Status?.....	323
8.15 How Do I Use Mobile Network Sharing?.....	324

8.16 WebUI Allows Login Only in Chinese and Prompts to Switch to Chinese.....	326
8.17 How Do I Identify the Meter Wiring Direction on the SmartLogger?.....	326
8.18 Resetting Password.....	327
9 Technical Specifications.....	328
9.1 Technical Specifications of the SmartLogger.....	328
9.2 Technical Specifications of the SmartModule.....	333
A Product User Lists.....	335
B Domain Name List of Management Systems.....	337
C Port No. List.....	338
D Certificate Management and Maintenance.....	340
D.1 Preconfigured Certificate Risk Disclaimer	340
D.2 Application Scenarios of Preconfigured Certificates.....	341
E Contact Information.....	342
F Digital Power Customer Service.....	344
G Acronyms and Abbreviations.....	345

1 Safety Information

Statement

Before transporting, storing, installing, operating, using, and/or maintaining the equipment, read this document, strictly follow the instructions provided herein, and follow all the safety instructions on the equipment and in this document. In this document, "equipment" refers to the products, software, components, spare parts, and/or services related to this document; "the Company" refers to the manufacturer (producer), seller, and/or service provider of the equipment; "you" refers to the entity that transports, stores, installs, operates, uses, and/or maintains the equipment.

The **Danger, Warning, Caution, and Notice** statements described in this document do not cover all the safety precautions. You also need to comply with relevant international, national, or regional standards and industry practices. **The Company shall not be liable for any consequences that may arise due to violations of safety requirements or safety standards concerning the design, production, and usage of the equipment.**

The equipment shall be used in an environment that meets the design specifications. Otherwise, the equipment may be faulty, malfunctioning, or damaged, which is not covered under the warranty. The Company shall not be liable for any property loss, personal injury, or even death caused thereby.

Comply with applicable laws, regulations, standards, and specifications during transportation, storage, installation, operation, use, and maintenance.

Do not perform reverse engineering, decompilation, disassembly, adaptation, implantation, or other derivative operations on the equipment software. Do not study the internal implementation logic of the equipment, obtain the source code of the equipment software, violate intellectual property rights, or disclose any of the performance test results of the equipment software.

The Company shall not be liable for any of the following circumstances or their consequences:

- The equipment is damaged due to force majeure such as earthquakes, floods, volcanic eruptions, debris flows, lightning strikes, fires, wars, armed conflicts, typhoons, hurricanes, tornadoes, and other extreme weather conditions.
- The equipment is operated beyond the conditions specified in this document.

- The equipment is installed or used in environments that do not comply with international, national, or regional standards.
- The equipment is installed or used by unqualified personnel.
- You fail to follow the operation instructions and safety precautions on the product and in the document.
- You remove or modify the product or modify the software code without authorization.
- You or a third party authorized by you cause the equipment damage during transportation.
- The equipment is damaged due to storage conditions that do not meet the requirements specified in the product document.
- You fail to prepare materials and tools that comply with local laws, regulations, and related standards.
- The equipment is damaged due to your or a third party's negligence, intentional breach, gross negligence, or improper operations, or other reasons not related to the Company.

1.1 Personal Safety

 **DANGER**

Ensure that power is off during installation. Do not install or remove a cable with power on. Transient contact between the core of the cable and the conductor will generate electric arcs or sparks, which may cause a fire or personal injury.

 **DANGER**

Non-standard and improper operations on the energized equipment may cause fire, electric shocks, or explosion, resulting in property damage, personal injury, or even death.

 **DANGER**

Before operations, remove conductive objects such as watches, bracelets, bangles, rings, and necklaces to prevent electric shocks.

 **DANGER**

During operations, use dedicated insulated tools to prevent electric shocks or short circuits. The dielectric withstanding voltage level must comply with local laws, regulations, standards, and specifications.

Figure 1-1 Personal protective equipment

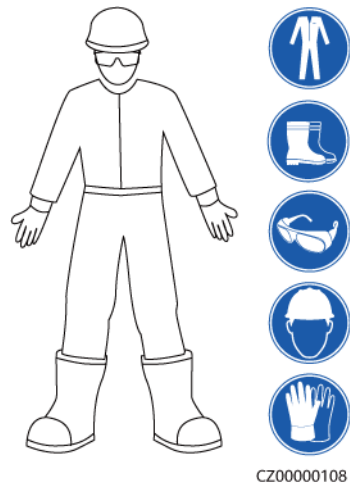

General Requirements

- Do not stop protective devices. Pay attention to the warnings, cautions, and related precautionary measures in this document and on the equipment.
- If there is a likelihood of personal injury or equipment damage during operations, immediately stop, report the case to the supervisor, and take feasible protective measures.
- Do not power on the equipment before it is installed or confirmed by professionals.
- In the case of a fire, immediately leave the building or the equipment area and activate the fire alarm or call emergency services. Do not enter the affected building or equipment area under any circumstances.

Personnel Requirements

- Only professionals and trained personnel are allowed to operate the equipment.
 - Professionals: personnel who are familiar with the working principles and structure of the equipment, trained or experienced in equipment operations and are clear of the sources and degree of various potential hazards in equipment installation, operation, maintenance
 - Trained personnel: personnel who are trained in technology and safety, have required experience, are aware of possible hazards on themselves in certain operations, and are able to take protective measures to minimize the hazards on themselves and other people
- Personnel who plan to install or maintain the equipment must receive adequate training, be able to correctly perform all operations, and understand all necessary safety precautions and local relevant standards.
- Only qualified professionals or trained personnel are allowed to install, operate, and maintain the equipment.
- Only qualified professionals are allowed to remove safety facilities and inspect the equipment.
- Personnel who will perform special tasks such as electrical operations, working at heights, and operations of special equipment must possess the required local qualifications.

- Only authorized professionals are allowed to replace the equipment or components (including software).
- Only personnel who need to work on the equipment are allowed to access the equipment.

1.2 Electrical Safety

 **DANGER**

Non-standard and improper operations may result in fire or electric shocks.

 **DANGER**

Prevent foreign matter from entering the equipment during operations. Otherwise, equipment damage, load power derating, power failure, or personal injury may occur.

 **WARNING**

For the equipment that needs to be grounded, install the ground cable first when installing the equipment and remove the ground cable last when removing the equipment.

General Requirements

- Follow the procedures described in the document for installation, operation, and maintenance. Do not reconstruct or alter the equipment, add components, or change the installation sequence without permission.
- Obtain approval from the national or local electric utility company before connecting the equipment to the grid.
- Before installing or removing power cables, turn off the switches of the equipment and its upstream and downstream switches.
- If any liquid is detected inside the equipment, disconnect the power supply immediately and do not use the equipment.
- Before performing operations on the equipment, check that all tools meet the requirements and record the tools. After the operations are complete, collect all of the tools to prevent them from being left inside the equipment.
- Before installing power cables, check that cable labels are correct and cable terminals are insulated.
- When installing the equipment, use a torque tool of a proper measurement range to tighten the screws. When using a wrench to tighten the screws, ensure that the wrench does not tilt and the torque error does not exceed 10% of the specified value.
- If the equipment has multiple inputs, disconnect all the inputs before operating the equipment.

- Check equipment connections periodically, ensuring that all screws are securely tightened.
- Only qualified professionals can replace a damaged cable.
- Do not scrawl, damage, or block any labels or nameplates on the equipment. Promptly replace labels that have worn out.
- Do not use solvents such as water, alcohol, or oil to clean electrical components inside or outside of the equipment.

Grounding

- Ensure that the grounding impedance of the equipment complies with local electrical standards.
- Ensure that the equipment is connected permanently to the protective ground. Before operating the equipment, check its electrical connection to ensure that it is reliably grounded.
- Do not work on the equipment in the absence of a properly installed ground conductor.
- Do not damage the ground conductor.
- For the equipment that uses a three-pin socket, ensure that the ground terminal in the socket is connected to the protective ground point.
- If high touch current may occur on the equipment, ground the protective ground terminal on the equipment enclosure before connecting the power supply; otherwise, electric shock as a result of touch current may occur.

Cabling Requirements

- When selecting, installing, and routing cables, follow local safety regulations and rules.
- When routing power cables, ensure that there is no coiling or twisting. Do not join or weld power cables. If necessary, use a longer cable.
- Ensure that all cables are properly connected and insulated, and meet specifications.
- Ensure that the slots and holes for routing cables are free from sharp edges, and that the positions where cables are routed through pipes or cable holes are equipped with cushion materials to prevent the cables from being damaged by sharp edges or burrs.
- Ensure that cables of the same type are bound together neatly and straight and that the cable sheath is intact. When routing cables of different types, ensure that they are away from each other without entanglement and overlapping.

1.3 Environment Requirements

 **DANGER**

Do not expose the equipment to flammable or explosive gas or smoke. Do not perform any operation on the equipment in such environments.

 **DANGER**

Do not place the equipment near heat sources or fire sources, such as smoke, candles, heaters, or other heating devices. Overheat may damage the equipment or cause a fire.

 **WARNING**

Install the equipment in an area far away from liquids. Do not install it under areas prone to condensation, such as under water pipes and air exhaust vents, or areas prone to water leakage, such as air conditioner vents, ventilation vents, or feeder windows of the equipment room. Ensure that no liquid enters the equipment to prevent faults or short circuits.

General Requirements

- Ensure that the equipment is stored in a clean, dry, and well ventilated area with proper temperature and humidity and is protected from dust and condensation.
- Keep the installation and operating environments of the equipment within the allowed ranges. Otherwise, its performance and safety will be compromised.
- Do not install, use, or operate outdoor equipment and cables (including but not limited to moving equipment, operating equipment and cables, inserting connectors to or removing connectors from signal ports connected to outdoor facilities, working at heights, performing outdoor installation, and opening doors) in harsh weather conditions such as lightning, rain, snow, and level 6 or stronger wind.
- Do not install the equipment in an environment with direct sunlight, dust, smoke, volatile or corrosive gases, infrared and other radiations, organic solvents, or salty air.
- Do not install the equipment in an environment with conductive metal or magnetic dust.
- Do not install the equipment in an area conducive to the growth of microorganisms such as fungus or mildew.
- Do not install the equipment in an area with strong vibration, noise, or electromagnetic interference.
- After installing the equipment, remove the packing materials such as cartons, foam, plastics, and cable ties from the equipment area.

1.4 Mechanical Safety

 **DANGER**

When working at heights, wear a safety helmet and safety harness or waist belt and fasten it to a solid structure. Do not mount it on an insecure moveable object or metal object with sharp edges. Make sure that the hooks will not slide off.

 **WARNING**

Ensure that all necessary tools are ready and inspected by a professional organization. Do not use tools that have signs of scratches or fail to pass the inspection or whose inspection validity period has expired. Ensure that the tools are secure and not overloaded.

 **WARNING**

Do not drill holes into the equipment. Doing so may affect the sealing performance and electromagnetic containment of the equipment and damage components or cables inside. Metal shavings from drilling may short-circuit boards inside the equipment.

General Requirements

- Do not perform operations such as arc welding and cutting on the equipment without evaluation by the Company.
- Do not install other devices on the top of the equipment without evaluation by the Company.
- Use correct tools and operate them in the correct way.

Moving Heavy Objects

- Be cautious to prevent injury when moving heavy objects.



< 18 kg
(< 40 lbs)



18–32 kg
(40–70 lbs)



32–55 kg
(70–121 lbs)

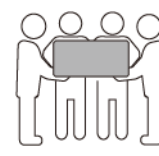

55–68 kg
(121–150 lbs)



> 68 kg
(> 150 lbs)

CZ0000110

- If multiple persons need to move a heavy object together, determine the manpower and work division with consideration of height and other conditions to ensure that the weight is equally distributed.
- If two persons or more move a heavy object together, ensure that the object is lifted and landed simultaneously and moved at a uniform pace under the supervision of one person.
- Wear personal protective gears such as protective gloves and shoes when manually moving the equipment.
- To move an object by hand, approach to the object, squat down, and then lift the object gently and stably by the force of the legs instead of your back. Do not lift it suddenly or turn your body around.
- Move or lift the equipment by holding its handles or lower kg edges. Do not hold the handles of modules that are installed in the equipment.
- Do not quickly lift a heavy object above your waist. Place the object on a workbench that is half-waist high or any other appropriate place, adjust the positions of your palms, and then lift it.

- Move a heavy object stably with balanced force at an even and low speed. Put down the object stably and slowly to prevent any collision or drop from scratching the surface of the equipment or damaging the components and cables.
- When moving a heavy object, be aware of the workbench, slope, staircase, and slippery places. When moving a heavy object through a door, ensure that the door is wide enough to move the object and avoid bumping or injury.
- When transferring a heavy object, move your feet instead of turning your waist around. When lifting and transferring a heavy object, ensure that your feet point to the target direction of movement.

2 Product Overview

2.1 SmartLogger

2.1.1 Model

Model Description

This document covers the following SmartLogger models:

- SmartLogger3000A01CN
- SmartLogger3000B01CN
- SmartLogger3000B03CN
- SmartLogger3000A01EU
- SmartLogger3000A03EU
- SmartLogger3000B02EU
- SmartLogger3000A01NH
- SmartLogger3000B00NH
- SmartLogger3000A01KR
- SmartLogger3000A01AU
- SmartLogger3000A00GL

Figure 2-1 Model

SmartLogger3000A01EU

IL04W00001

Table 2-1 Model Description

No.	Meaning	Description
1	Product family	SmartLogger3000: data collector
2	Hardware ID	<ul style="list-style-type: none"> ● A: does not support fiber networking and can connect to a maximum of 80 solar inverters. ● B: supports fiber networking and a maximum of 150 solar inverters.
3	Feature ID	<ul style="list-style-type: none"> ● 00: does not support 4G networking or MBUS communication. ● 01: supports 4G networking, but not MBUS communication. ● 02: supports MBUS communication, but not 4G networking. ● 03: supports 4G networking and MBUS communication.
4	Region	<ul style="list-style-type: none"> ● CN: China ● EU: Europe ● NH: Japan ● KR: South Korea ● AU: Australia ● GL: Global

Model Identification

You can view the SmartLogger model and communication mode on the nameplate.

Figure 2-2 Nameplate

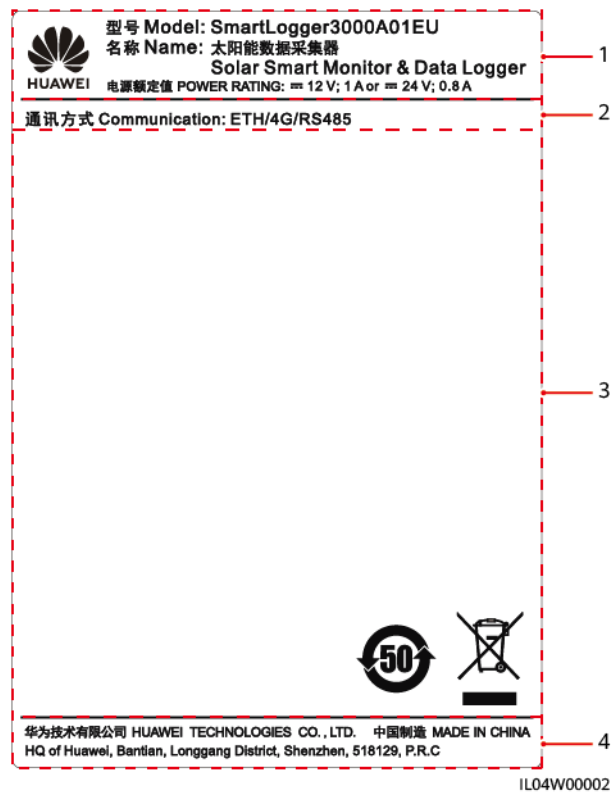

- | | |
|--|---|
| (1) Trademark, product model, and power rating | (2) Communications mode |
| (3) Compliance symbols | (4) Company name and place of manufacture |

NOTE

The nameplate figure is for reference only.

2.1.2 Networking

Functions

The SmartLogger monitors and manages PV systems and energy storage systems (ESSs). It converges all ports, converts protocols, collects and stores data, and centrally monitors and maintains the devices in the systems.

Networking Application

The SmartLogger is applicable to PV systems and ESSs. It supports the following:

- Local operations on the SmartLogger using the mobile app through the built-in WLAN.
- RS485 networking, which enables the SmartLogger to connect to:
 - Devices such as Huawei inverters and PID modules.

- Third-party inverters, environment monitoring instruments (EMIs), Smart Transformer Stations (STs), and power meters that use the Modbus RTU protocol.
- Power meters that use the DL/T645 protocol.
- Devices that use the IEC 103 protocol.
- Ethernet networking, which enables the SmartLogger to connect to the inverters, Smart Power Control System (Smart PCS), Smart String ESSs, MBUS CCO, and STs.
- MBUS networking, which enables the SmartLogger to connect to Huawei inverters and PID-PVBOXs that support MBUS communication.
- Dual-plane redundancy networking to provide reliable transmission.
- Connection to management systems:
 - Connects to a management system or third-party device that uses the Modbus TCP protocol over a wired or wireless network.
 - Connects to a management system or a third-party device that uses the IEC 104 protocol in the LAN over a wired network.
 - Connects to a management system or a third-party device that uses the GOOSE protocol over a wired network.

 **NOTE**

The SmartLogger cannot be connected to a management system that uses the IEC 104 protocol over a 4G/3G/2G or LTE dedicated network.

Typical Networking Scenarios

- The SmartLogger supports the following northbound wired networks: fiber ring network, fiber star network, and Ethernet star network.

Figure 2-3 Fiber ring network

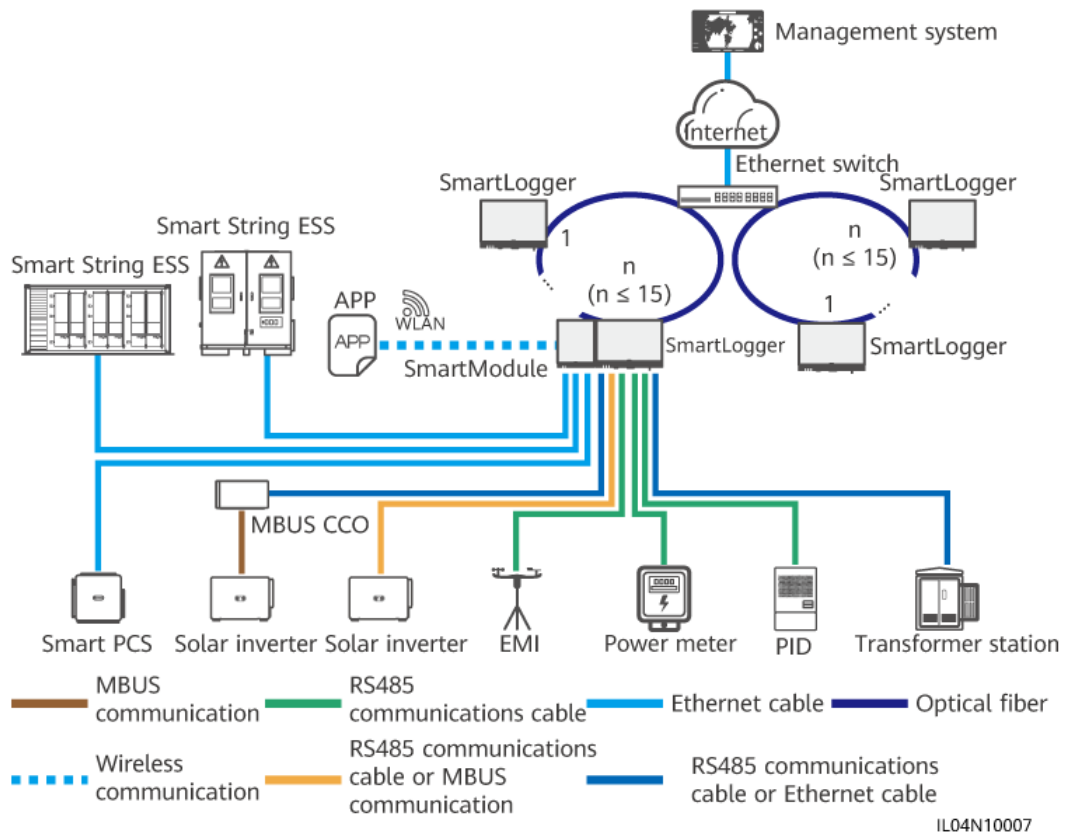

IL04N10007

NOTE

- A maximum of 15 SmartLoggers can be connected to form a fiber ring network. Each SmartLogger can connect to devices such as inverters, EMIs, and power meters.
- The fiber channel switch must support and enable the standard RSTP, and the bridge priority of the switch must be higher than 0x8000 of the SmartLogger (recommended value: 0x7000; a smaller value indicates a higher bridge priority). For details about how to configure the RSTP and bridge priority of the switch, contact the vendor. If the switch does not support the RSTP, the fiber ring topology must be changed to a chain or star topology.
- Multiple fiber ring networks can be connected to the management system over Ethernet switches.

Figure 2-4 Fiber or Ethernet star network

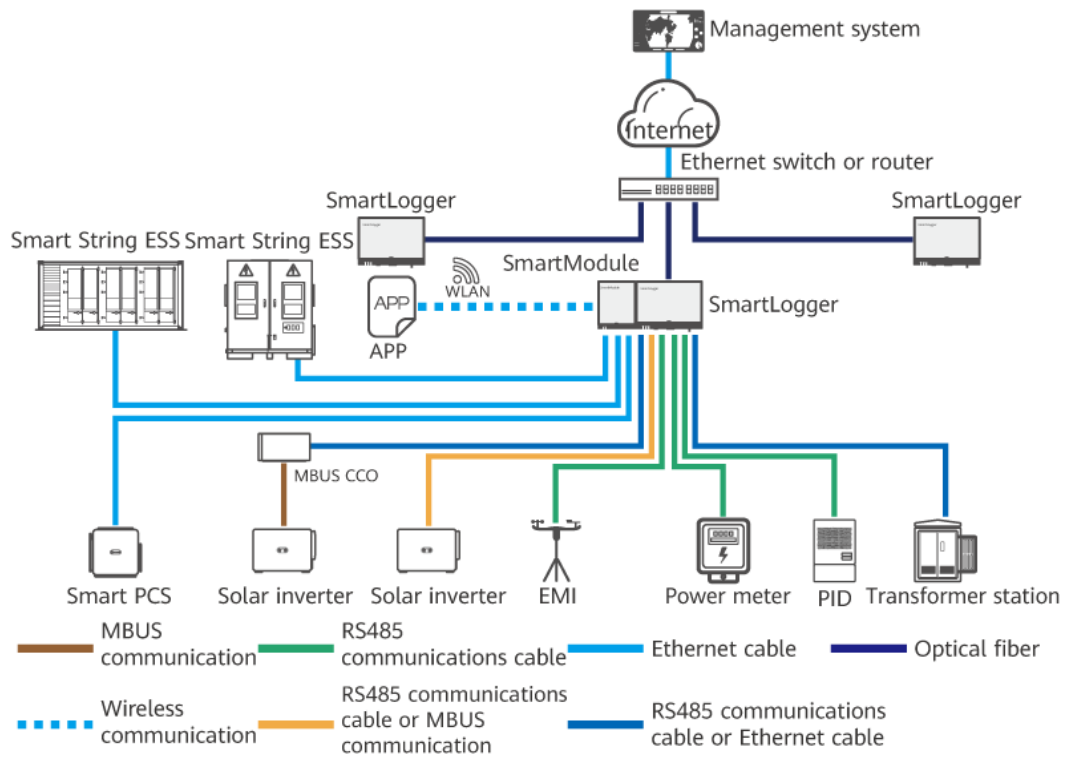

IL04N10008

NOTE

- Multiple SmartLoggers can be connected to the management system over Ethernet switches.
- When the SmartLogger connects to an Ethernet switch over optical fibers, the maximum communication distance is 12 km (with the 100M optical module) or 10 km (with the 1000M optical module). The maximum communication distance is 100 m when an Ethernet cable is used for connection.
- The SmartLogger supports the following wireless networks: 4G/3G/2G networking and LTE dedicated networking.

Figure 2-5 4G networking

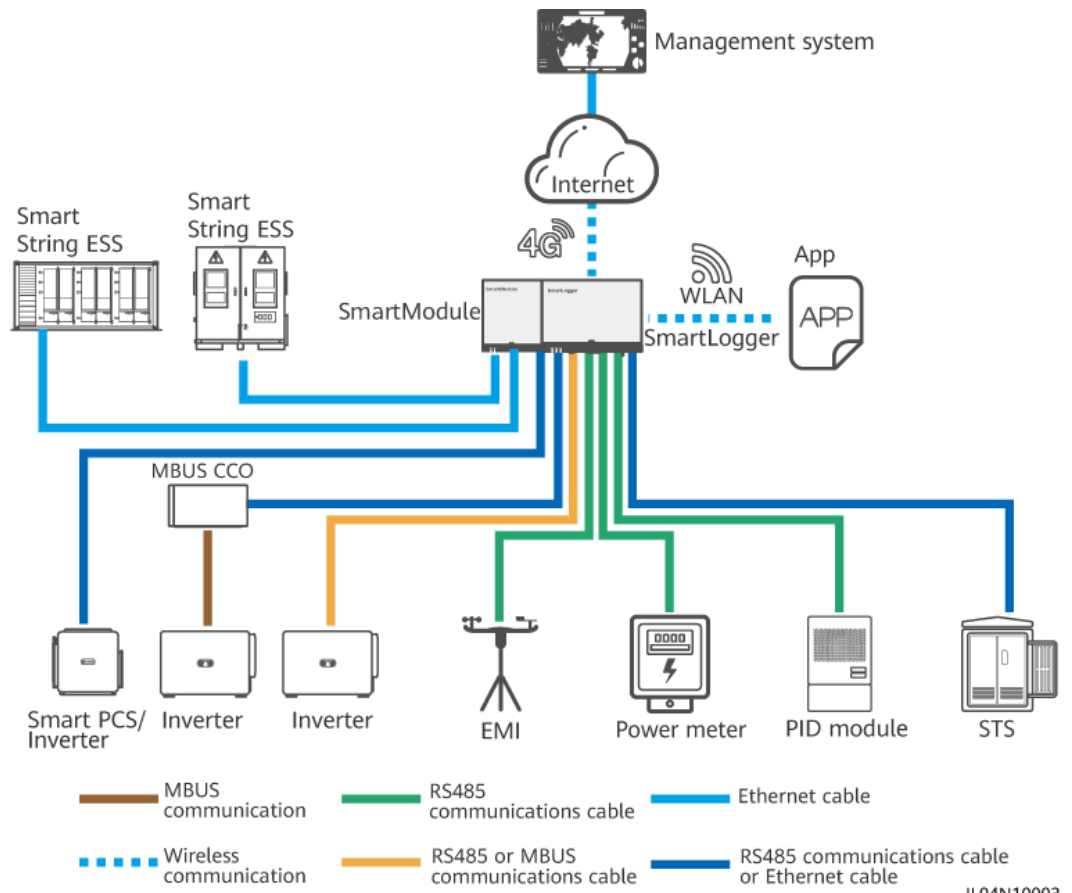
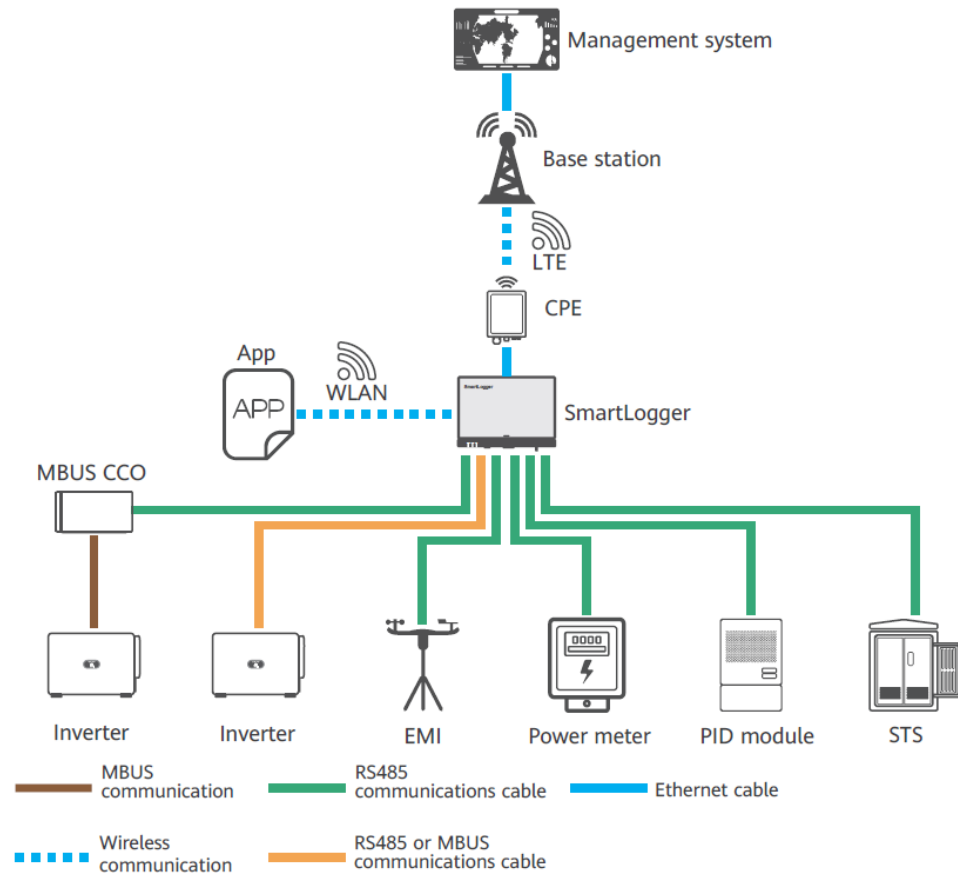

Figure 2-6 LTE dedicated networking



IL04N10008

NOTE

- The WAN port of the SmartLogger connects to the customer-premises equipment (CPE) through the power over Ethernet (PoE) module and PoE surge protective device (SPD).
- The IP addresses of the SmartLogger and CPE must be on the same network segment.

2.1.3 Appearance

Appearance

Figure 2-7 SmartLogger

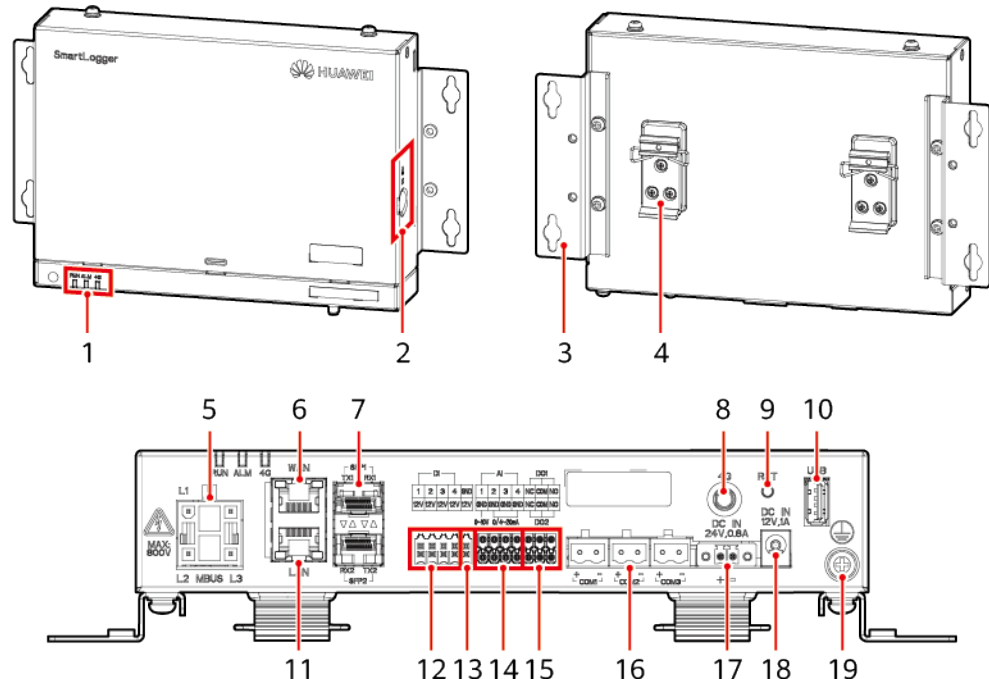



IL04W00003

- | | | |
|------------------------------|----------------------------|----------------------------|
| (1) LED indicators | (2) SIM card slot | (3) Mounting ear |
| (4) Guide rail clamp | (5) MBUS port | (6) GE port (WAN) |
| (7) SFP ports | (8) 4G antenna port | (9) RST button |
| (10) USB port | (11) GE port (LAN) | (12) DI ports |
| (13) 12 V output power port | (14) AI ports | (15) DO ports |
| (16) COM ports | (17) 24 V input power port | (18) 12 V input power port |
| (19) Protective ground point | - | - |

Indicators

Table 2-2 Indicators

Indicator	Status	Description	
Running indicator (RUN) 	Green off	The SmartLogger is not powered on.	
	Blinking green slowly (on for 1s and then off for 1s)	The communication with the management system is normal.	
	Blinking green fast (on for 0.125s and then off for 0.125s)	The communication with the management system is interrupted.	
Alarm/Maintenance indicator (ALM) 	Alarm status	Red off	No system alarm is raised.
		Blinking red slowly (on for 1s and then off for 4s)	The system raises a warning alarm.
		Blinking red fast (on for 0.5s and then off for 0.5s)	The system raises a minor alarm.
		Steady red	The system raises a major alarm.
	Maintenance status	Green off	No local maintenance is in progress.
		Blinking green slowly (on for 1s and then off for 1s)	Local maintenance is in progress.
		Blinking green fast (on for 0.125s and then off for 0.125s)	Local maintenance fails or the connection to the app is to be set up.
		Steady green	Local maintenance succeeds.
4G indicator (4G) 	Green off	The 4G/3G/2G networking function is not enabled.	
	Blinking green slowly (on for 1s and then off for 1s)	Dial-up through the 4G/3G/2G network is successful.	
	Blinking green fast (on for 0.125s and then off for 0.125s)	The 4G/3G/2G network is not connected or the communication is interrupted.	

 **NOTE**

- Local maintenance refers to the operations performed by connecting a USB flash drive to the SmartLogger USB port, such as full data import and export using a USB flash drive, and by connecting the SmartLogger to the FusionSolar app or SUN2000 app over the built-in WLAN hotspot.
- If an alarm and local maintenance happen concurrently, the alarm/maintenance indicator shows the local maintenance state first. After local maintenance ends, the indicator shows the alarm state.

Communications Ports

- GE ports: Ethernet ports, including one WAN port and one LAN port

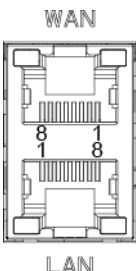
Appearance	GE Port		Description
	Pins	Pin 1	1+
		Pin 2	1-
		Pin 3	2+
		Pin 4	3+
		Pin 5	3-
		Pin 6	2-
		Pin 7	4+
		Pin 8	4-
	Indicators	Green indicator	If the indicator is steady green, the line is normal.
		Yellow indicator	If the indicator blinks yellow, data communication is normal.

- SFP ports: include two Ethernet optical ports (SFP1 and SFP2), support access of 100M/1000M SFP or eSFP optical modules, and implement ring networking using RSTP or STP.

 **NOTE**

- If RSTP is used, fiber ring protection can be completed within 10 seconds. If STP is used, fiber ring protection can be completed within 60 seconds.
- The SFP1 and SFP2 ports are Ethernet optical ports and work on the same network segment as the WAN port.

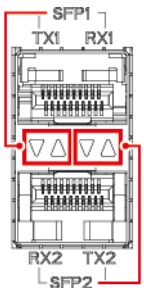
Appearance	SFP Port		Description	
	SFP1	TX1	Transmit port	
		RX1	Receive port	
	SFP2	RX2	Receive port	
		TX2	Transmit port	
	Indicators	Green indicator	If the indicator is steady green, the line is normal.	
		Yellow indicator	If the indicator blinks yellow, data communication is normal.	

- DI ports: digital input ports, which are used to connect to DI power grid scheduling commands or alarm signals.

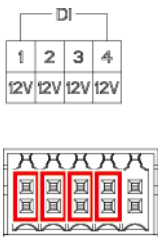
Appearance	DI Port		Description
	DI1	1	Can connect to four passive dry contact signals.
		12 V	
	DI2	2	
		12 V	
	DI3	3	
		12 V	
	DI4	4	
		12 V	

- AI ports: analog input ports, which are used to connect to AI power grid scheduling commands or environment monitoring sensors.

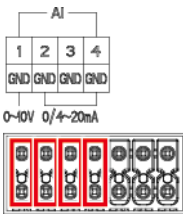
Appearance	AI Port		Description
	AI1	1	Supports one channel of voltage-type (0–10 V) AI signals.
		GND	
	AI2	2	Support three channels of current-type (0–20 mA or 4–20 mA) AI signals.
		GND	
	AI3	3	
		GND	
	AI4	4	
		GND	

- DO ports: digital output ports, supporting two relay outputs. A DO port supports a maximum of 12 V signal voltage.

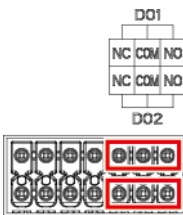
Appearance	DO Port		Description
	DO1	NC	<ul style="list-style-type: none"> • The NC/COM is a normally closed contact. • The NO/COM is a normally open contact.
		COM	
		NO	
	DO2	NC	
		COM	
		NO	

- USB port: supports USB2.0 for connecting to a USB flash drive.

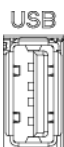
Appearance	USB Port	Description
	USB	After a USB flash drive is inserted into the USB port, you can perform local maintenance operations on the SmartLogger, such as firmware upgrade and data export.

- COM ports: RS485 communications port, supporting three independent RS485 channels and the access of devices that comply with the Modbus-RTU, IEC103, or DL/T645 protocol.

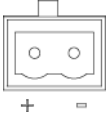
Appearance	COM Port		Description
	COM1, COM2, and COM3	+	RS485A, RS485 differential signal+
		-	RS485B, RS485 differential signal-

Power Ports

- Input power ports: There are two input power ports.

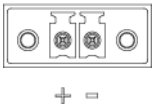
Appearance	Input Power Port		Description
DC IN 12V,1A 	12 V input power port	DC IN 12 V, 1 A	DC2.0 input port, which supports 12 V DC input and is used to connect to a power adapter.
DC IN 24V,0.8A 	24 V input power port	DC IN 24 V, 0.8 A	2-pin cord end terminal, which supports 24 V DC input. When the device connects to the power supply through the 12 V input power port, this port can be used as the 12 V output power port.

- 12 V output power port: There is one 12 V output power port. Its maximum output capability is 0.1 A. The port is used to drive the coil of the intermediate relay in the export limitation or audible and visual alarm scenario.

NOTICE

Select the intermediate relay with a free-wheeling diode in the coil. Otherwise, the device may be damaged.

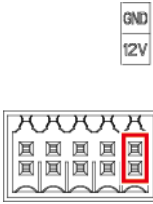
Appearance	Output Power Port		Description
	12 V output power port	GND	Power supply-
		12 V	Power supply+

Button

Button	Operation	Function Description
RST button RST 	Hold down the button for 1s to 3s.	When WLAN is set to OFF in idle state , hold down the RST button for 1s to 3s to power on the WLAN module. The alarm/maintenance indicator (ALM) then blinks green quickly for 2 minutes (other indicators are off) and the SmartLogger waits for connecting to the app. If the app is not connected, the WLAN module is automatically powered off after it is powered on for 4 hours.
	Button press duration 10s to 20s	If you hold down the RST button for 10s to 20s, the SmartLogger enters the safe mode. In this case, the device configuration parameters are retained, but personal privacy and sensitive data, including the login password and email address, are cleared.
	Hold down the button for more than 60s.	Within 3 minutes after the SmartLogger is powered on, hold down the RST button for more than 60s until all indicators are off and then wait until the RUN indicator is on. The SmartLogger restarts and restores its factory settings.

Dimensions

Figure 2-8 Dimensions

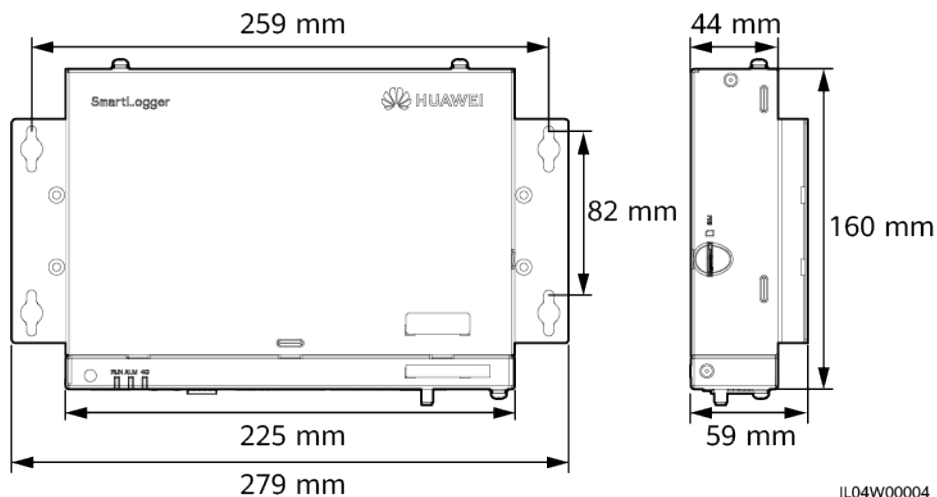

2.2 SmartModule

2.2.1 Model

Model description

This document covers the following SmartModule model:

- SmartModule1000A01

Figure 2-9 Model

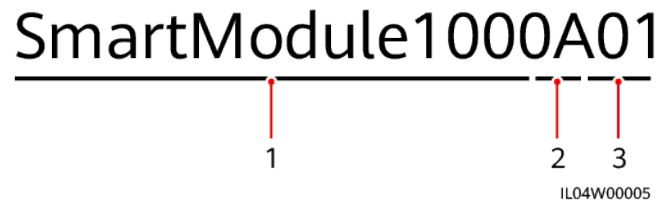

Table 2-3 Model description

No.	Meaning	Description
1	Product family	SmartModule1000: expansion module
2	Hardware ID	A: version A
3	Feature ID	01: SmartLogger scenario

Model Identification

You can view the SmartModule model on the nameplate.

Figure 2-10 Nameplate

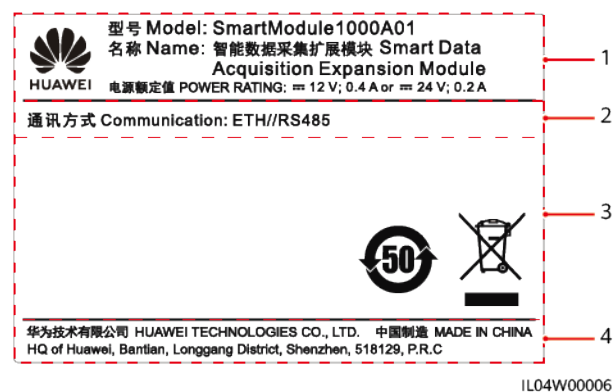

(1) Trademark, product model, and power rating

(2) Communications mode

(3) Compliance symbols

(4) Company name and place of manufacture

NOTE

The nameplate figure is for reference only.

2.2.2 Networking

Function

The SmartModule monitors and manages PV and energy storage systems. It converges ports, converts protocols, and collects data for devices in the systems, and extends ports for the SmartLogger.

Networking

The SmartModule is applicable to PV and energy storage systems. It supports the following:

- RS485 networking, which enables the SmartModule to connect to:
 - Huawei devices such as solar inverters and PID modules
 - Third-party solar inverters, environment monitoring instruments (EMIs), Smart Transformer Stations (STs), and power meters that use the Modbus-RTU protocol
 - Power meters that use the DL/T645 protocol
 - Devices that use the IEC103 protocol
- Ethernet networking, which connects to the solar inverter, Smart Power Control System (Smart PCS), Smart String Energy Storage System (ESS), and STS.
- The SmartLogger can be connected over Ethernet.

Figure 2-11 Networking

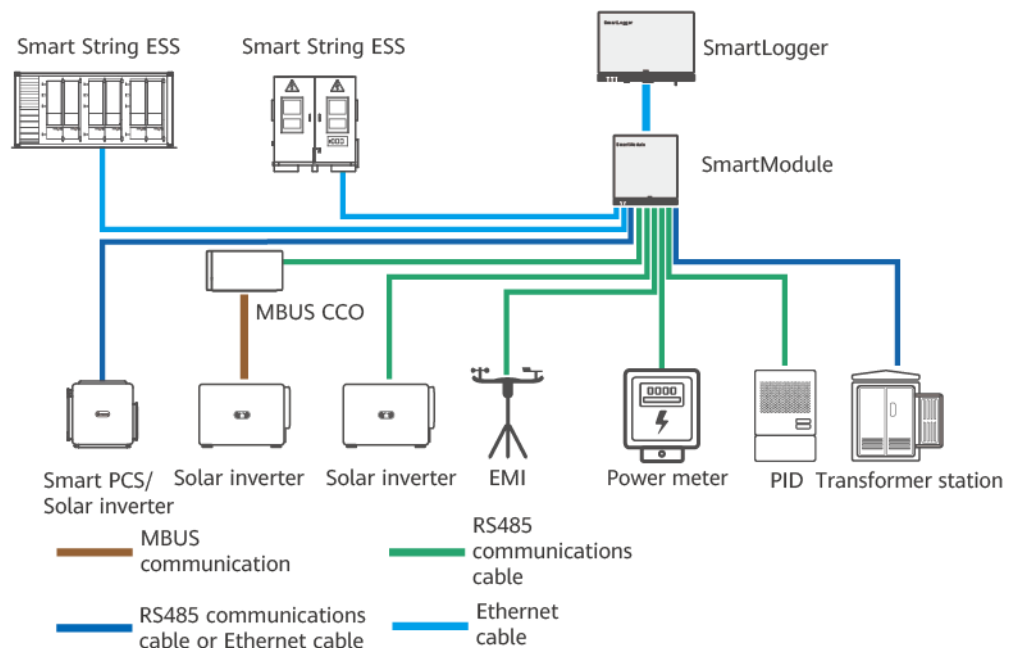

IL04N10009

2.2.3 Appearance

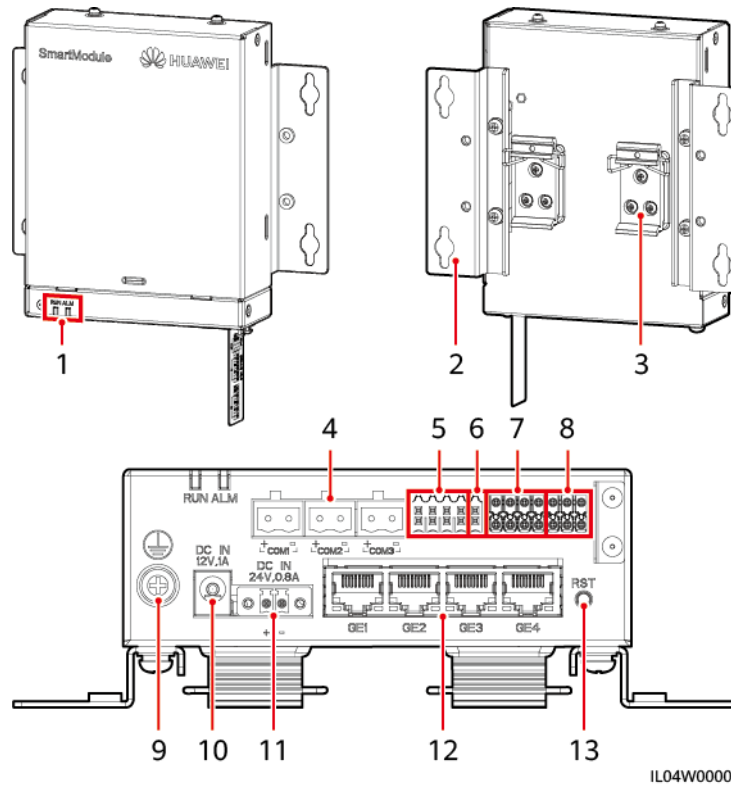

Appearance

Figure 2-12 Appearance



- | | | |
|----------------------------|----------------------------|-----------------------------|
| (1) LED indicators | (2) Mounting ear | (3) Guide rail clamp |
| (4) COM ports | (5) DI ports | (6) 12 V power output port |
| (7) AI ports | (8) PT ports | (9) Protective ground point |
| (10) 12 V power input port | (11) 24 V power input port | (12) GE ports |
| (13) RST button | - | - |

Indicators

Indicator	Status	Description	
Running indicator (RUN) 	Green off	The SmartModule is not powered on.	
	Blinking green slowly (on for 1s and then off for 1s)	The communication with the SmartLogger is normal.	
	Blinking green fast (on for 0.125s and then off for 0.125s)	The communication with the SmartLogger is interrupted.	
Alarm/Maintenance indicator (ALM) 	Alarm status	Red off	No alarm is raised for the SmartModule.
		Blinking red slowly (on for 1s and then off for 4s)	The SmartModule is running in non-encryption status.
		Blinking red fast (on for 0.5s and then off for 0.5s)	The SmartModule digital certificate is invalid.
		Steady red	Reserved.

Communications Ports

- GE ports: four Ethernet electrical ports. Connect the LAN port of the SmartLogger to one GE port of the SmartModule using an Ethernet cable. The SmartModule obtains an IP address from the DHCP server and automatically registers with the SmartLogger. The SmartLogger can use all communications ports of the SmartModule.

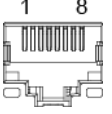
Appearance	GE Port		Description
	Pins	Pin 1	1+
		Pin 2	1-
		Pin 3	2+
		Pin 4	3+
		Pin 5	3-
		Pin 6	2-
		Pin 7	4+
		Pin 8	4-
	Indicators	Green indicator	If the indicator is steady green, the line is normal.
		Yellow indicator	If the indicator blinks yellow, data communication is normal.

- DI ports: digital input ports, which are used to connect to DI power grid scheduling commands or alarm signals.

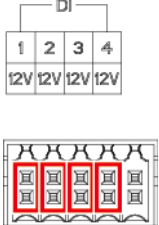
Appearance	DI Port		Description
	DI1	1	Can connect to four passive dry contact signals.
		12 V	
	DI2	2	
		12 V	
	DI3	3	
		12 V	
	DI4	4	
		12 V	

- AI ports: analog input ports, which are used to connect to AI power grid scheduling commands or environment monitoring sensors.

Appearance	AI Port		Description
	AI1	1	Supports one channel of voltage-type (0–10 V) AI signals.
		GND	
	AI2	2	Support three channels of current-type (0–20 mA or 4–20 mA) AI signals.
		GND	
	AI3	3	
		GND	
	AI4	4	
		GND	

- PT ports: can connect to two PT100/PT1000 temperature sensors.

Appearance	PT Port		Description
	PT1	+	Can connect to a three-wire or two-wire PT100/PT1000 temperature sensor.
		-	
		GND	
	PT2	+	<ul style="list-style-type: none"> • Three-wire: cable length < 2 m for PT100; cable length < 20 m for PT1000 • Two-wire: cable length < 2 m for a PT temperature sensor
		-	
		GND	

- COM ports: RS485 communications port, supporting three independent RS485 channels and the access of devices that comply with the Modbus-RTU, IEC103, or DL/T645 protocol.

Appearance	COM Port		Description
	COM1, COM2, and COM3	+	RS485A, RS485 differential signal+
		-	RS485B, RS485 differential signal-

Power Ports

- Input power ports: There are two input power ports.

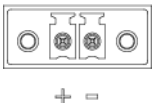
Appearance	Input Power Port		Description
<p>DC IN 12V,1A</p> 	12 V input power port	DC IN 12 V, 1 A	DC2.0 input port, which supports 12 V DC input and is used to connect to a power adapter.
<p>DC IN 24V,0.8A</p> 	24 V input power port	DC IN 24 V, 0.8 A	2-pin cord end terminal, which supports 24 V DC input. When the device connects to the power supply through the 12 V input power port, this port can be used as the 12 V output power port.

- 12 V output power port: There is one 12 V output power port. Its maximum output capability is 0.1 A. The port is used to drive the coil of the intermediate relay in the export limitation or audible and visual alarm scenario.

NOTICE

Select the intermediate relay with a free-wheeling diode in the coil. Otherwise, the device may be damaged.

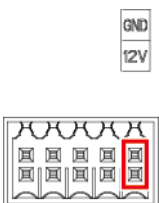
Appearance	Output Power Port		Description
	12 V output power port	GND	Power supply-
		12 V	Power supply+

Button

Button	Operation	Function Description
RST button RST 	Hold down the button for 3s to 10s.	If the Communication using expired certificate function is disabled for the SmartLogger and the digital certificate of the SmartModule becomes invalid, after enabling the function, press the RST button for 3s to 10s to enable the SmartModule to enter the mode of ignoring digital certificate expiration and restore the communication with the SmartLogger. The alarm/maintenance indicator (ALM) blinks red slowly. After the digital certificate of the SmartModule is reloaded through the SmartLogger, the SmartModule communication can recover.
	Hold down the button for more than 60s.	Within 3 minutes after the SmartModule is powered on, hold down the RST button for more than 60s until all indicators are off and then wait until the RUN indicator is on. The SmartModule restarts and restores its factory settings.

Dimensions

Figure 2-13 Dimensions

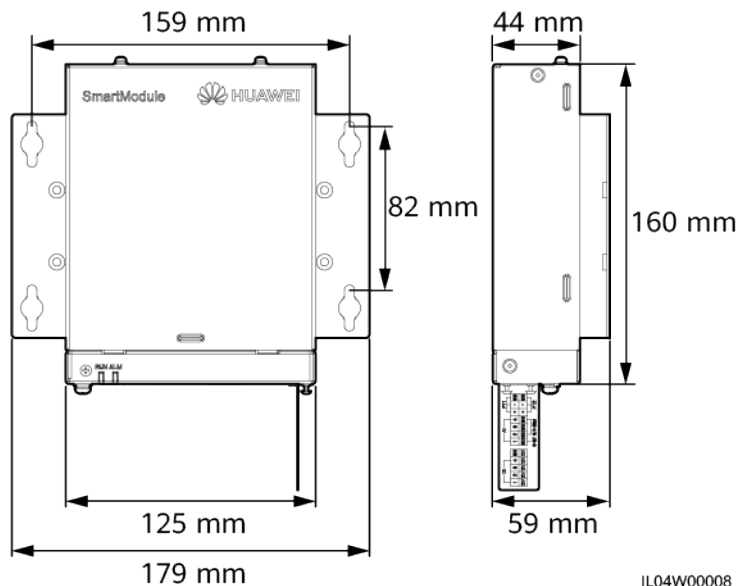









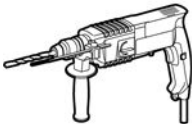
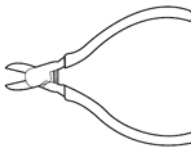
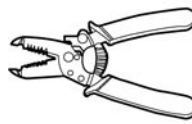
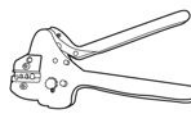
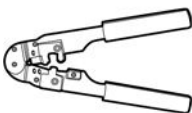

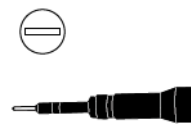





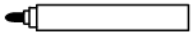

3 Device Installation

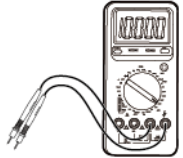
3.1 Checking Before Installation

Check Item	Criteria
Outer packaging	The outer package is intact. If it is damaged or abnormal, do not unpack it and contact your dealer.
Deliverables	Check the quantity of deliverables against the <i>Packing List</i> in the packing case. If any component is missing or damaged, contact your dealer.

3.2 Tools

Type	Tool			
Installation				
	Hammer drill	Diagonal pliers	Wire stripper	Crimping tool
				
	RJ45 crimping tool	Flat-head screwdriver	Phillips insulated torque screwdriver	Flat-head insulated torque screwdriver

Type	Tool			
	 Utility knife	 Cable cutter	 Vacuum cleaner	 Marker
	 Measuring tape	 Cable tie	 Heat gun	 Multimeter
	 Heat shrink tubing	 Level	 Rubber mallet	-
PPE	 Insulated gloves	 Safety goggles	 Dust mask	 Insulated shoes

3.3 Installation Requirements

NOTICE

- Do not install the SmartLogger in areas with flammable and explosive materials and direct sunlight.
- The SmartLogger should be installed at a proper height to facilitate operation and maintenance.

Figure 3-1 Installation position

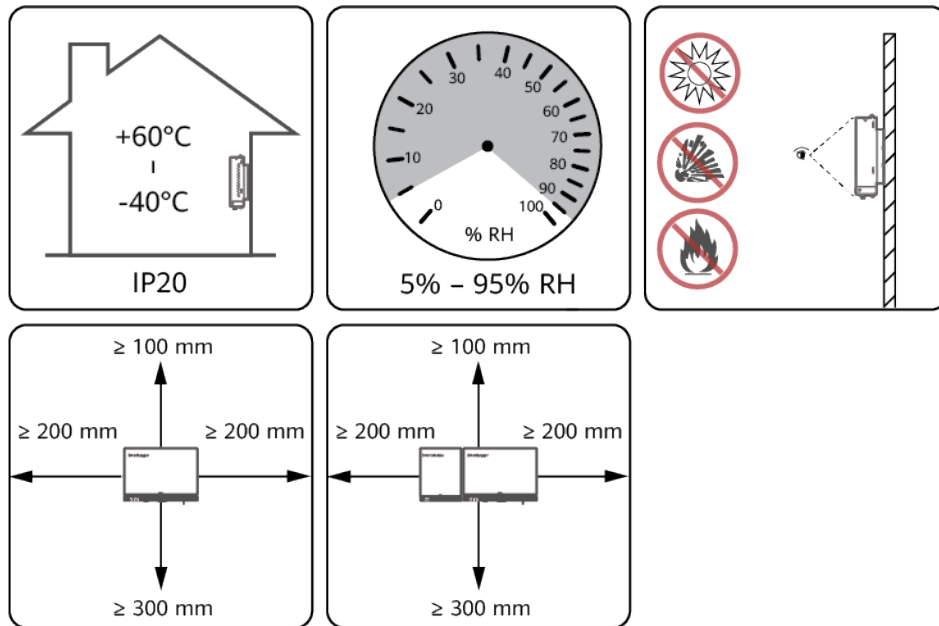

IL04Y00001

3.4 Installing the SmartLogger

The SmartLogger can be wall-mounted or guide rail-mounted.

Wall-mounted installation

WARNING

- Avoid drilling holes into the water pipes and power cables buried in the wall.
 - Install a SmartLogger on a flat and secure interior wall.
 - When wall-mounting the SmartLogger, ensure that the cable connection area faces downwards for ease of cable connection and maintenance.
 - You are advised to use the tapping screws and expansion tubes delivered with the SmartLogger.
-

Figure 3-2 Wall-mounted installation

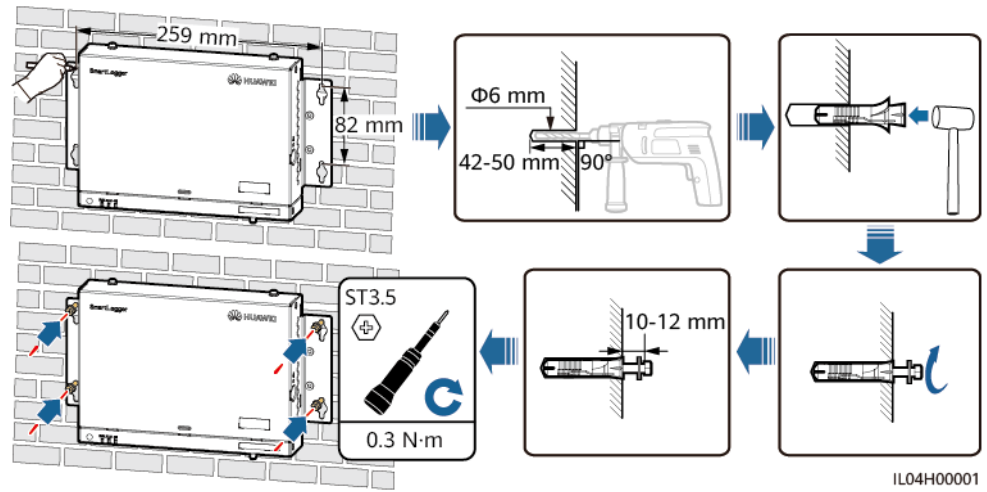

Guide Rail-mounted Installation

Prepare a 35 mm standard guide rail by yourself. Ensure that the guide rail:

- Has sufficient length for securing the SmartLogger. The recommended effective length is 230 mm or greater.
- Has been secured before you install the SmartLogger.

Figure 3-3 Guide rail-mounted installation

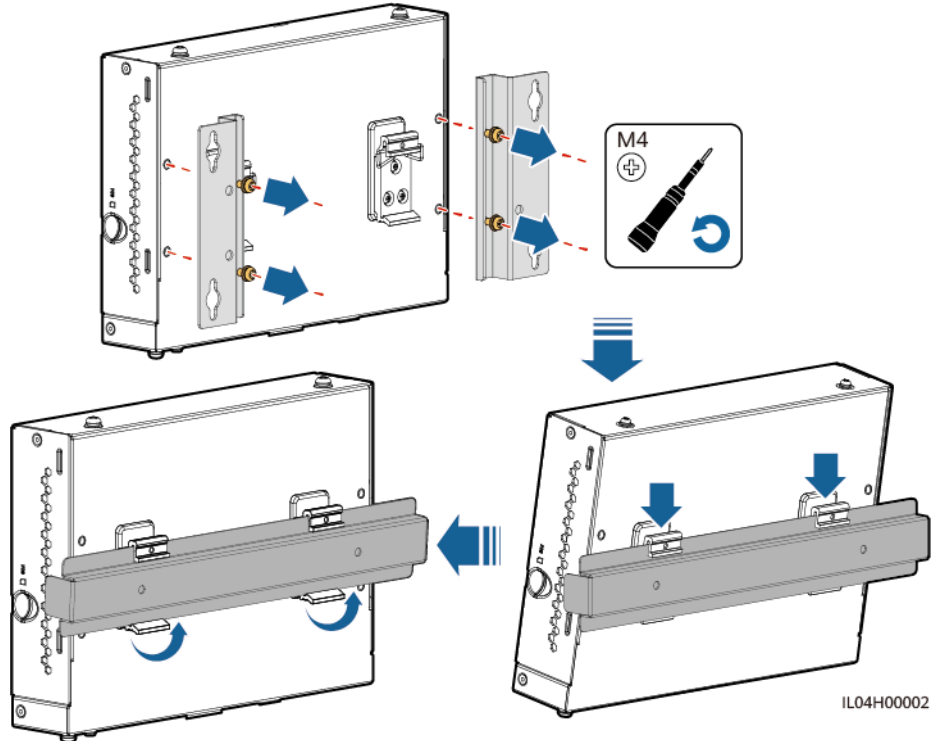

3.5 Installing the SmartLogger and SmartModule

Combine the SmartLogger and SmartModule and install them on a wall or along a guide rail.

Wall-mounted Installation

WARNING

Avoid drilling holes into the water pipes and power cables buried in the wall.

Step 1 Combine the SmartLogger and SmartModule.

NOTE

If the SmartLogger and SmartModule have been combined before delivery, skip this step.

Figure 3-4 Connecting the SmartLogger to the SmartModule using a connecting plate

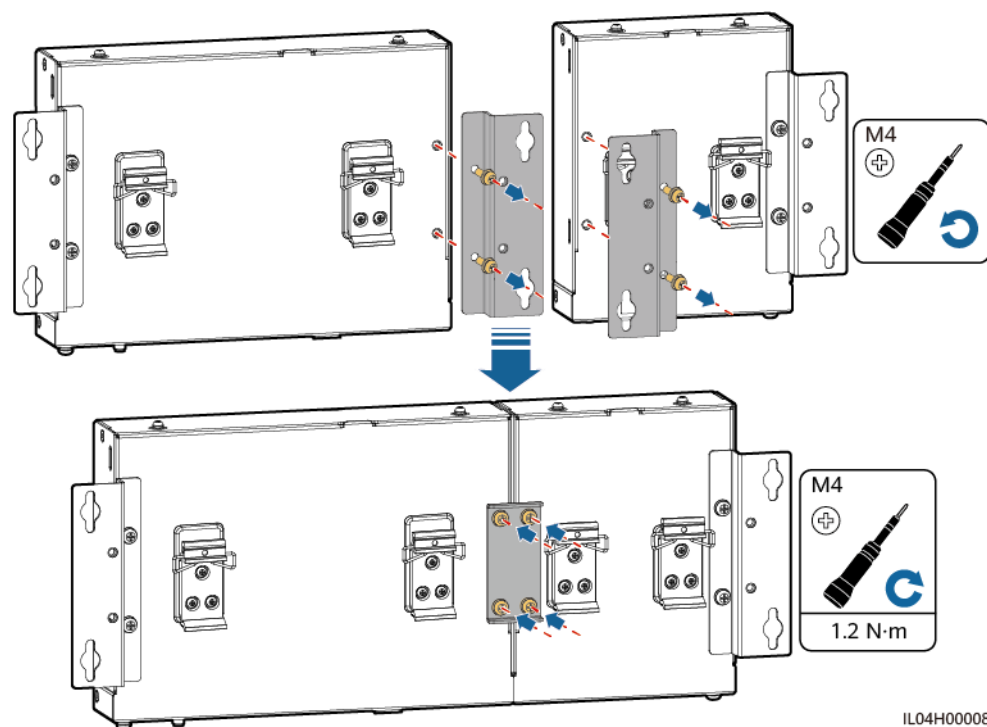

Step 2 Install the SmartLogger and SmartModule.

Figure 3-5 Wall-mounted installation

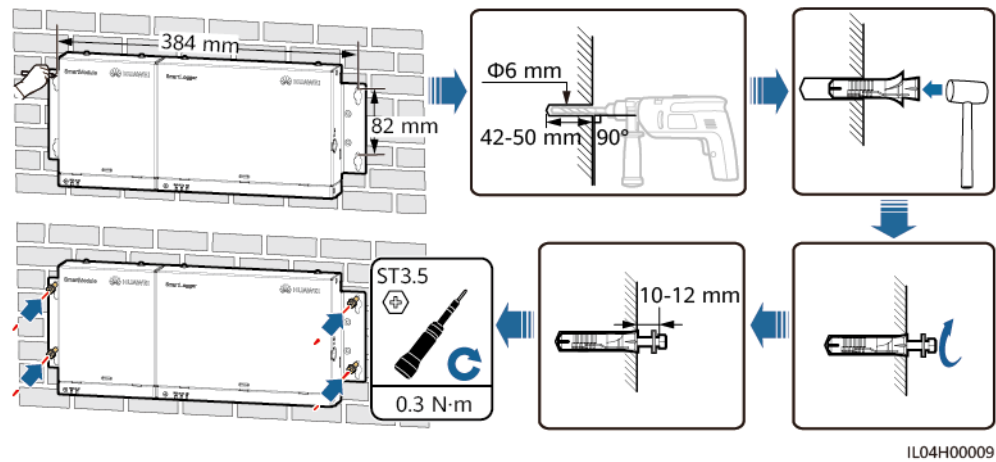

----End

Guide Rail-mounted Installation (Stand-alone)

Prepare a 35 mm standard guide rail by yourself. Ensure that the guide rail:

- Has sufficient length for securing the SmartLogger and SmartModule. The recommended effective length is 360 mm or greater.
- Has been secured before you install the SmartLogger and SmartModule.

NOTE

Ensure that the SIM card slot on the SmartLogger is not blocked.

Figure 3-6 Guide rail-mounted installation

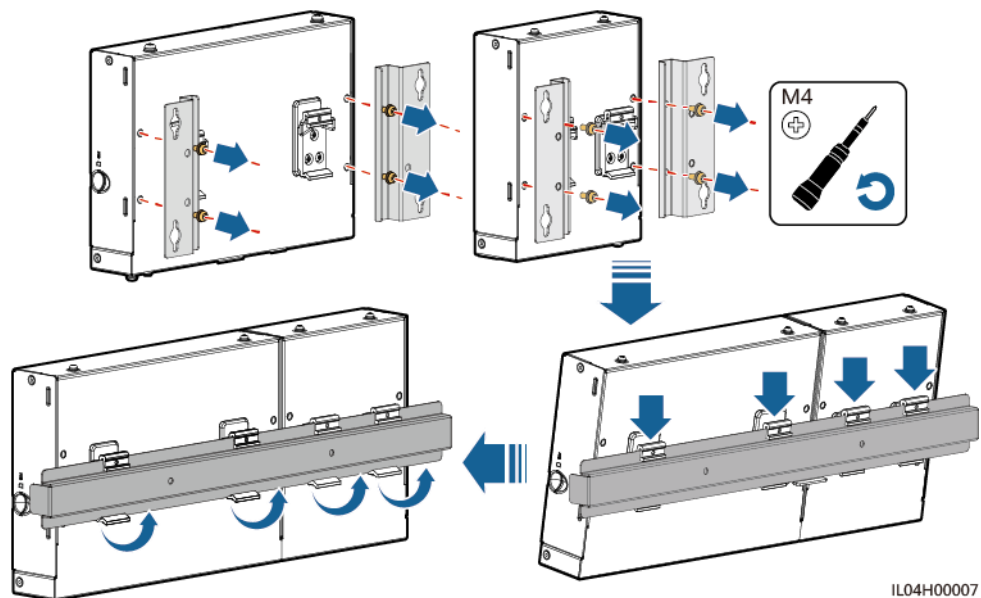

Guide Rail-mounted Installation (Combined)

Prepare a 35 mm standard guide rail by yourself. Ensure that the guide rail:

- Has sufficient length for securing the SmartLogger and SmartModule. The recommended effective length is 360 mm or greater.
- Has been secured before you install the SmartLogger and SmartModule.

 **NOTE**

Ensure that the SIM card slot on the SmartLogger is not blocked.

Step 1 Combine the SmartLogger and SmartModule.

 **NOTE**

If the SmartLogger and SmartModule have been combined before delivery, you only need to remove the mounting ears and guide rail clamps in the middle. You do not need to use a connecting plate to connect the SmartLogger and SmartModule.

Figure 3-7 Connecting the SmartLogger to the SmartModule using a connecting plate

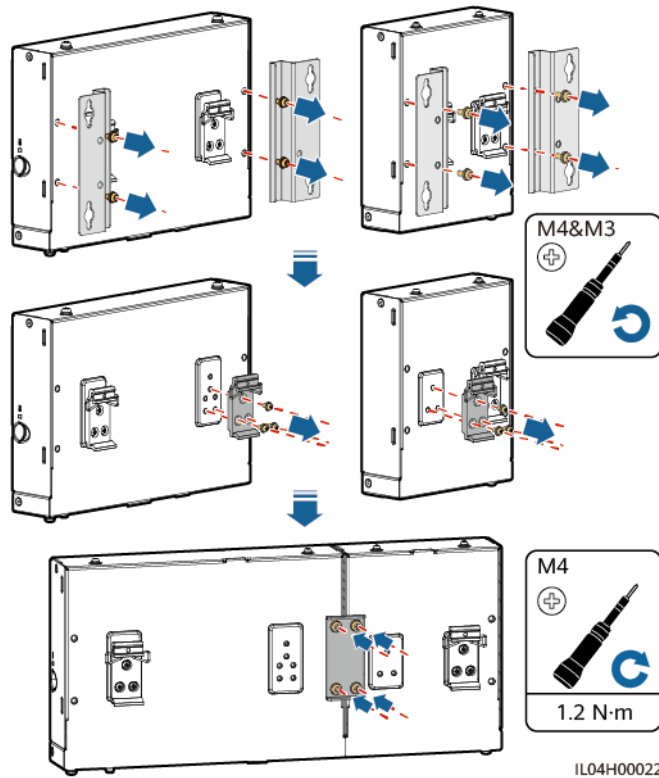

Step 2 Install the SmartLogger and SmartModule.

Figure 3-8 Guide Rail-mounted Installation

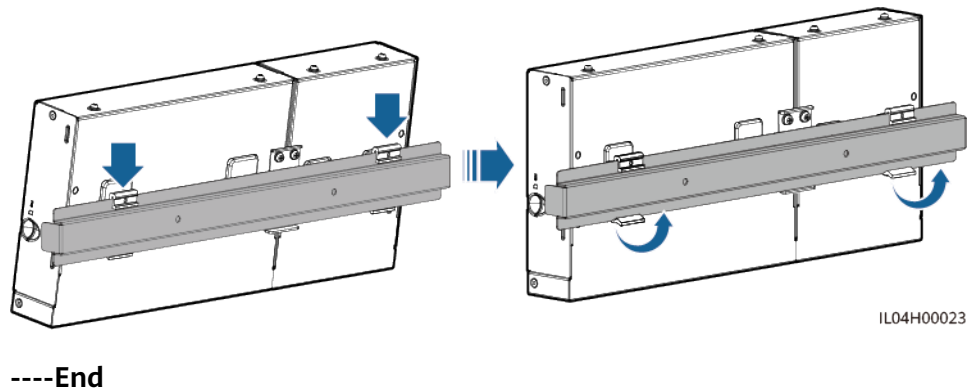

3.6 Installing a Power Adapter

A power adapter can be installed on a wall or flat surface.

If the SmartLogger requires a power adapter for power supply, install a power adapter.

Wall-mounted installation

It is recommended that the power adapter be installed on the right side of the SmartLogger. Keep the AC power cable port upward.

⚠ WARNING

Avoid drilling holes into the water pipes and power cables buried in the wall.

Figure 3-9 Wall-mounted Installation (Mode 1)

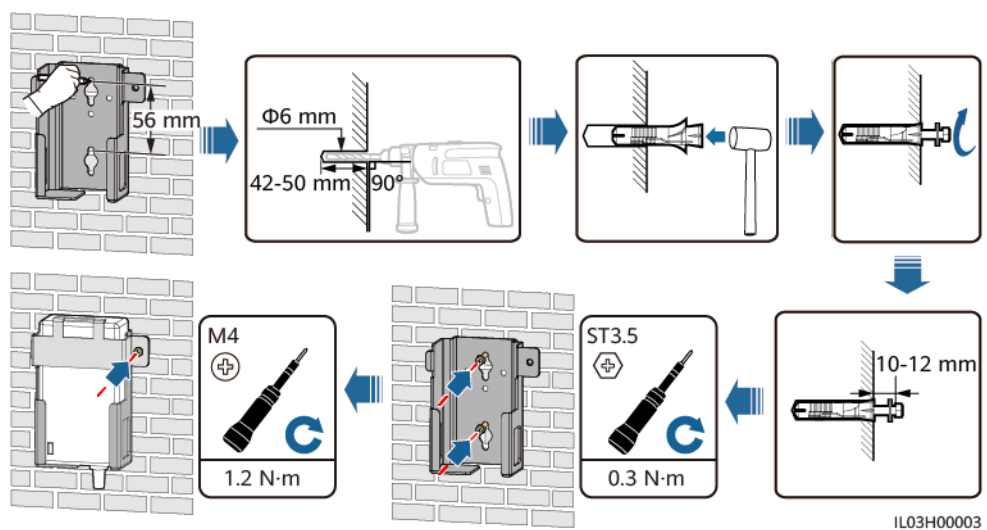
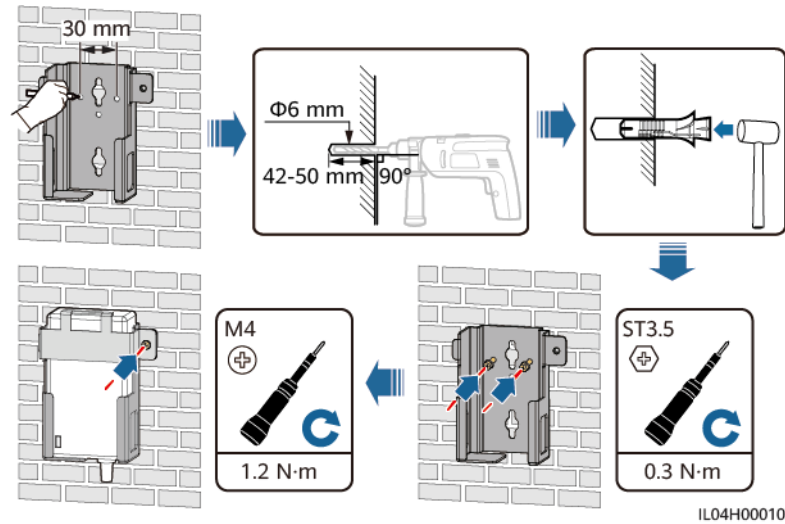

Figure 3-10 Wall-mounted Installation (Mode 2)



Flat Surface-mounted Installation

Install the power adapter on a flat surface. This section describes how to install the power adapter on the top of the SmartLogger.

Step 1 Place the power adapter horizontally on the top of the SmartLogger.

NOTICE

- Ensure that the power adapter indicator faces upward or outward.
- Ensure that the adapter is securely installed.

Step 2 Plan the cable route of the power adapter to ensure that the SIM card can be installed properly.

Figure 3-11 Flat surface-mounted installation

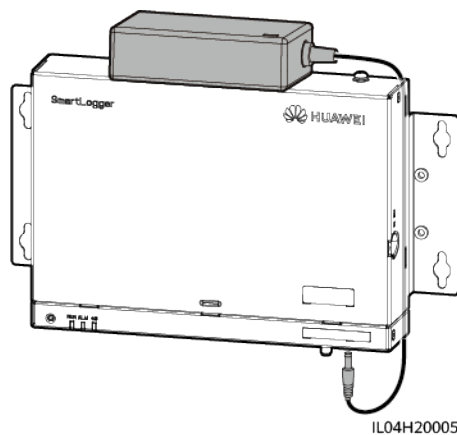

----End

4 Cable Connections

4.1 Connecting Cables to the SmartLogger

4.1.1 Preparing Cables

Type	Recommended Cable Specifications
PE cable	Outdoor copper-core cable with a cross-sectional area of 4–6 mm ² or 12–10 AWG
RS485 communications cable	Two-core or multi-core outdoor shielded cable with a cross-sectional area of 0.2–2.5 mm ² or 24–14 AWG
(Optional) MBUS cable	Delivered with the SmartLogger, 1.5 m long
DI signal cable	Two-core or multiple-core cable with a cross-sectional area of 0.2–1.5 mm ² or 24–16 AWG
Output power cable	
AI signal cable	
DO signal cable	
Network cable	Delivered with the SmartLogger, 2.2 m long. If the delivered network cable is too short, you are advised to prepare a network cable of Cat 5e or higher specifications and shielded RJ45 connectors.
(Optional) 24 V input power cable	Two-core cable with a cross-sectional area of 0.2–1.5 mm ² or 24–16 AWG

4.1.2 Connecting a PE Cable

Procedure

Step 1 Connect a PE cable.

Figure 4-1 Connecting a PE cable

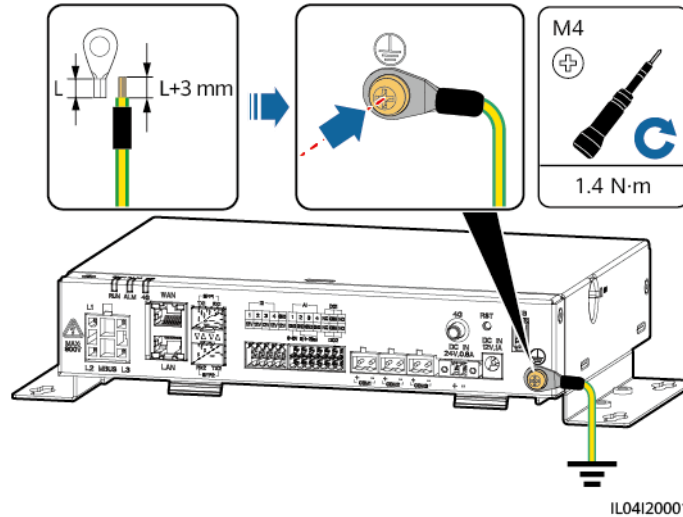

----End

4.1.3 Connecting an RS485 Communications Cable

Context

- The SmartLogger can connect to RS485 communications devices, such as a solar inverter, an environmental monitoring instrument (EMI), a power meter, and a PID over the COM port.
- Ensure that RS485+ is connected to COM+ of the SmartLogger and RS485- is connected to the COM- of the SmartLogger.

Procedure

Step 1 Connect an RS485 communications cable.

Figure 4-2 Connecting an RS485 communications cable

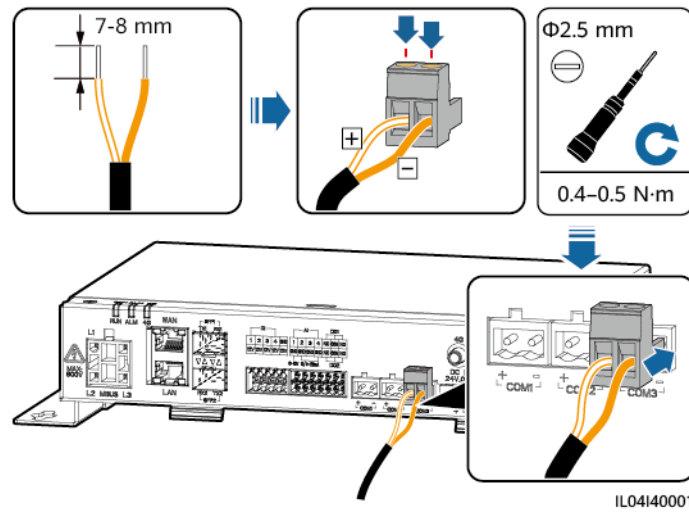

Port	Silk Screen	Description
COM1, COM2, and COM3	+	RS485A, RS485 differential signal+
	-	RS485B, RS485 differential signal-

Step 2 If devices need to be cascaded, cascade the devices and then connect them to the SmartLogger.

NOTICE

- You are advised to connect fewer than 30 devices to each RS485 route.
- The baud rate, communications protocol, and parity mode of all devices on an RS485 cascading link must be the same as those of the COM port on the SmartLogger.

Figure 4-3 Cascading connection

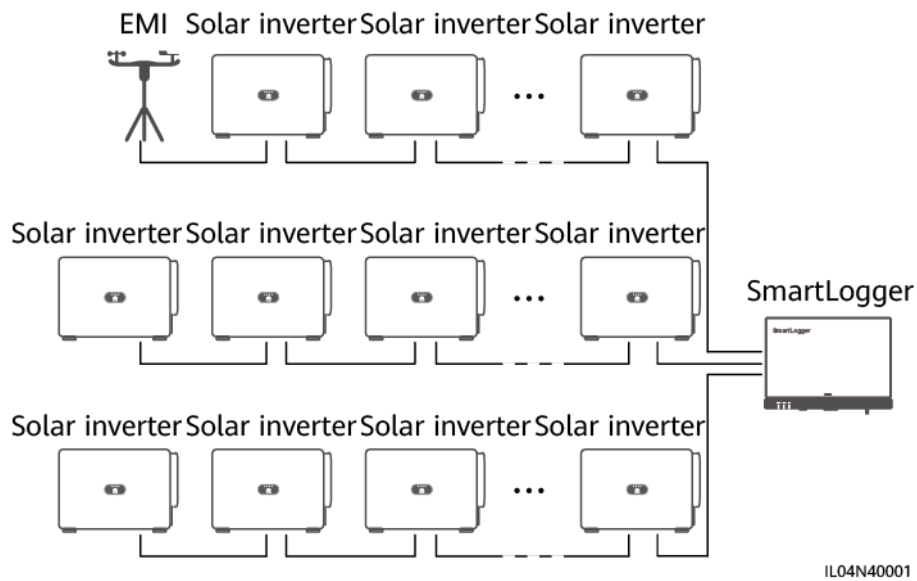

----End

4.1.4 Connecting an MBUS Cable

Context

- If both the SmartLogger and the solar inverter support MBUS, the SmartLogger can be connected to the solar inverter through an AC power cable. In this case, you do not need to connect the RS485 communications cable to the solar inverter.
- If the SmartLogger uses an AC power cable as the communications cable, an MCB and a knife fuse switch need to be installed to prevent device damage in the case of short circuits.

NOTICE

The rated power of the PV system connected to the MBUS port on the SmartLogger must be greater than 75 kW.

Figure 4-4 MBUS networking

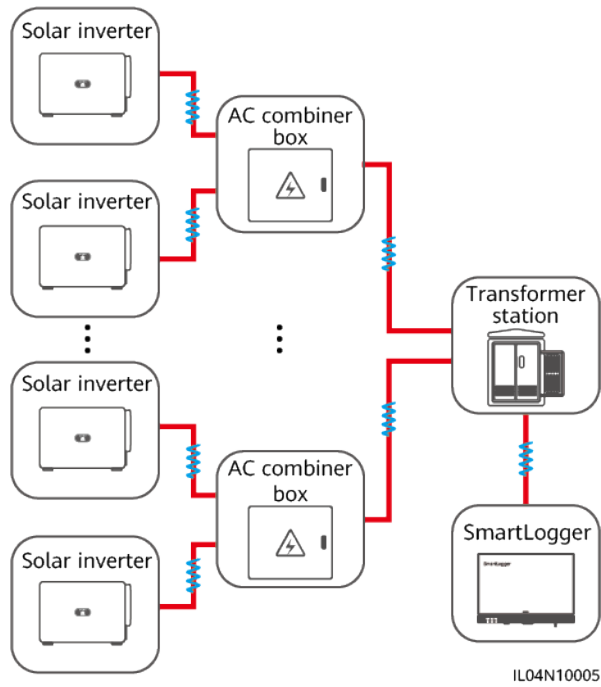

Procedure

Step 1 Connect an MBUS cable.

Figure 4-5 Connecting an MBUS Cable

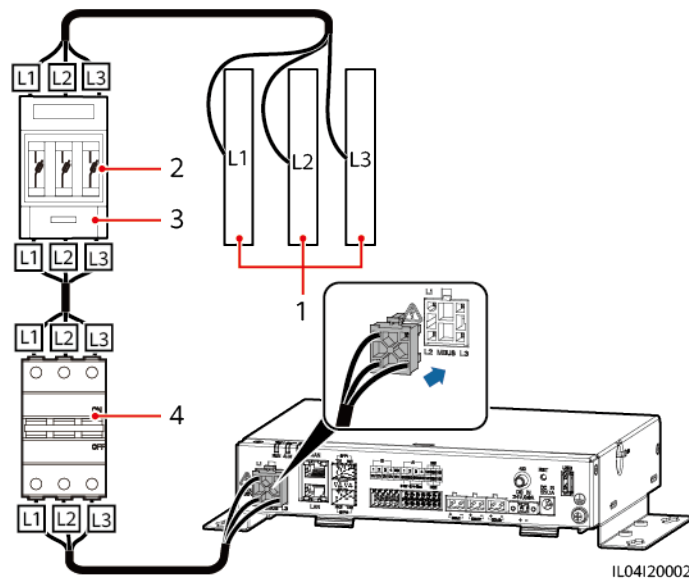

Table 4-1 Components

No.	Component	Specifications	Quantity
1	Busbar L1/L2/L3	N/A	1

No.	Component	Specifications	Quantity
2	Fuse	<ul style="list-style-type: none"> • When the rated AC voltage on the low-voltage side of the box-type transformer is less than or equal to 500 V, the rated voltage should be greater than or equal to 500 V; when the rated AC voltage on the low-voltage side of the box-type transformer is greater than 500 V and less than or equal to 800 V, the rated voltage should be greater than or equal to 800 V • When the rated AC voltage on the low-voltage side of the box-type transformer is less than or equal to 500 V, the rated current should be greater than or equal to 6 A; when the rated AC voltage on the low-voltage side of the box-type transformer is greater than 500 V and less than or equal to 800 V, the rated current should be greater than or equal to 32 A 	3
3	Knife fuse switch box	<ul style="list-style-type: none"> • When the rated AC voltage on the low-voltage side of the box-type transformer is less than or equal to 500 V, the rated voltage should be greater than or equal to 500 V; when the rated AC voltage on the low-voltage side of the box-type transformer is greater than 500 V and less than or equal to 800 V, the rated voltage should be greater than or equal to 800 V • When the rated AC voltage on the low-voltage side of the box-type transformer is less than or equal to 500 V, the rated current should be greater than or equal to 6 A; when the rated AC voltage on the low-voltage side of the box-type transformer is greater than 500 V and less than or equal to 800 V, the rated current should be greater than or equal to 32 A; number of poles: 3 	1

No.	Component	Specifications	Quantity
4	MCB	<ul style="list-style-type: none"> • When the rated AC voltage on the low-voltage side of the box-type transformer is less than or equal to 500 V, the rated voltage should be greater than or equal to 500 V; when the rated AC voltage on the low-voltage side of the box-type transformer is greater than 500 V and less than or equal to 800 V, the rated voltage should be greater than or equal to 800 V • When the rated AC voltage on the low-voltage side of the box-type transformer is less than or equal to 500 V, the rated current is greater than or equal to 6 A and less than or equal to 32 A; when the rated AC voltage on the low-voltage side of the box-type transformer is greater than 500 V and less than or equal to 800 V, the rated current is 32 A 	1

----End

4.1.5 Connecting a DI Signal Cable

Context

The SmartLogger can receive DI signals such as remote power grid scheduling commands and alarms over DI ports. It can only receive passive dry contact signals. It is recommended that the signal transmission distance be less than or equal to 10 m.

Procedure

Step 1 Connect a DI signal cable.

Figure 4-6 Connecting a DI signal cable

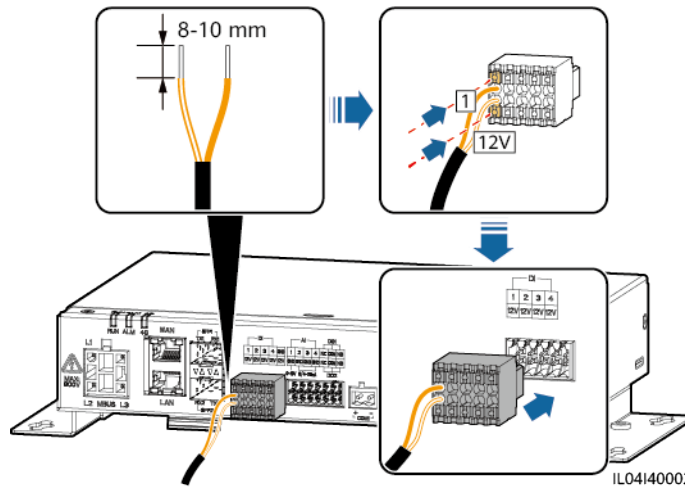

Port		Silk Screen	Description
DI	DI1	1	Can connect to four passive dry contact signals.
		12 V	
	DI2	2	
		12 V	
	DI3	3	
		12 V	
	DI4	4	
		12 V	

----End

4.1.6 Connecting the Output Power Cable

Context

In the export limitation or audible and visual alarm scenario, the SmartLogger can drive the coil of the intermediate relay through the 12 V output power port. It is recommended that the transmission distance be less than or equal to 10 m.

Procedure

Step 1 Connect the output power cable.

Figure 4-7 Connecting the output power cable

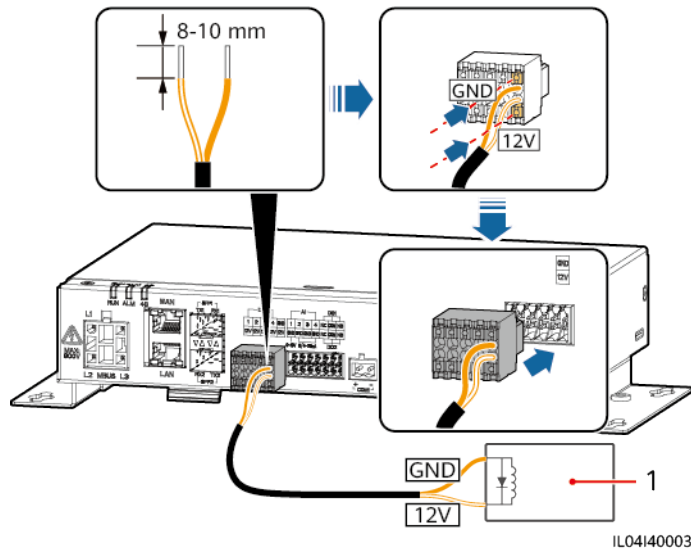

(1) Intermediate relay

----End

4.1.7 Connecting the AI Signal Cable

Context

The SmartLogger can receive AI signals from EMIs over AI ports. It is recommended that the signal transmission distance be less than or equal to 10 m.

Procedure

Step 1 Connect the AI signal cable.

Figure 4-8 Connecting the AI signal cable

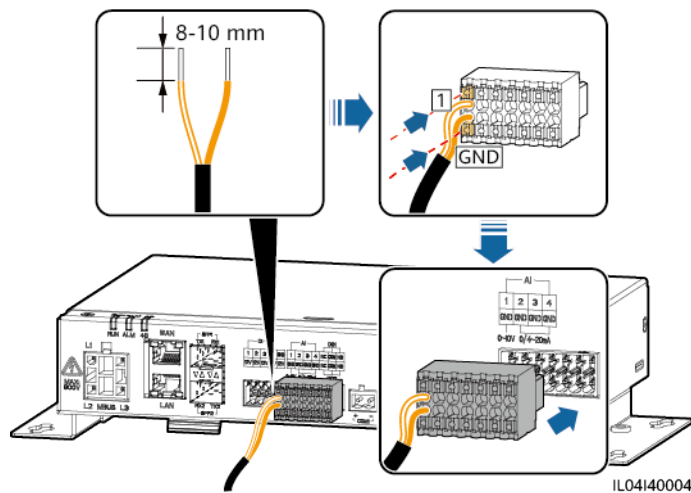

Port		Silk Screen	Description
AI	AI1	1	Supports 0–10 V input voltage.
		GND	
	AI2	2	Support 0–20 mA or 4–20 mA input current.
		GND	
	AI3	3	
		GND	
	AI4	4	
		GND	

 **NOTE**

AI ports 1, 2, 3, and 4 are for AI+ signals, and the GND port is for AI- signals.

----End

4.1.8 Connecting the DO Signal Cable

Context

The DO port supports a maximum of 12 V signal voltage. The NC/COM is a normally closed contact, while the NO/COM is a normally open contact. It is recommended that the signal transmission distance be less than or equal to 10 m.

Procedure

Step 1 Connect the DO signal cable.

Figure 4-9 Connecting a DO Signal Cable

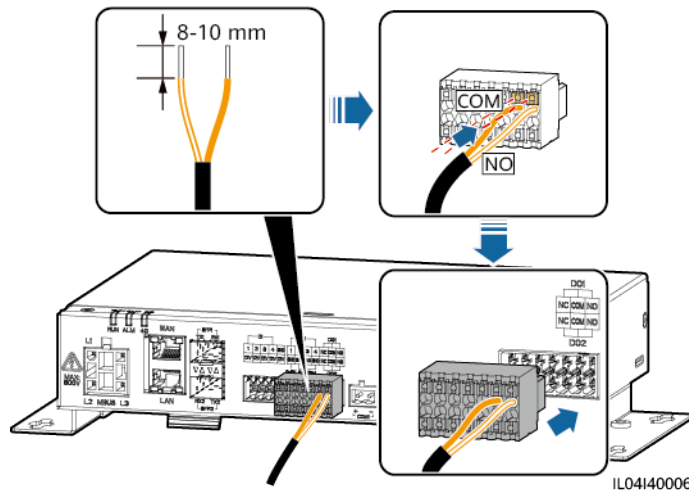

----End

4.1.9 Connecting the Ethernet Cable

Context

- The SmartLogger can connect to an Ethernet switch, router, or PC over a WAN port.
- The SmartLogger can be connected to the SmartModule or a PC over the LAN port.

Procedure

Step 1 Connect the Ethernet cable.

NOTE

When crimping the network cable, ensure that the shielding layer of the cable is securely connected to the metal shell of the RJ45 connectors.

Figure 4-10 Connecting an Ethernet cable

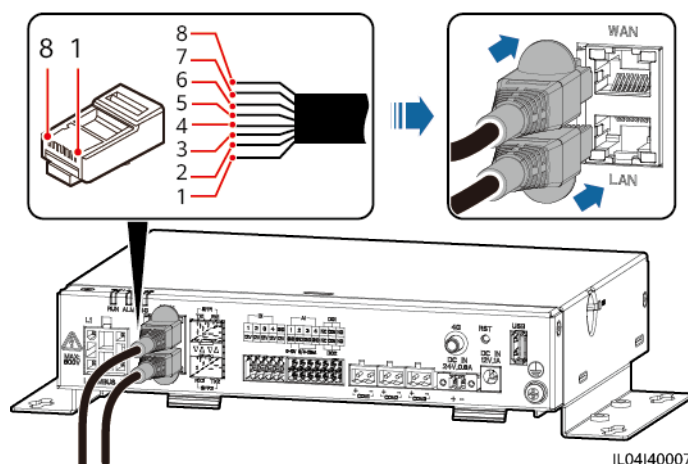

- | | | | |
|----------------------|------------|---------------------|-----------|
| (1) White-and-orange | (2) Orange | (3) White-and-green | (4) Blue |
| (5) White-and-blue | (6) Green | (7) White-and-brown | (8) Brown |

----End

4.1.10 Connecting Fiber Jumpers

Context

The SmartLogger can connect to devices such as the ATB through optical fibers.

Procedure

- Step 1** Insert optical modules into the SFP1 and SFP2 ports of the SmartLogger.

NOTICE

- Optical modules are optional. Configure the 100M or 1000M optical module based on the peer port of the optical switch. SFP or eSFP optical modules should be used. The transmission distance supported by the 100M optical module should be greater than or equal to 12 km, and the transmission distance supported by the 1000M optical module should be greater than or equal to 10 km.
- When inserting an optical module into the SFP1 port, verify that the side with a label faces upward. When inserting an optical module into the SFP2 port, verify that the side with a label faces downward.
- In dual-plane redundancy networking, SFP1 and SFP2 can connect to the northbound monitoring system (IEC104) of the SmartLogger at the same time.

- Step 2** Connect the fiber jumpers delivered with the optical modules to the ports on the optical modules.

Figure 4-11 Connecting fiber jumpers

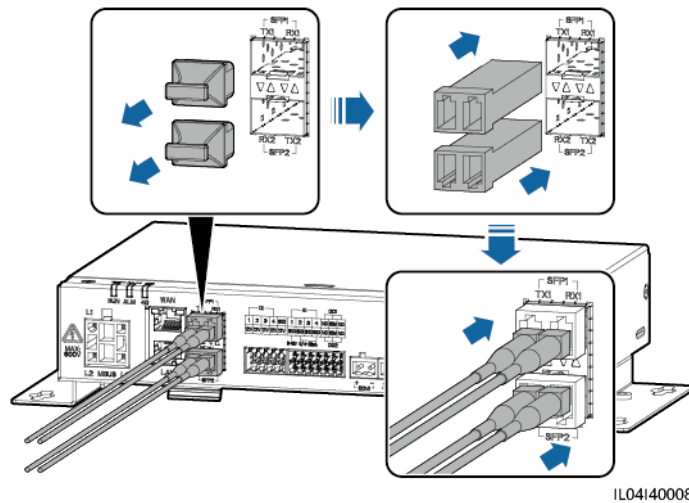

----End

Follow-up Procedure

Disconnection can be performed in reverse order.

NOTE

- When removing a fiber jumper, press down the clip first.
- When removing an optical module, pull it out by the handle. Ensure that the interval between removing and inserting an optical module is greater than 0.2s.

4.1.11 Installing a SIM Card and a 4G Antenna

Context

The SmartLogger provides the 4G wireless communication function. A SIM card of the local carrier can be inserted for dial-up access.

Prepare a standard SIM card (dimensions: 25 mm x 15 mm; capacity \geq 64 KB) Monthly data package of the SIM card \geq Monthly data of the inverters + Monthly data of the EMIs + Monthly data of the optimizers If other devices are connected to the SmartLogger in the network, the monthly data package of the SIM card needs to be increased as required.

Table 4-2 SIM card data package recommendation (residential scenario)

Management System	Recommended Monthly SIM Card Data Package			Data Baseline
FusionSolar Smart PV Management System (SmartPVMS)	Inverter	Without power meters or batteries	10 MB + 4 MB x Number of inverters	<ul style="list-style-type: none"> Device performance data can be updated every 5 minutes. Logs of the inverters and I-V diagnosis can be exported monthly. The inverters can be upgraded monthly.
		With power meters	10 MB + 7 MB x Number of inverters	
		With LUNA2000-(5-30)-S0 batteries	13 MB + 7 MB x Number of inverters + 5 MB x Number of power control modules	
	Environmental monitoring instrument (EMI)		3 MB x Number of EMIs	
	Optimizer		2 MB + 0.2 MB x Number of optimizers	

Table 4-3 SIM card data package recommendation (C&I scenario)

Management System	Recommended Monthly SIM Card Data Package			Data Baseline
FusionSolar SmartPVMS	Inverter		3 MB + 15 MB x Number of inverters	<ul style="list-style-type: none"> Device performance data can be updated every 5 minutes. Logs of the inverters, PCSs, ESSs, and I-V diagnosis can be exported monthly. The inverters, PCSs, and ESSs can be upgraded monthly. If the SmartLogger needs to be upgraded monthly, an addition of 80 MB data is required.
	EMI		3 MB x Number of EMIs	
	Optimizer		2 MB + 0.3 MB x Number of optimizers	
	ESS (including PCS)	LUNA2000-200KWH-2H1	80 MB + 80 MB x Number of ESSs	
		LUNA2000-2.0MWH-2H1	80 MB + 650 MB x Number of ESSs	

Management System	Recommended Monthly SIM Card Data Package		Data Baseline
	Power meter	3 MB x Number of power meters	

Procedure

Step 1 Insert a SIM card into the SIM card slot.

NOTICE

- When installing the SIM card, determine its installation direction based on the silk screen.
- Press the SIM card in place to lock it. In this case, the SIM card is correctly installed.
- When removing the SIM card, push it inward to eject it.

Step 2 Install an antenna.

Figure 4-12 Installing a SIM card and antenna

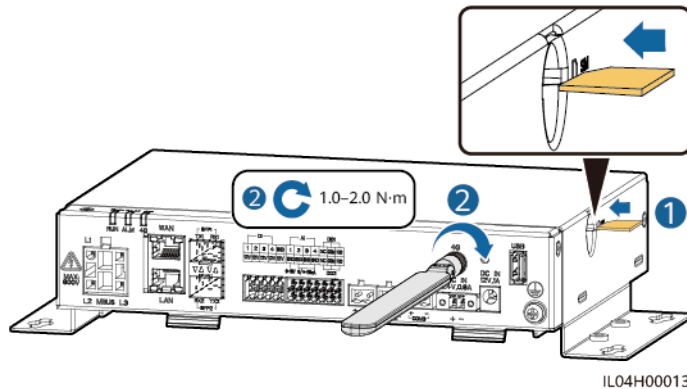

----End

4.1.12 Connecting the 24 V Input Power Cable

Context

The 24 V input power cable needs to be connected in the following scenarios:

- Scenario 1: The 24 V DC power supply is used.
- Scenario 2: The SmartLogger connects to the power supply through the 12 V input power port, and the 24 V input power port functions as the 12 V output power port to supply power to devices.

Procedure

Step 1 Connect the input power cable.

Figure 4-13 Connecting the input power cable

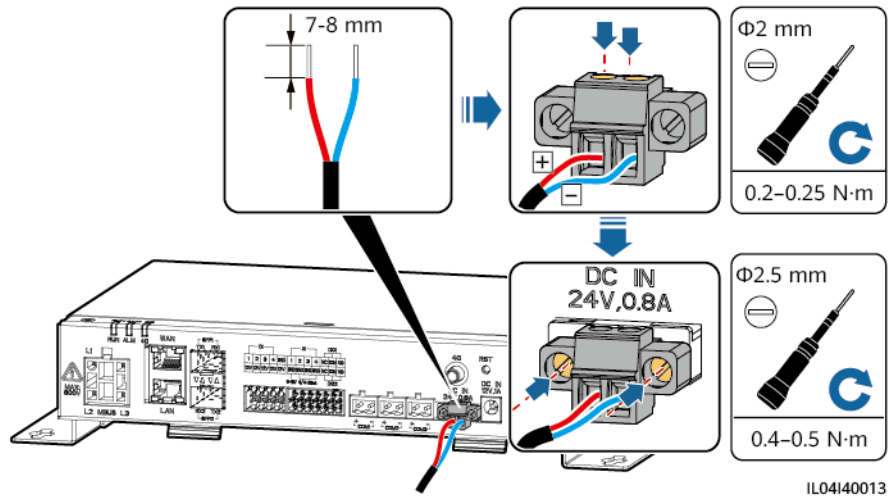

----End

4.2 Connecting Cables to the SmartModule

4.2.1 Preparing Cables

Type	Recommended Cable Specifications
PE cable	Outdoor copper-core cable with a cross-sectional area of 4–6 mm ² or 12–10 AWG
Network cable	The cable is delivered with the SmartModule and is 0.35 m long. If the delivered network cable is too short, you are advised to prepare a network cable of Cat 5e or higher specifications and shielded RJ45 connectors.
12 V power input cable	The cable is delivered with the SmartModule and is 0.5 m long.
RS485 communications cable	Two-core or multi-core outdoor shielded cable with a cross-sectional area of 0.2–2.5 mm ² or 24–14 AWG
DI signal cable	Two-core or multiple-core cable with a cross-sectional area of 0.2–1.5 mm ² or 24–16 AWG
Output power cable	
AI signal cable	
PT signal cable	For details about the cables and cable connection operations, see the documents delivered with the PT100/PT1000.

Type	Recommended Cable Specifications
(Optional) 24 V power input cable	Two-core cable with a cross-sectional area of 0.2–1.5 mm ² or 24–16 AWG

4.2.2 Connecting the PE Cable

Procedure

Step 1 Connect the PE cable.

Figure 4-14 Connecting a PE cable

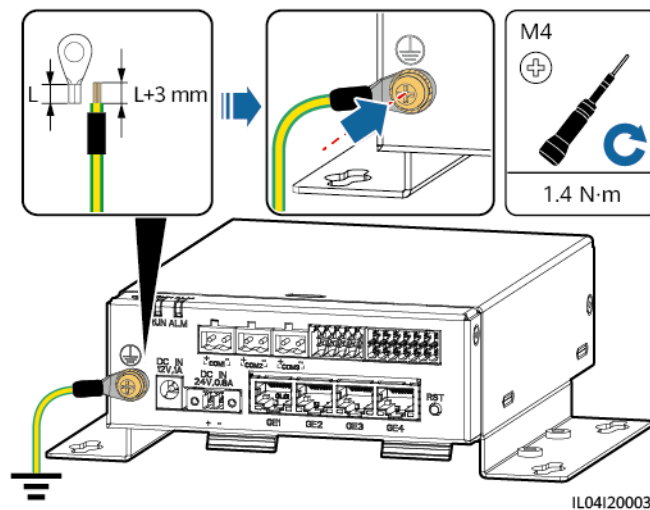

NOTE

If the SmartLogger is connected to the SmartModule over a connecting plate, connect a PE cable to the ground point of the SmartLogger or SmartModule based on site requirements.

----End

4.2.3 Connecting the Ethernet Cable

Context

- The SmartModule can be connected to the SmartLogger and a PC over the GE port.
- Connect the LAN port of the SmartLogger to one of the GE ports (GE1 and GE4 recommended) of the SmartModule through an Ethernet cable. The SmartModule obtains an IP address from the DHCP server and automatically registers with the SmartLogger.

Procedure

Step 1 Connect the Ethernet cable.

 NOTE

When crimping the network cable, ensure that the shielding layer of the cable is securely connected to the metal shell of the RJ45 connectors.

Figure 4-15 Connecting an Ethernet Cable

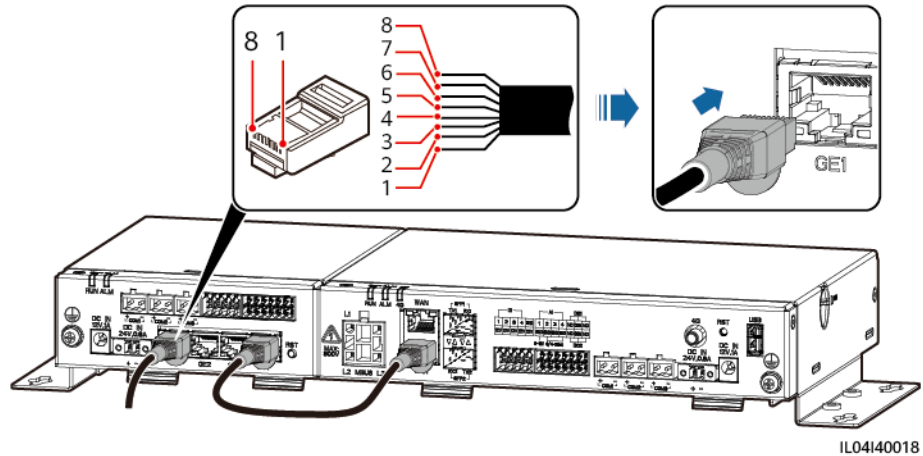

- | | | | |
|----------------------|------------|---------------------|-----------|
| (1) White-and-orange | (2) Orange | (3) White-and-green | (4) Blue |
| (5) White-and-blue | (6) Green | (7) White-and-brown | (8) Brown |

----End

4.2.4 Connecting the 12 V Power Input Cable

Context

The SmartLogger connects to the power supply through the 12 V power input port, and the 24 V power input port of the SmartLogger functions as the 12 V power output port to supply power to the SmartModule.

Procedure

- Step 1** Connect the 12 V power input cable.

Figure 4-16 Connecting the 12 V power input cable

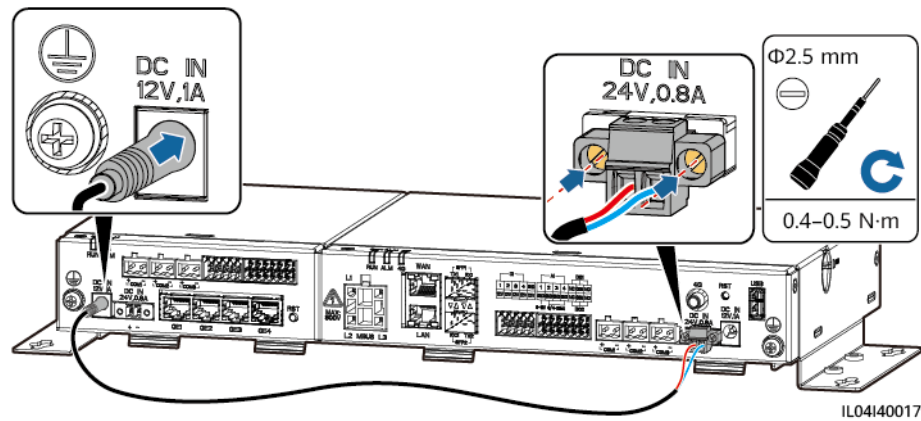

----End

4.2.5 Connecting the RS485 Communications Cable

Context

- The SmartModule can connect to RS485 communications devices, such as a solar inverter, an EMI, a power meter, and a PID over COM ports.
- Ensure that RS485+ is connected to COM+ of the SmartModule and RS485- is connected to the COM- of the SmartModule.

Procedure

Step 1 Connect the RS485 communications cable.

Figure 4-17 Connecting an RS485 communications cable

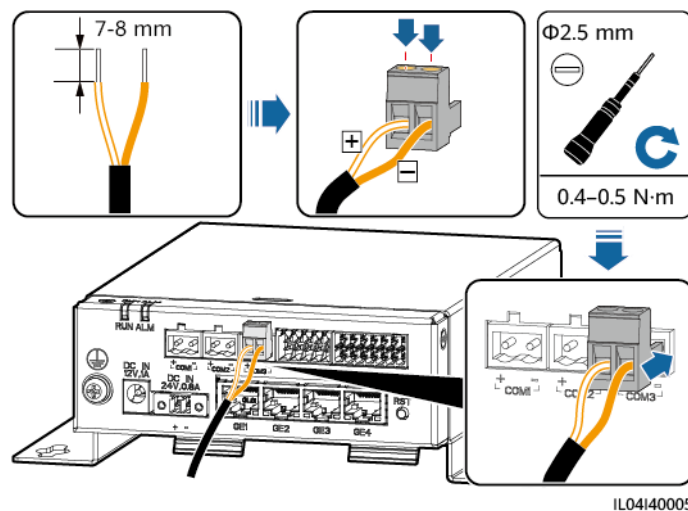

Port	Silk Screen	Description
COM1, COM2, and COM3	+	RS485A, RS485 differential signal+

Port	Silk Screen	Description
	-	RS485B, RS485 differential signal-

Step 2 If devices need to be cascaded, cascade the devices and then connect them to the SmartModule.

NOTICE

- You are advised to connect fewer than 30 devices to each RS485 route.
- The baud rate, communications protocol, and parity mode of all devices on an RS485 cascading link must be the same as those of the COM port of the SmartModule.

Figure 4-18 Cascading connection

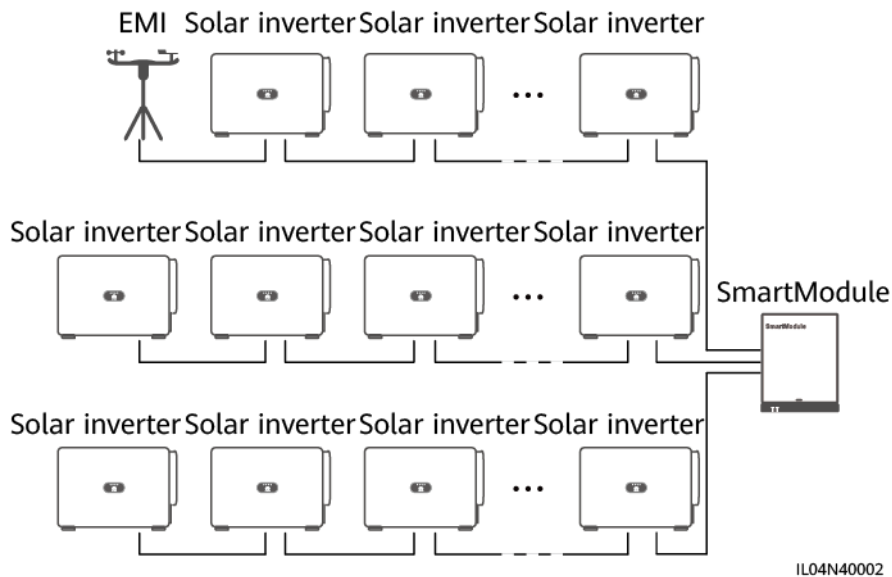

----End

4.2.6 Connecting the DI Signal Cable

Context

The SmartModule can receive DI signals such as remote commands and alarms over DI ports. It can only receive passive dry contact signals. It is recommended that the signal transmission distance be less than or equal to 10 m.

Procedure

Step 1 Connect the DI signal cable.

Figure 4-19 Connecting the DI signal cable

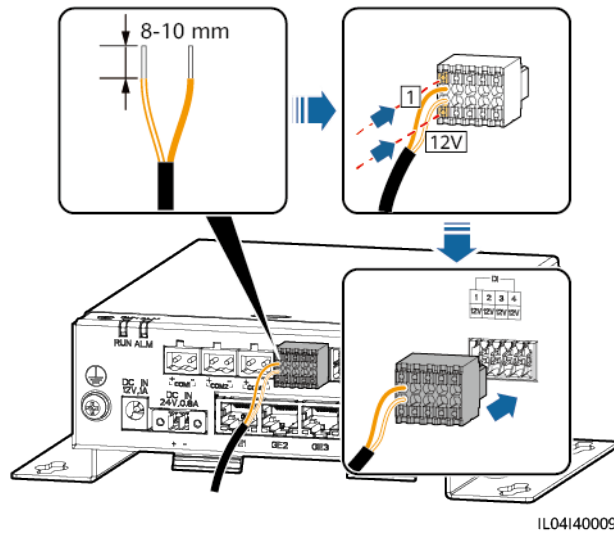

Port		Silk Screen	Description
DI	DI1	1	Can connect to four passive dry contact signals.
		12 V	
	DI2	2	
		12 V	
	DI3	3	
		12 V	
	DI4	4	
		12 V	

----End

4.2.7 Connecting the Output Power Cable

Context

In the export limitation or audible and visual alarm scenario, the SmartModule can drive the coil of the intermediate relay through the 12 V power output port. It is recommended that the transmission distance be less than or equal to 10 m.

Procedure

Step 1 Connect the power output cable.

Figure 4-20 Connecting the power output cable

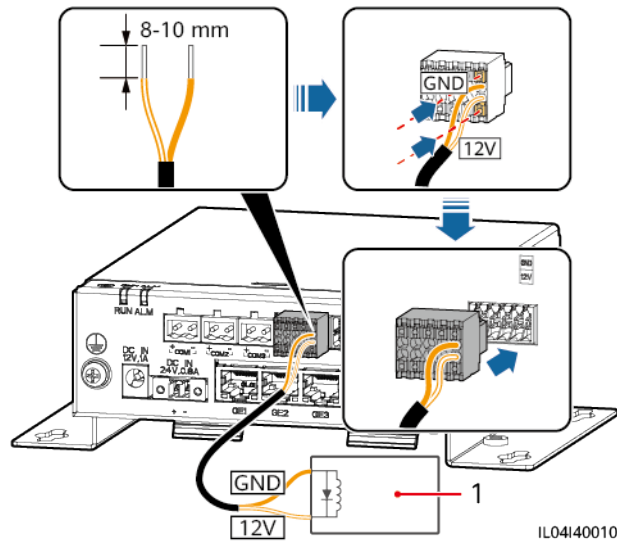

(1) Intermediate relay

----End

4.2.8 Connecting the AI Signal Cable

Context

The SmartModule can receive AI signals from EMIs over AI ports. It is recommended that the signal transmission distance be less than or equal to 10 m.

Procedure

Step 1 Connect the AI signal cable.

Figure 4-21 Connecting the AI signal cable

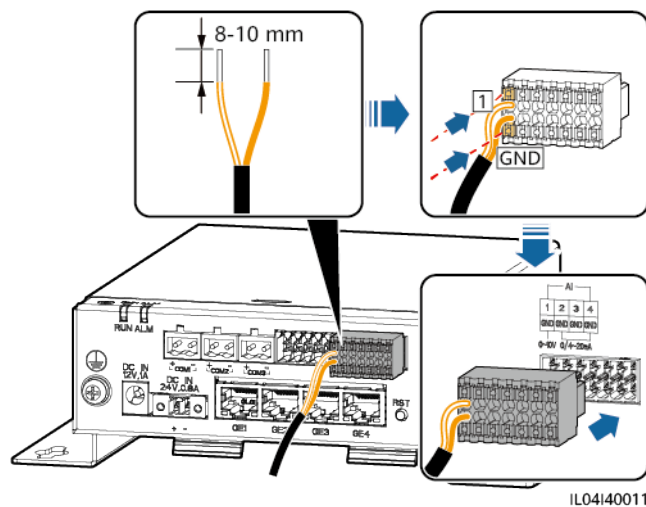

Port		Silk Screen	Description
AI	AI1	1	Supports 0–10 V input voltage.
		GND	
	AI2	2	Support 0–20 mA or 4–20 mA input current.
		GND	
	AI3	3	
		GND	
	AI4	4	
		GND	

 **NOTE**

AI ports 1, 2, 3, and 4 are for AI+ signals, and the GND port is for AI- signals.

----End

4.2.9 Connecting the PT Signal Cable

Context

- The SmartModule provides two PT ports, which can be used to connect to three-wire or two-wire PT100/PT1000 temperature sensors.
- When a PT port needs to be connected to a two-wire PT100/PT1000, use a short-circuit cable to short-circuit **GND** and – of the port.

Procedure

Step 1 Connect the PT signal cable.

Figure 4-22 Connection to a three-wire PT100/PT1000

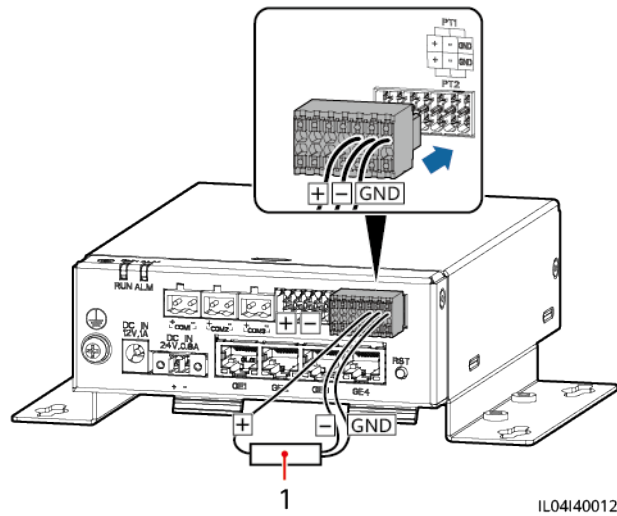

(1) PT100/PT1000 temperature sensor

Figure 4-23 Connection to a two-wire PT100/PT1000

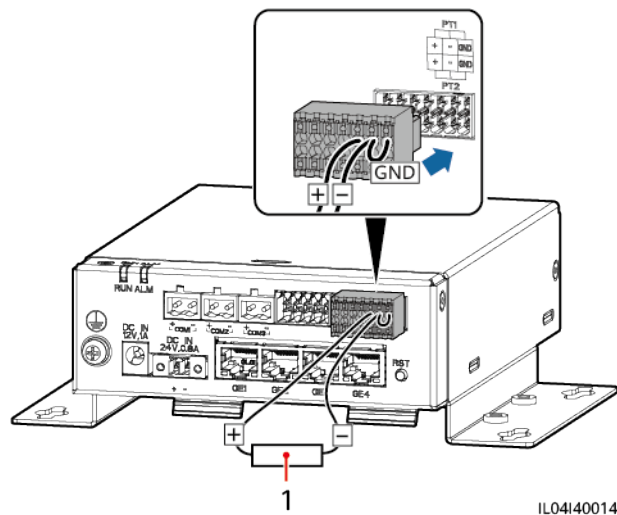

(1) PT100/PT1000 temperature sensor

----End

4.2.10 Connecting the 24 V Power Input Cable

Context

The 24 V power input cable needs to be connected in the following scenarios:

- Scenario 1: The 24 V DC power supply is used.
- Scenario 2: The SmartModule connects to the power supply through the 12 V power input port, and the 24 V power input cable functions as the 12 V power output port to supply power to a device.

Procedure

Step 1 Connect the power input cable.

Figure 4-24 Connecting the power input cable

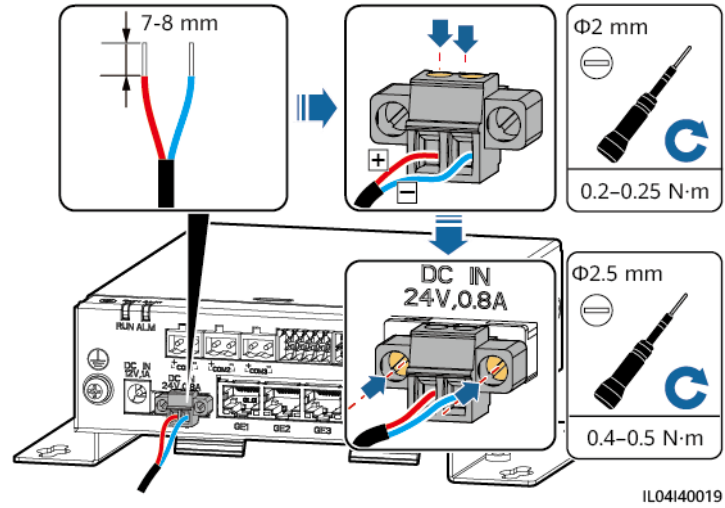

----End

5 System Operation

5.1 Check Before Power-on

No.	Check That
1	The SmartLogger and SmartModule are installed correctly and securely.
2	All cables are connected securely.
3	Routing for the power cables and signal cables meets the requirements for routing strong-current and weak-current cables and complies with the cable routing plan.
4	Cables are bound neatly, and cable ties are secured evenly and properly in the same direction.
5	There are no sundries such as unnecessary adhesive tape or cable ties on cables.

5.2 Powering On the System

Step 1 Connect the power supply.

- **Method 1:** When a power adapter is used, connect the power adapter cable and turn on the switch on the AC socket side.

 **NOTE**

- The rated input voltage of the power adapter is 100–240 V AC, and the rated input frequency is 50/60 Hz.
- Select an AC socket that matches the power adapter.

Figure 5-1 Power supply through the power adapter

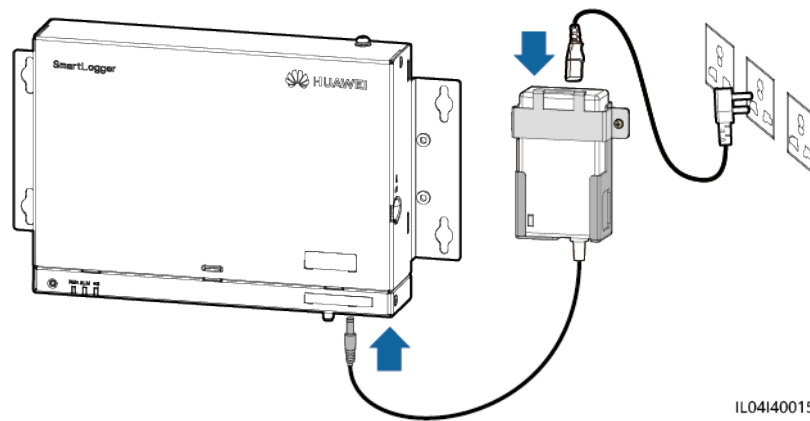

IL04I40015

- **Method 2:** When a DC power supply is used, check that the cable between the DC power supply and the SmartLogger as well as the SmartModule is connected properly, and turn on the upstream power switch of the DC power supply.

Step 2 When MBUS is used for communication, turn on all the upstream switches of the MBUS port.

----End

6 WebUI Operations

6.1 Introduction to WebUI

NOTICE

- The web software versions corresponding to the WebUI screenshots in this document are V300R001C00SPC050 and V300R023C00. The screenshots are for reference only.
 - The parameter names, value ranges, and default values are subject to change. The actual display may vary.
 - Delivering a reset, shutdown, or upgrade command to the inverter and Smart PCS may cause power grid connection failure, which affects the energy yield.
 - Only professionals are allowed to set the grid parameters, protection parameters, feature parameters, and power adjustment parameters of the inverter and Smart PCS. If the power grid parameters, protection parameters, and feature parameters are incorrectly set, the inverter and Smart PCS may fail to connect to the power grid. If the power adjustment parameters are incorrectly set, the inverter and Smart PCS may fail to connect to the power grid as required. In these cases, the energy yield will be affected.
 - Only professionals are allowed to set the power grid scheduling parameters of the SmartLogger. Incorrect settings may cause the plant to fail to connect to the power grid as required, which affects the energy yield.
-

6.1.1 WebUI Layout

Figure 6-1 WebUI layout

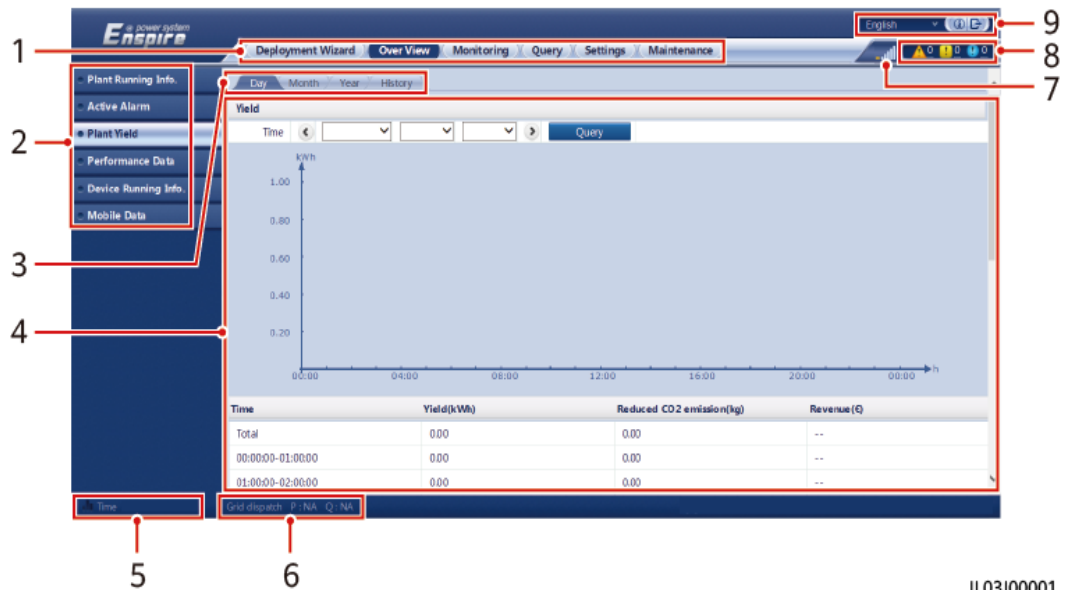

IL03J00001

No.	Function	Description
1	First-level menu	Choose the corresponding first-level menu before you perform any operation over the WebUI.
2	Second-level menu	Under the first-level menu, choose the device to be queried or the parameter to be set under the second-level menu.
3	Third-level menu	<ul style="list-style-type: none"> After choosing a second-level menu, choose a third-level menu to access the query or setting page. There are no third-level menus under certain second-level menus.
4	Details page	Displays details of the queried information or parameter setting.
5	System time	Displays the current system time.
6	Power grid scheduling	Displays the current power grid scheduling mode and scheduling value of the system.
7	Icon for SIM card signal strength	Displays the signal strength of the SIM card.
8	Alarm icon	Displays the severities and number of active system alarms. You can click a number to access the alarm page.
9	Display language	Selects the display language or chooses to log out.

Figure 6-2 Plant running information (without battery or power meter)



No.	Parameter	Description
1	Active power	Total active power of inverters
2	Energy yield of current day	Total energy yield of inverters on the current day
3	Total energy yield	Total energy yield of inverters
4	Reduced CO2 emission	(Total energy yield – Total power supply from grid) x CO ₂ emission reduction coefficient. If the result is negative, the value is zero.
5	Revenue	(Total energy yield – Total power supply from grid) x Revenue coefficient. If the result is negative, the value is zero.

Figure 6-3 Plant running information (with power meter but without battery)



No.	Parameter	Description
1	Active power	Total active power of inverters
2	Reactive power	Vector sum of the reactive power of inverters: Positive value indicates that power is transmitted to the grid and negative value indicates that power is transmitted from the grid.
3	Load power	Vector sum of the active power and grid-tied active power
4	Grid-tied active power	Active power of the feed-in meter: Positive value indicates purchasing electricity and negative value indicates selling electricity.
5	Grid-tied reactive power	Reactive power of the feed-in meter: Positive value indicates that power is transmitted from the grid and negative value indicates that power is transmitted to the power grid.
6	Energy yield of current day	Total energy yield of inverters on the current day
7	Daily consumption	Energy yield of current day + Daily supply from grid – Daily feed-in to grid – Today's power supply from grid
8	Daily feed-in to grid	Current total negative active energy of the feed-in meter – Total negative active energy at 00:00 on the current day
9	Daily supply from grid	Current total positive active energy of the feed-in meter – Total positive active energy at 00:00 on the current day
10	Total energy yield	Total energy yield of inverters

Figure 6-4 Plant running information (with battery but without power meter)

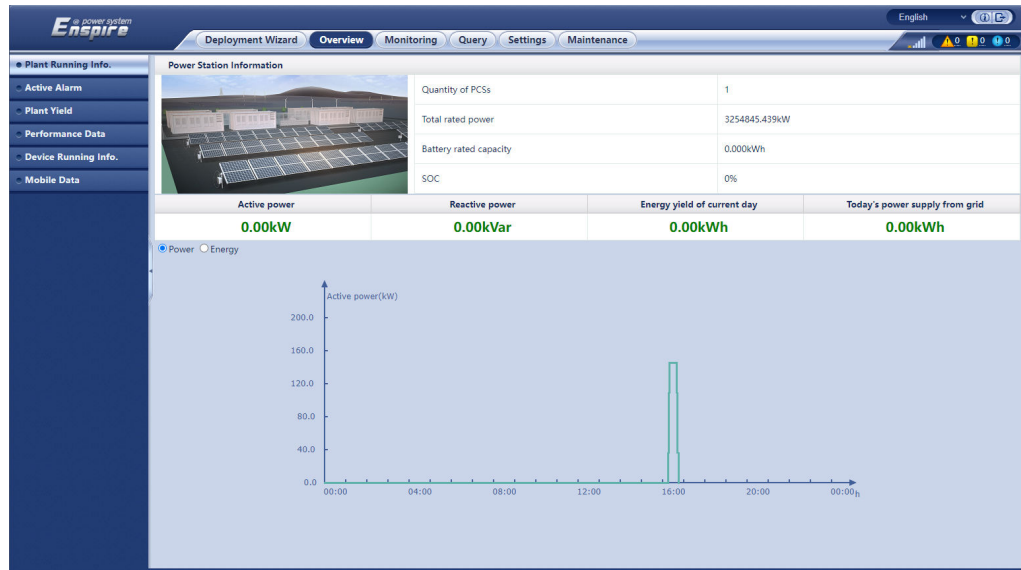















No.	Parameter	Description
1	Active power	Vector sum of the active power of inverters and Smart PCSs: Positive value indicates that energy is generated through the inverter and negative value indicates that energy is stored through the rectifier.
2	Reactive power	Vector sum of the reactive power of inverters and Smart PCSs: Positive value indicates that power is transmitted to the grid and negative value indicates that power is transmitted from the grid.
3	Energy yield of current day	Total energy yield of inverters and Smart PCSs of the current day
4	Today's power supply from grid	Total power supplied from the grid to inverters and Smart PCSs of the current day



Figure 6-5 Plant running information (with power meter and battery)



No.	Parameter	Description
1	Active power	Vector sum of the active power of inverters and Smart PCSs: Positive value indicates that energy is generated through the inverter and negative value indicates that energy is stored through the rectifier.
2	Reactive power	Vector sum of the reactive power of inverters and Smart PCSs: Positive value indicates that power is transmitted to the grid and negative value indicates that power is transmitted from the grid.
3	Load power	Vector sum of the active power and grid-tied active power
4	Grid-tied active power	Active power of the feed-in meter: Positive value indicates purchasing electricity and negative value indicates selling electricity.
5	Grid-tied reactive power	Reactive power of the feed-in meter: Positive value indicates that power is transmitted from the grid and negative value indicates that power is transmitted to the power grid.
6	Energy yield of the current day	Total energy yield of the inverter and Smart PCS on a day
7	Today's power supply from grid	Total power supplied from the grid to the inverter and Smart PCS on a day
8	Daily consumption	Energy yield of current day + Daily supply from grid - Daily feed-in to grid - Today's power supply from grid
9	Daily supply from grid	Current total positive active energy of the feed-in meter - Total positive active energy at 00:00 on the current day

6.1.2 Icon Description

Icon	Description	Icon	Description
	Click the About icon to query the WebUI version information.		Click the Drop-down icon to select a parameter or time.
	Click the Exit icon to log out.		Alarms are classified into major, minor, and warning ones. Click the Alarm icon to query an alarm.
	Click the Increase/Decrease icon to adjust time.		Click the Start icon to start the device.
	The Select icon indicates that a parameter is selected.		Click the Stop icon to shut down the device.
	The Select icon indicates that a parameter is not selected. Click the icon to select a parameter.		Click the Reset icon to reset the device.
	Hide icon and Display icon.		<ul style="list-style-type: none"> The inverter and Smart PCS are in Running state. The device such as the EMI, power meter, slave SmartLogger, or MBUS is in Online state. The PID is in Running state.
	The device is in Disconnection state. If a device is in Disconnection state, its parameters cannot be set.		The inverter and Smart PCS are in Loading state.

Icon	Description	Icon	Description
	<ul style="list-style-type: none"> The inverter and Smart PCS are in abnormal grid-tied power generation state, such as Initializing, Power-off, and Idle. The PID device is in Power-off, Idle or other state in which it is not running properly. 		Ascending order or descending order icon. Click the icon to sort the items in ascending or descending order for the corresponding column.
	Icons during deployment, including Cable connection alarm, Add Devices, Remove Devices, Modify Device Info, and Topology view .	-	-

6.1.3 WebUI Menus

Table 6-1 WebUI menus

Main Menu	Second-Level Menu	Third-Level Menu	Function
Deployment Wizard	-	-	Supports the deployment wizard function. You can set deployment parameters, connect devices, and connect to the management system according to the wizard.
Overview	Plant Running Info.	-	Queries PV plant information.
	Active Alarm	-	Queries active alarms.

Main Menu	Second-Level Menu	Third-Level Menu	Function
	Yield	-	Queries the energy generated, consumed, purchased, and sold. <ul style="list-style-type: none"> • Daily data (at hourly granularity) can be stored for 30 days. • Monthly data (at daily granularity) can be stored for one year. • Yearly data (at monthly granularity) can be stored for 10 years. • Historical data (at yearly granularity) can be stored for 25 years.
	Performance Data	-	Queries or exports performance data.
	Device Running Info.	-	Queries or exports device running information.
	Mobile Data	-	Queries mobile network data.
Monitoring	SmartLogger3000	Running Info.	Queries the running information.
		Active Alarm	Queries active alarms.
		Module(M1)	Queries the expansion module.
		About	Queries the version and communication information of the master SmartLogger.
	SmartLogger	About	Queries the version and communication information of the slave SmartLogger.
	Inverter NOTE SUN2000 is displayed for V300R001C00.	Running Info.	Queries the running information.
		Active Alarm	Queries active alarms.
		Performance Data	Queries or exports performance data.
		Yield	Queries the energy yield.
		Running Param.	Sets running parameters.
		Tracking System	Sets tracking system parameters.
		Battery	Queries or sets battery parameters.
		Characteristic Curve	Sets the characteristic curve.

Main Menu	Second-Level Menu	Third-Level Menu	Function
		About	Queries the version and communication information.
	PCS	Running Info.	Queries the running information.
		Active Alarm	Queries active alarms.
		Performance Data	Queries or exports performance data.
		Yield	Queries the energy yield.
		Running Param.	Sets running parameters.
		Characteristic Curve	Sets the characteristic curve.
		About	Queries the version information.
	CMU	Running Info.	Queries the running information.
		Active Alarm	Queries active alarms.
		Performance Data	Queries or exports performance data.
		Yield	Queries the energy yield.
		Running Param.	Sets running parameters.
		About	Queries the version information.
	ESU	Running Info.	Queries the running information.
		Active Alarm	Queries active alarms.
		Running Param.	Sets running parameters.
		About	Queries the version information.
	ESC	Running Info.	Queries the running information.
		Performance Data	Queries or exports performance data.
		Running Param.	Sets running parameters.
		About	Queries the version information.

Main Menu	Second-Level Menu	Third-Level Menu	Function
	ESR	Running Info.	Queries the running information.
		Performance Data	Queries or exports performance data.
		Yield	Queries the energy yield.
		Running Param.	Sets running parameters.
		Optimizer status	Queries the working status of the battery pack optimizer.
	ESM	Running Info.	Queries the running information.
		Running Param.	Sets running parameters.
		About	Queries the version information.
	HVAC	Running Info.	Queries the running information.
		Running Param.	Sets running parameters.
		About	Queries the version information.
	TCU	Running Info.	Queries the running information.
		Active Alarm	Queries active alarms.
		About	Queries the version information.
	MBUS	Running Info.	Queries the running information.
		STA List	<ul style="list-style-type: none"> • Sets or synchronizes the baud rates of MBUS communication devices. • Exports the STA list.
		Networking Settings	<ul style="list-style-type: none"> • Sets running parameters. • Manages the SN list.
		About	Queries the version and communication information.
	EMI	Running Info.	Queries the running information.
		Performance Data	Queries or exports performance data.
Running Param.		Sets running parameters.	
About		Queries communication information.	

Main Menu	Second-Level Menu	Third-Level Menu	Function
	Meter NOTE Power Meter is displayed for V300R001C00.	Running Info.	Queries the running information.
		Performance Data	Queries or exports performance data.
		Running Param.	Sets the running parameters of the DL/T645 power meter.
		Active Alarm	Queries active alarms.
		About	Queries communication information.
	PID	Running Info.	Queries the running information.
		Active Alarm	Queries active alarms.
		Performance Data	Queries or exports performance data.
		Running Param.	Sets running parameters.
		About	Queries the version and communication information.
	STS	Teleindication	Queries teleindication parameters.
		Telemetry	Queries telemetry parameters.
		Telecontrol	Sets telecontrol parameters.
		Performance Data	Queries or exports performance data.
		Running Param.	Sets running parameters.
		About	Queries communication information.
	Custom Device, IEC103 Device, and IEC104 Device	Running Info.	Queries the running information.
		Teleindication	Queries teleindication parameters.
		Telemetry	Queries telemetry parameters.
		Telecontrol	Sets telecontrol parameters.
Teleadjust		Sets teleadjust parameters.	
Query	Alarm History	-	Queries historical alarms.
	Operation Log	-	Queries operation logs.
	Export Data	-	Exports historical alarms, energy yield, operation logs, and power grid scheduling data.

Main Menu	Second-Level Menu	Third-Level Menu	Function
	Security Events	-	Queries security events.
Settings	User Param.	Date&Time	Sets the date and time.
		Plant	Sets plant information.
		Revenue	Sets the revenue parameters.
		Save Period	Sets the save period of performance data.
	Comm. Param.	Wireless Network	<ul style="list-style-type: none"> • Sets parameters for the built-in WLAN. • Sets mobile data (4G/3G/2G) parameters.
		Wired Network	Sets wired network parameters.
		RS485	Sets RS485 parameters.
		Management System	<ul style="list-style-type: none"> • Sets management system parameters. • Uploads a security certificate.
		Modbus TCP	Sets Modbus TCP parameters.
		IEC103	Sets IEC103 parameters.
		IEC104	Sets IEC104 parameters.
		FTP	Sets FTP parameters.
		Email	Sets email parameters.
		ESGCC	Sets the parameters related to the ESGCC.
		GOOSE	Sets GOOSE parameters.
		Power Adjustment	Active Power Control
	Reactive Power Control		Sets parameters for reactive power control.
	Export Limitation		Provides a wizard for export limitation. You can set parameters by following the wizard.
	Smart Reactive Power Compensation		Provides a wizard for smart reactive power compensation. You can set parameters by following the wizard.

Main Menu	Second-Level Menu	Third-Level Menu	Function
		DRM	Sets DRM parameters.
	EMS Control	-	Sets the working mode of battery control.
	Battery Control	Battery Control	Sets the working mode of battery control.
		Capacity Limit	Sets the working mode of capacity limit.
	Remote Shutdown	Dry Contact Remote Shutdown	Sets parameters for remote shutdown over dry contacts.
		NS Protection Remote Shutdown	Sets remote shutdown parameters for NS protection.
	DI	DI Port Configuration	Configures the DI port function.
		Startup Delay	Set the startup delay time.
	Alarm Output	-	Sets the mapping between inverter alarms and DO ports.
	Smart Tracking Algorithm	-	Sets the parameters related to the smart tracking algorithm.

Main Menu	Second-Level Menu	Third-Level Menu	Function
	Other Parameters	-	<ul style="list-style-type: none"> ● Enables or disables RS485 upgrade rate adaptation. ● Enables or disables data forwarding for unconnected devices. ● Sets the IEC104 data push period. ● Enables or disables AI1 SPD alarm detection. ● Enables or disables STS overtemperature protection. ● Sets the reset control port of the external router. ● Enables or disables mobile network sharing. ● Sets a third-party server. ● Sets target network. ● Enables or disables SSH. ● Sets collection interval of the built-in MBUS. ● Enables or disables no response from disconnected devices. ● Enables or disables local maintenance through WAN port. ● Sets battery log printout interval. ● Enables or disables load tracking. ● Enables or disables battery export limitation. ● Sets maximum grid power during battery discharge. ● Sets adjustment deadband. ● Enables or disables DER-AVM access.
Maintenance	Firmware Upgrade	-	Upgrades the firmware of the SmartLogger, inverter, MBUS, or PID.
	Product Information	-	Queries product information.

Main Menu	Second-Level Menu	Third-Level Menu	Function
	Security Settings	-	<ul style="list-style-type: none"> Changes the user password. Sets the automatic logout time. Uploads a WebUI security certificate. Updates the key. Sets the certificate alarm time. Uploads a SmartModule security certificate. Enables or disables communication using an expired SmartModule certificate. Sets web TLS1.0, 1.1. Sets digital signature verification. Enables or disables intrusion detection.
	System Maint.	-	<ul style="list-style-type: none"> Resets the system. Restores factory settings. Clears data. Exports all configuration files. Imports all configuration files. Clears cache.
	Device Log	-	Exports device logs.
	Onsite Test	Inspection	Starts the health check of inverters.
		Spot-check	Starts the spot-check of inverters.
		Alarm Test	Simulates or clears alarms of inverters.
	License Management	-	<ul style="list-style-type: none"> Views the license information. Exports the license application file. Loads or revokes a license.
	User Management	-	Add, modify, or delete a user.
	Device Mgmt.	Connect Device	<ul style="list-style-type: none"> Adds or removes a device. Imports or exports configurations.
		SmartModule	<ul style="list-style-type: none"> Removes the SmartModule. Sets the authentication password.

Main Menu	Second-Level Menu	Third-Level Menu	Function
		Device List	<ul style="list-style-type: none"> Modifies device information. Imports or exports device information.
		Export Param.	Exports device parameters.
		Clear Alarm	Clears device alarms.
		Data Re-collection	Re-collects historical performance data and energy yield of devices.
		Adjust total energy yield	Adjusts the total energy yield.
		Force Start	Sends a force start command to all devices in the array.

 **NOTE**

The third-level menu varies with the device model and grid code. The displayed menu may vary.

6.2 Device Commissioning

Prerequisites

- Device and cable installation has been checked according to the specifications and requirements of PV and energy storage plants.
- Devices in the PV and energy storage plants and SmartLogger are powered on.
- You have obtained the IP address of the SmartLogger as well as the user name and password used for logging in to the WebUI.

Context

After installing or replacing a device or SmartLogger, you need to set device parameters and add the device.

6.2.1 Preparations and WebUI Login

Prerequisites

- The operating system of Windows 7 or later is supported.
- Browser: Chrome 52, Firefox 58, or Internet Explorer 9, or a later version is recommended.
- It is recommended that a maximum of two users log in to the WebUI at the same time.

Procedure

- Step 1** Connect the network cable between the network port of the PC and the WAN or LAN port of the SmartLogger. It is recommended that the PC be connected to the LAN port of the SmartLogger.
- Step 2** Set the IP address for the PC on the same network segment as the SmartLogger IP address.

Connected Port	Item	SmartLogger Default Value	Example PC Setting
LAN port	IP address	192.168.8.10	192.168.8.11
	Subnet mask	255.255.255.0	255.255.255.0
	Default gateway	192.168.8.1	192.168.8.1
WAN port	IP address	192.168.0.10	192.168.0.11
	Subnet mask	255.255.255.0	255.255.255.0
	Default gateway	192.168.0.1	192.168.0.1

NOTE

- When the IP address of the WAN port is in the network segment from 192.168.8.1 to 192.168.8.255, set the default gateway to 192.168.8.1 and the IP address of the LAN port to 192.168.3.10. If the connected port is a LAN port, you need to adjust the network configuration of the PC.
- It is recommended that the PC be connected to the LAN port of the SmartLogger or the GE port of the SmartModule. When the PC is connected to the GE port of the SmartModule, adjust the network configuration of the PC to the configuration mode when the PC is connected to the LAN port of the SmartLogger.

- Step 3** Set LAN parameters.

NOTICE

- If the SmartLogger is connected to a LAN and a proxy server has been configured, you need to cancel the proxy server configurations.
- If the SmartLogger is connected to the Internet and the PC is connected to the LAN, do not cancel the proxy server configurations.

-
1. Open Internet Explorer.
 2. Choose **Tools > Internet Options**.
 3. Click the **Connections** tab and then click **LAN settings**.
 4. Clear **Use a proxy server for your LAN**.

Figure 6-6 LAN settings

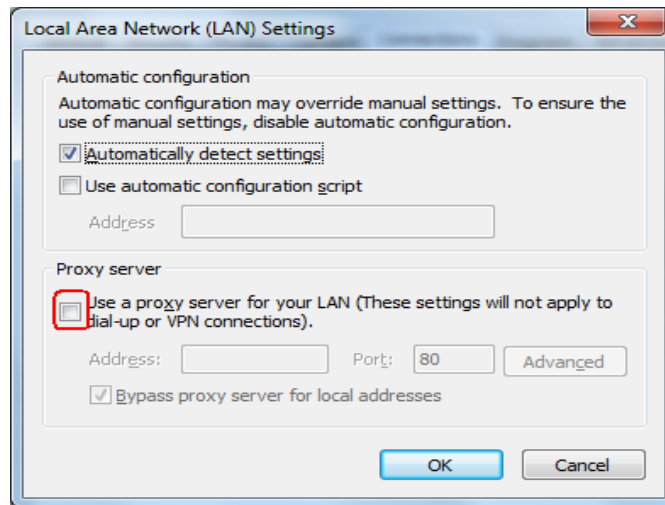

5. Click **OK**.

Step 4 Log in to the SmartLogger WebUI.

1. In the address box of a browser, enter **https://XX.XX.XX.XX** (XX.XX.XX.XX is the IP address of the SmartLogger) and press **Enter**. The login page is displayed.

If you log in to the WebUI for the first time, a security risk warning is displayed. Click **Continue to this website** to log in to the WebUI.

NOTE

- It is recommended that users use their own certificates. If the certificate is not replaced, the security risk warning will be displayed during each login.
- After logging in to the WebUI, you can import a certificate under **Maintenance > Security Settings > Network Security Certificate**.
- The imported security certificate needs to be bound to the SmartLogger IP address. Otherwise, the security risk warning will still be displayed during login.
- If an error message "ERR_INSUFFICIENT_RESOURCES" is displayed for the browser during login, the browser resources are insufficient. Clear the cache and restart the browser.
- If an error message "ERR_CONNECTION_TIMED_OUT" is displayed for the browser during login, perform the following troubleshooting operations:
 - Check whether the browser proxy is abnormal. If yes, set the browser proxy according to step 3.
 - Check whether the IP address of another device conflicts with that of the SmartLogger. If yes, assign a new IP address.

Figure 6-7 Security risk warning

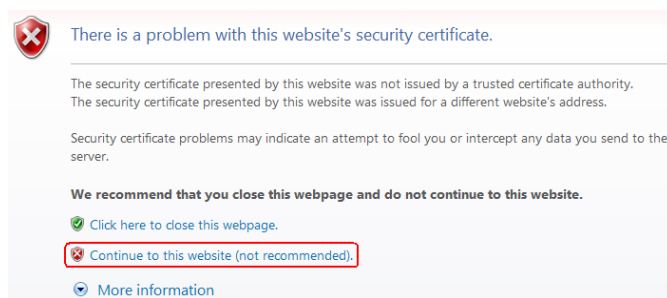

2. Select a desired language.
3. Select **User Name** and enter **Password** according to the following table, and then click **Log In**.

If...	Then...
On the login page, User Name is admin by default.	<ol style="list-style-type: none"> 1. Enter the initial password Changeme in Password and click Log In. 2. Change the initial password as prompted and use the admin user name and new password to log in again.
On the login page, User Name is empty by default.	Select installer in User Name , set the login password as prompted, and click Log In .

 **NOTE**

- Update the SmartLogger software as required.
 - To ensure account security, protect the password by changing it periodically, and keep it secure. Your password might be stolen or cracked if it is left unchanged for extended periods. If you lose the password, the device must be restored to its factory settings. In these cases, the Company shall not be liable for any loss caused to the plant.
 - You will be locked out for 10 minutes after five consecutive failed password attempts in 5 minutes.
 - A dialog box with recent login information is displayed after login. Click **OK**.
 - If the password of a non-administrator account is lost, you must reset the password using an administrator account. The administrator resets the password and enters the initial password. The non-administrator user logs in to the system using the initial password provided by the administrator. After the login, the user is forced to change the password.
 - If the password of an administrator account is lost, hold down the RST button on the SmartLogger for 10–20s to enter the safe mode. After the SmartLogger enters the safe mode, the device parameter settings are retained. Personal privacy and sensitive data, including login passwords and email addresses, will be deleted. SmartLogger V300R023C00 and later versions support this function.
4. Choose **Monitoring > Logger(Local) > About** to view the SmartLogger software version and check whether software upgrade is needed.

5. (Optional) To upgrade the SmartLogger software version, contact the Company's engineers to obtain the upgrade package and guide and complete the upgrade accordingly.

 **NOTE**

- After the software upgrade is complete, the SmartLogger automatically restarts. Log in to the SmartLogger WebUI again 3 minutes later.
- If the SmartLogger is upgraded from V300R001C00 to V800R021C00, the original administrator **admin** becomes an advanced user, and the login password remains unchanged. If administrator rights are required, log in to the SmartLogger as **installer**. The password is the same as that for logging in to the mobile app. If the SmartLogger is upgraded from V800R021C00 to V300R023C00, the login passwords of the advanced user **admin** and administrator **installer** remain unchanged.
- If the SmartLogger is upgraded from V300R001C00 to V300R023C00, the original administrator **admin** becomes an advanced user, and the login password remains unchanged. If administrator rights are required, log in to the SmartLogger as **installer** and set the login password as prompted.

----End

Follow-up Procedure

If any page is blank or a menu cannot be accessed after you log in to the WebUI, clear the cache, refresh the page, or log in again.

6.2.2 Commissioning Using Deployment Wizard (V300R001C00)

Context

The deployment wizard allows you to set basic SmartLogger parameters, connect Huawei devices, power meters, and EMIs, configure Huawei NMS and third-party NMS, and implement interworking with third-party devices.

After the SmartModule communicates with the SmartLogger properly, the SmartLogger automatically identifies the SmartModule. The device name of the SmartModule is **Module(M1)**, and the corresponding port is **M1. port**.

Procedure

- Step 1** Log in as user **admin** to access the deployment wizard page.
- Step 2** Set parameters as prompted. For details, click **Help** on the page.

 **NOTE**

During parameter setting, click **Previous**, **Next**, or **Skip** as required.

Figure 6-8 Deployment wizard

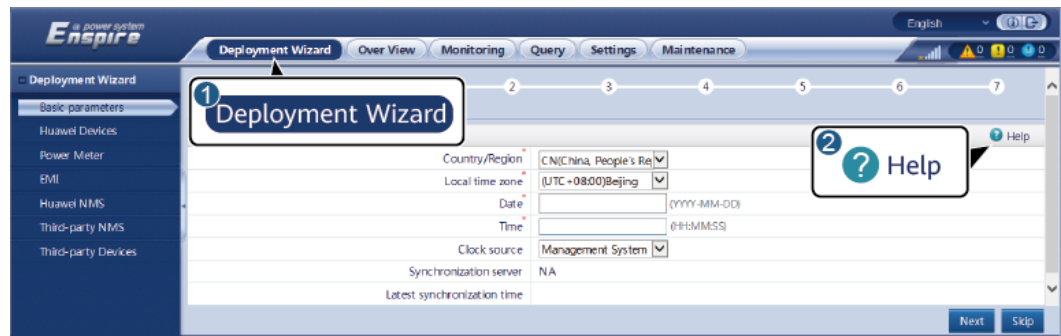

IL03J00003

Step 3 After setting parameters, click **Finish**.

----End

6.2.3 Commissioning Using Deployment Wizard (V800R021C10)

Context

The deployment wizard allows you to set basic SmartLogger parameters, connect Huawei devices, power meters, and EMIs, configure Smart PCS, Huawei NMS, and third-party NMS, and implement interworking with third-party devices.

After the SmartModule communicates with the SmartLogger properly, the SmartLogger automatically identifies the SmartModule. The device name of the SmartModule is **Module(M1)**, and the corresponding port is **M1. port**.

Procedure

Step 1 Log in to the WebUI and access the deployment wizard page.

Step 2 Set corresponding parameters as prompted. For details, see **Help** on the page.

NOTE

During parameter setting, click **Previous**, **Next**, or **Skip** as required.

1. Set basic parameters.

Figure 6-9 Setting basic parameters

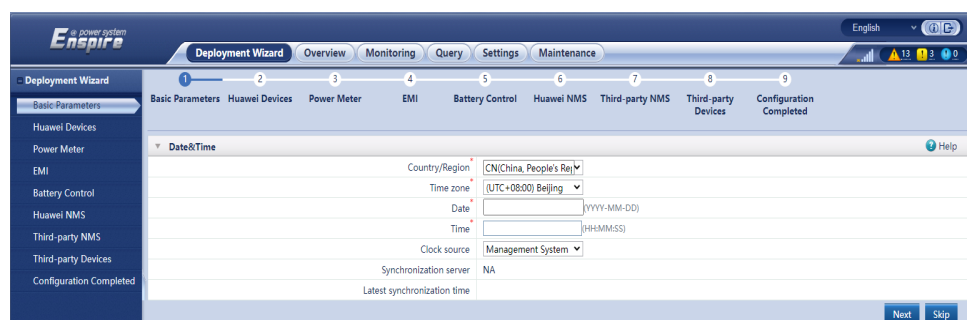

2. After Huawei devices are connected, click **Search for Device** to check the cable connections and allocate addresses.

Figure 6-10 Searching for devices

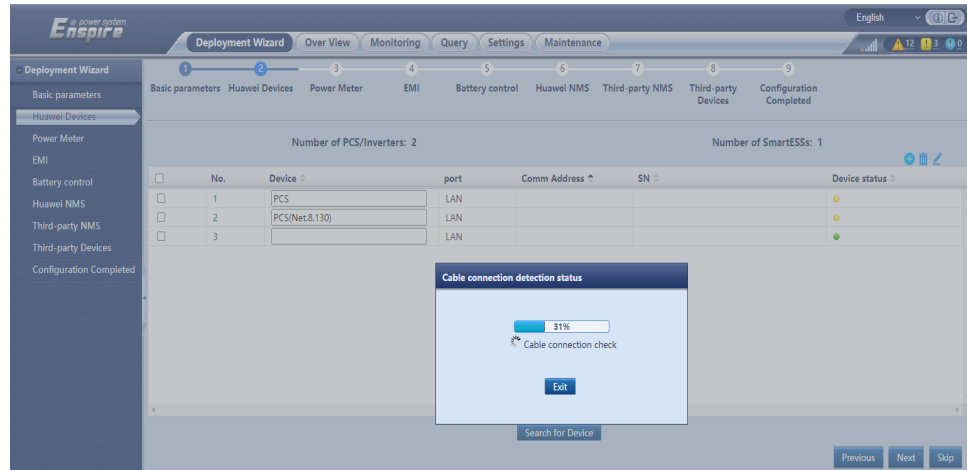

NOTE



- During the process of **Search for Device**, do not perform upgrade operations (such as upgrading through the app, management system, or WebUI).
 - When you click **Search for Device**, cable connections (DC and AC) will be checked before device search (not applicable to third-party devices), and device addresses will be automatically allocated.
 - After the cable connection check and device search are complete, if a cable connection alarm is generated, you can click the alarm icon  to view the corresponding alarm information.
 - If an alarm is generated when the cable connection check fails, click the alarm icon  to view the alarm cause and handling suggestions. After the fault is rectified, check the cable connection again.
 - After the cable connection check and device search are complete, click  to view the corresponding topology information.
 - After a device is added or deleted, you need to click **Search for Device** again in **Deployment Wizard**. Otherwise, the system topology will not be updated.
3. Connect to power meters.

Figure 6-11 Setting power meter parameters



4. Connect to EMIs.

Figure 6-12 Setting EMI parameters

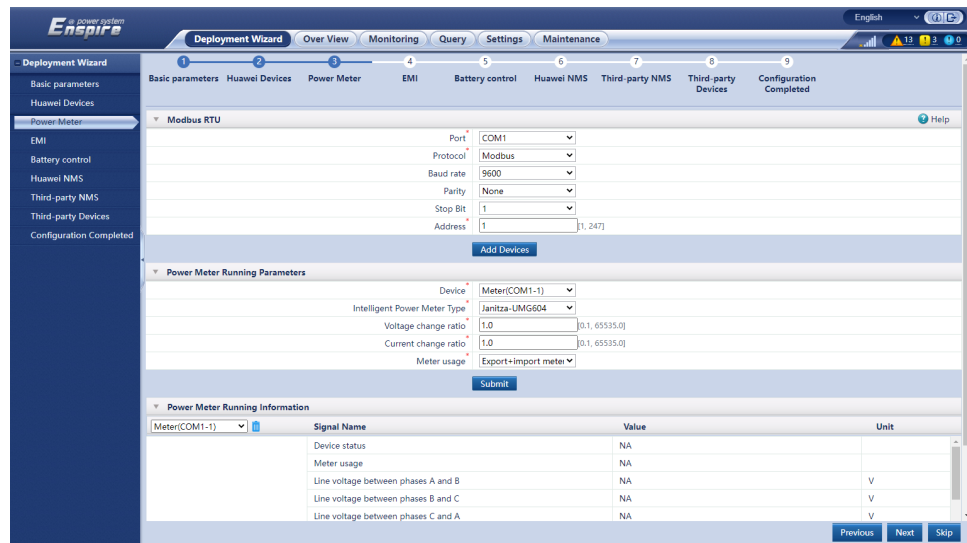
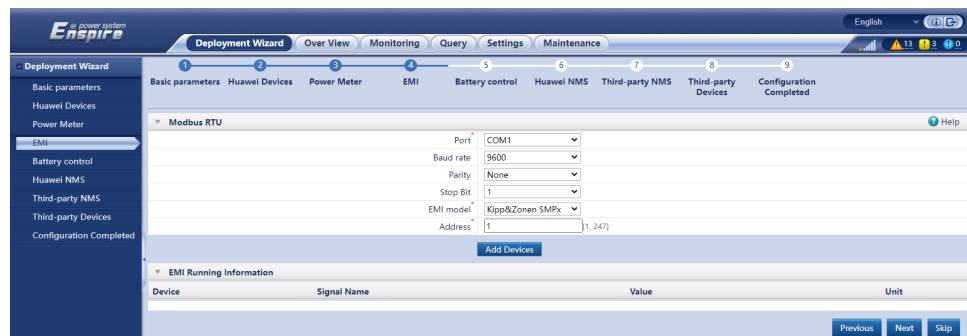

5. Set the battery working mode for battery control.

Figure 6-13 Working modes

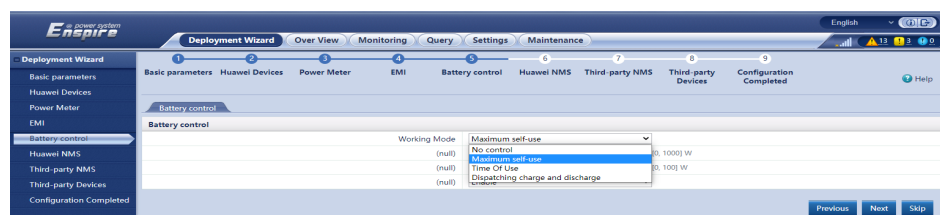

6. Connect to the Huawei NMS.

Figure 6-14 Huawei NMS

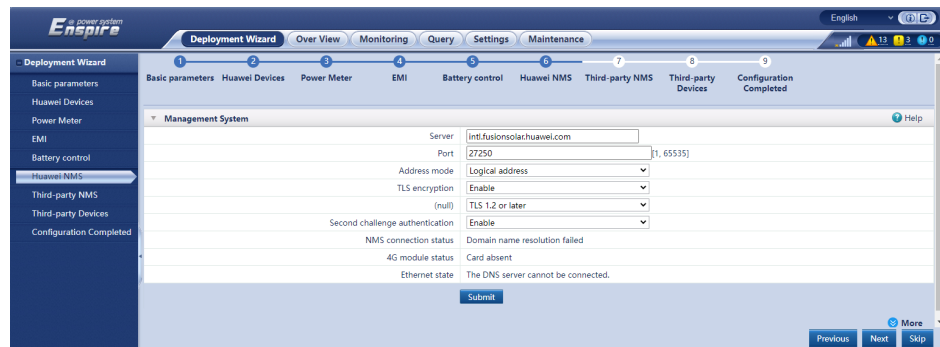

7. Connect to a third-party NMS, select IEC104.

Figure 6-15 Third-party NMS

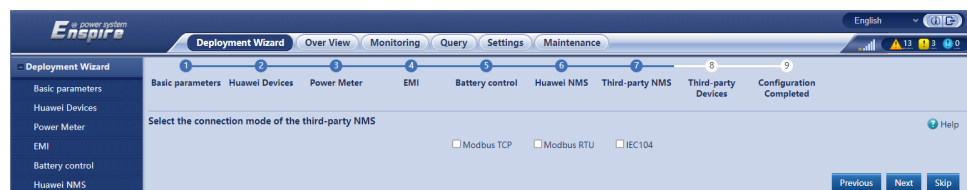

8. Connect to third-party devices.

Figure 6-16 Third-party devices

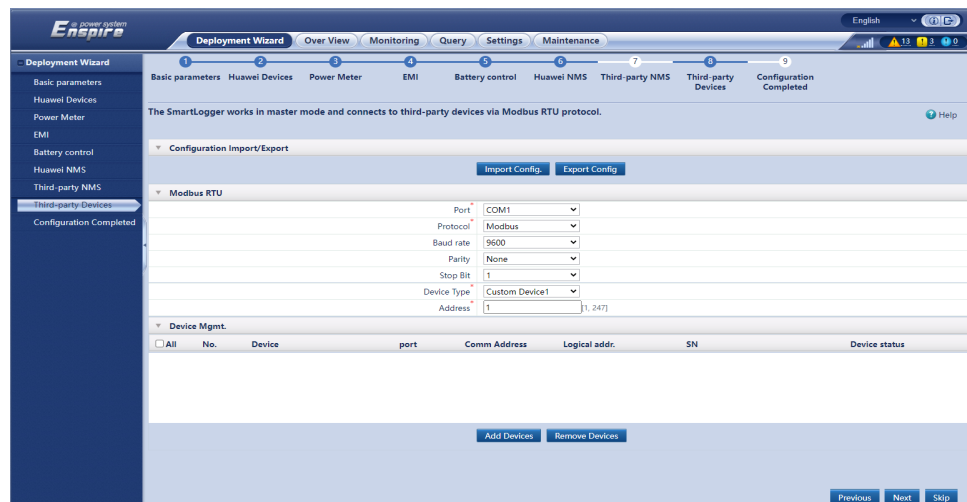

9. Complete the configuration.

Figure 6-17 Completing the configuration

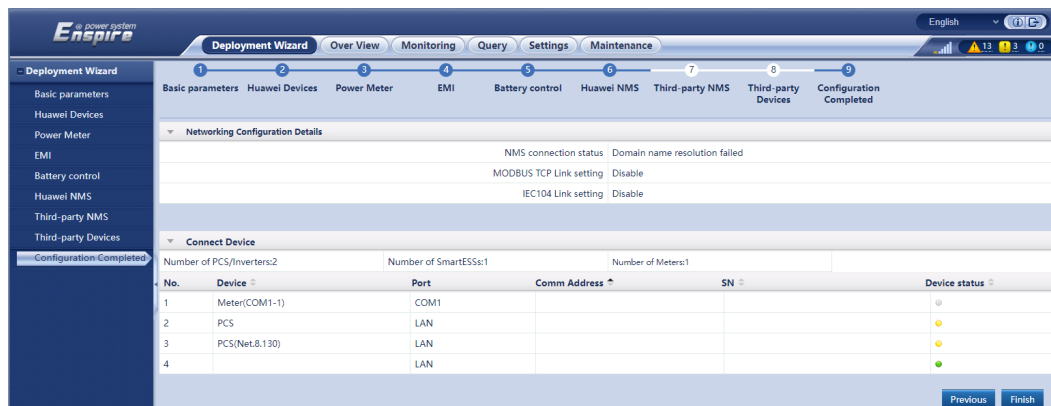

----End

6.2.4 Commissioning Using Deployment Wizard (V300R023C00)

Context

The deployment wizard allows you to set basic SmartLogger parameters, connect Huawei devices, power meters, and EMIs, configure battery control, Huawei NMS, and third-party NMS, and implement interworking with third-party devices. In utility-scale storage-only scenarios and microgrid scenarios, the insulation fault detection function of the Smart PCS is added to improve system safety and reduce costs.

After the SmartModule communicates with the SmartLogger properly, the SmartLogger automatically identifies the SmartModule. The device name of the SmartModule is **Module(M1)**, and the corresponding port is **M1.port**.

Prerequisites

In utility-scale storage-only scenarios and microgrid scenarios, the insulation fault detection function of the Smart PCS supports only the following Huawei devices.

Table 6-2 Device names and models

Device Name	Device Model
Smart String ESS	LUNA2000-2.0MWH-4H1, LUNA2000-2.0MWH-2H1, LUNA2000-2.0MWH-2H0, LUNA2000-2.0MWH-1H1, LUNA2000-2.0MWH-1H0, LUNA2000-1.0MWH-1H1, LUNA2000-200KTL-H1, and LUNA2000-200KTL-H0
STS	STS-6000K-H1, STS-3000K-H1, and JUPITER-9000K-H0
SACU	SmartACU2000D-D-03

Procedure

NOTE

During parameter setting, click **Previous**, **Next**, or **Skip** as required. For details, see **Help** on the page.

Step 1 Click **Deployment Wizard** and set basic parameters.

- Set basic parameters.

Figure 6-18 Setting basic parameters

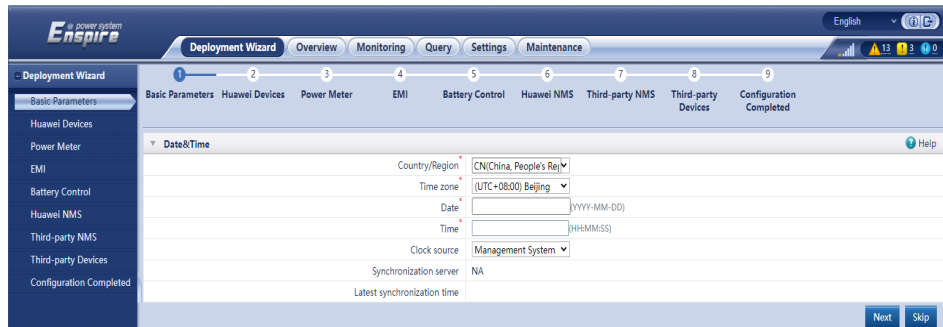

- Select a communication mode based on site requirements.

Step 2 Connect Huawei devices.

- Click **Search for Device** to check the cable connections and allocate addresses.

Figure 6-19 Searching for devices

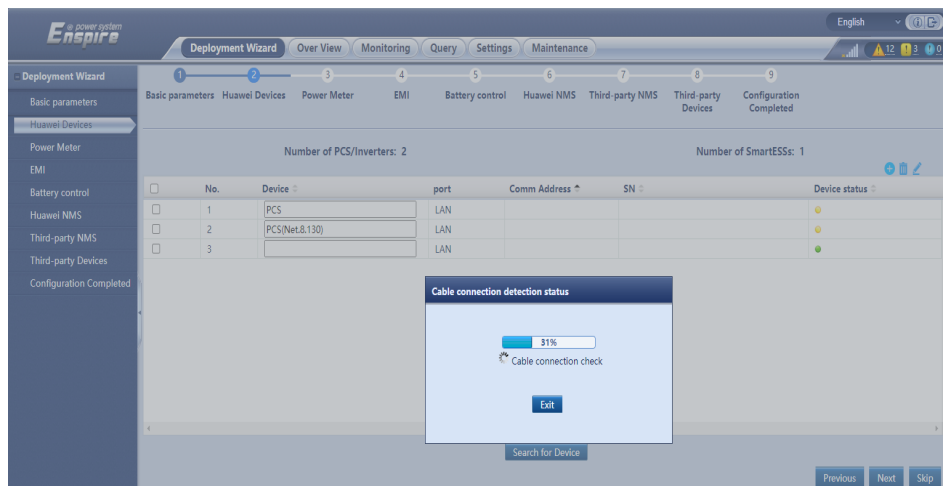

 **NOTE**



- During the process of **Search for Device**, do not perform upgrade operations (such as upgrading through the app, management system, or WebUI).
 - When you click **Search for Device**, cable connections (DC and AC) will be checked before device search (not applicable to third-party devices), and device addresses will be automatically allocated.
 - After the cable connection check and device search are complete, if a cable connection alarm is generated, you can click the alarm icon  to view the corresponding alarm information.
 - If an alarm is generated when the cable connection check fails, click the alarm icon  to view the alarm cause and handling suggestions. After the fault is rectified, check the cable connections again.
 - After the cable connection check and device search are complete, click  to view the corresponding topology information.
 - After a device is added or deleted, you need to click **Search for Device** again in **Deployment Wizard**. Otherwise, the system topology will not be updated.
- Set parameters such as **Microgrid compatibility** and **Grid Code**.

Table 6-3 Parameter settings after device search (for versions earlier than SmartLogger V300R023C10)

Parameter	Description
Running under Grid connection state	Set this parameter only for the PCS, but not for the SUN2000. <ul style="list-style-type: none"> - In the on-grid scenario, set this parameter to On-grid(PQ). - In the off-grid scenario, set this parameter to Off-grid(VSG).
Microgrid compatibility	<ul style="list-style-type: none"> - In the on-grid scenario, set this parameter to Disable. - In the off-grid scenario, set this parameter to Enable.
Grid Code	Set this parameter based on the grid code of the country or region where the devices are used.

NOTICE

For PCSs on the same DC bus, ensure that the settings of **Running under Grid connection state** and **Microgrid compatibility** are the same.

Table 6-4 Parameter settings after device search (SmartLogger V300R023C10 and later versions)

Parameter	Description
Scenario under Arrays Operation Scenario	<ul style="list-style-type: none"> - In the on-grid scenario, set this parameter to On-grid. - In the off-grid scenario, set this parameter to Off-grid. - In the on/off-grid switching scenario, set this parameter to On/Off-grid.
Grid Code	Set this parameter based on the grid code of the country or region where the devices are used.
Working mode under Parameter Configuration	<ul style="list-style-type: none"> - Set this parameter to PQ for the current source mode. - Set this parameter to VSG for the voltage source mode.
Microgrid compatibility under Parameter Configuration	<ul style="list-style-type: none"> - In the on-grid scenario, set this parameter to Disable. - In the off-grid scenario, set this parameter to Enable.
Active Power Baseline (kW) under Parameter Configuration	Set the lower limit of the maximum apparent power, which is also used as the baseline for active power scheduling.
Apparent Power Baseline (kVA) under Parameter Configuration	Set the upper limit of the maximum active power, which is also used as the baseline for reactive power scheduling.
Maximum Overload Active Power (kW) under Parameter Configuration	Set the maximum overload active power for grid forming.
Maximum Overload Apparent Power (kVA) under Parameter Configuration	Set the maximum overload apparent power for grid forming.

NOTICE

For PCSs on the same DC bus, ensure that the settings of **Scenario** under **Arrays Operation Scenario** and **Microgrid compatibility** are the same.

Step 3 Connect to power meters.

Figure 6-20 Setting meter parameters

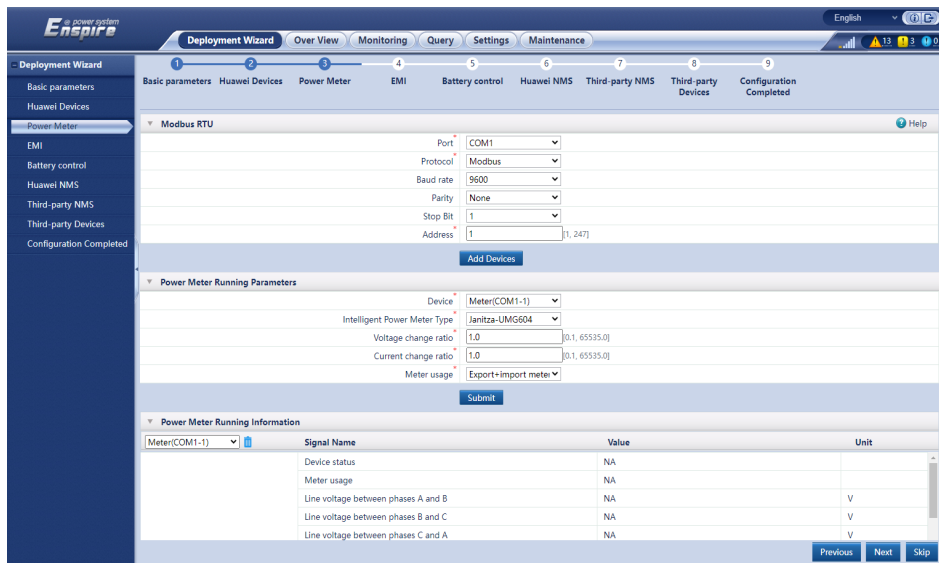

Step 4 Connect to EMIs.

Figure 6-21 Setting EMI parameters

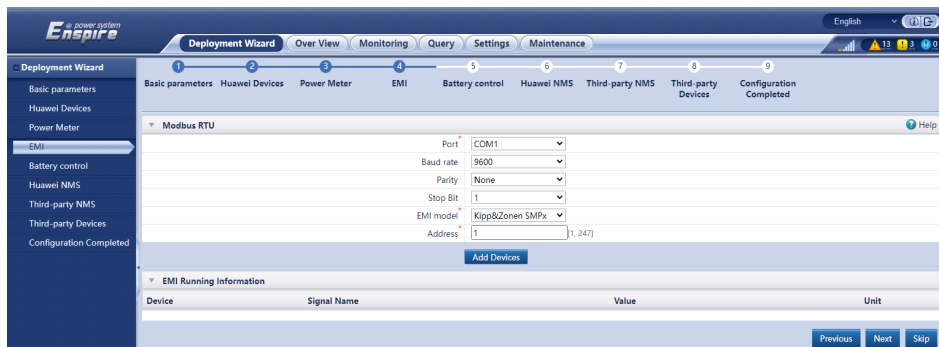

Step 5 Set battery control. This step is required only for the energy storage scenarios.

- Set the battery control working mode.

Figure 6-22 Working mode

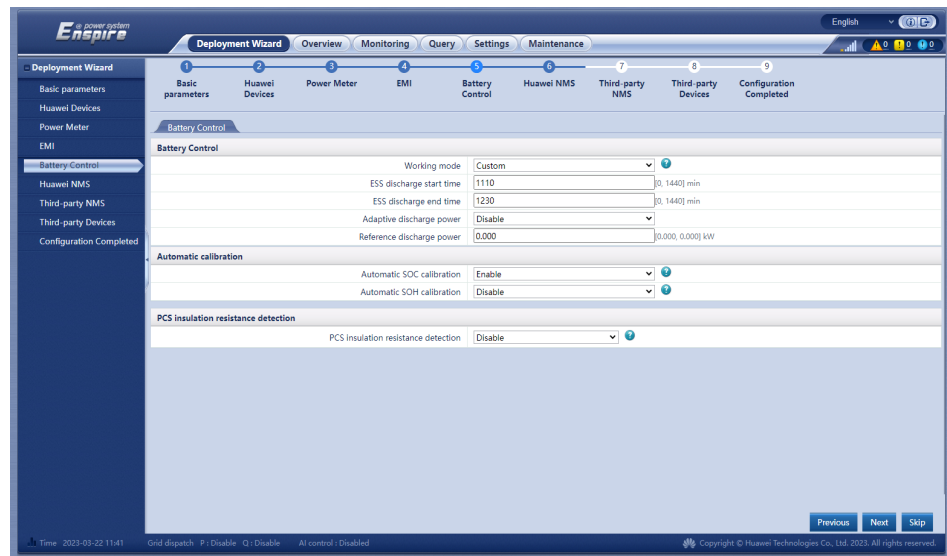

Table 6-5 Battery control working modes

Working Mode	Mode Description
No control	The SmartLogger directly delivers the external scheduling power limit. No other power scheduling control is performed. The power is automatically controlled by the device.
Maximum self-consumption	<ul style="list-style-type: none"> - This mode applies to areas where the electricity price is high, or areas where the FIT subsidy is low or unavailable. The PV+ESS system generates sufficient PV power for loads and uses the surplus PV power to charge the ESS (if the PV power is insufficient for loads, the TOU mode is recommended). - PV power is preferentially supplied to loads, and the surplus power is used to charge the ESS. If the ESS is fully charged or is being charged at full power, the surplus power is fed to the grid. When PV power is insufficient or no PV power can be generated at night, the ESS discharges power to loads. This improves the self-consumption rate and energy self-sufficiency rate, and reduces electricity costs. The grid cannot charge the ESS but can supply power to loads. - The SmartLogger performs ESS scheduling based on the external scheduling power limit and the preceding policies.

Working Mode	Mode Description
<p>Fully fed to grid</p>	<ul style="list-style-type: none"> - This parameter applies only to distributed scenarios. - This mode maximizes the PV energy fed to the grid. When the PV output power in the daytime is greater than the maximum output capacity of the inverter, the surplus PV power is used to charge the ESS. When the PV output power is less than the maximum output capacity of the inverter, the ESS discharges energy to the inverter to maximize the energy fed from the inverter to the grid. The grid cannot charge the ESS. - The SmartLogger directly delivers the external scheduling power limit. <p>NOTE If the CMU is connected, the Fully fed to grid working mode is not displayed.</p>
<p>TOU</p>	<ul style="list-style-type: none"> - It is applicable to the PV+ESS system and ESS-only system where peak to valley electricity prices are different and power meters are available. - You can manually set the charge and discharge time segments. For example, if you set the low electricity price period at night as the charge time, the system charges the batteries at the maximum power during the charge time. If you set the high electricity price period as the discharge time, batteries can discharge only during the discharge time based on the actual load power, reducing electricity costs. - Click Add to set the charge and discharge time segments. A maximum of 14 time segments can be set. During the charge time, the grid can charge the batteries. During the discharge time, the batteries can supply power to the loads. In other time segments, the batteries do not discharge. The PV system and grid supply power to loads, and the PV system can charge the batteries. - In some countries, the grid is not allowed to charge batteries. In such case, this mode cannot be used. - The SmartLogger performs battery scheduling based on the external scheduling power limit and the preceding policies.

Working Mode	Mode Description
<p>TOU (fixed power)^[1]</p>	<ul style="list-style-type: none"> - It is applicable to the PV+ESS system and ESS-only system where peak to valley electricity prices are different and power meters are unavailable. - You can manually set the charge and discharge time segments. For example, if you set the low electricity price period at night as the charge time, the system charges the batteries at the fixed power during the charge time. If you set the high electricity price period as the discharge time, batteries can discharge only during the discharge time at the fixed power, reducing electricity costs. - Click Add to set the charge and discharge time segments. A maximum of 14 time segments can be set. During the charge time, the grid can charge the batteries. During the discharge time, the batteries can supply power to the loads. In other time segments, the batteries do not discharge and are not charged. - In some countries, the grid is not allowed to charge batteries. In such case, this mode cannot be used. - The SmartLogger performs battery scheduling based on the external scheduling power limit and the preceding policies.

Working Mode	Mode Description
<p>Charge/Discharge based on grid dispatch</p>	<ul style="list-style-type: none"> - This mode applies to utility-scale plant scheduling scenarios where a third-party controller delivers active power scheduling commands. - The purpose of scheduled discharge is to meet the active power scheduling target value at the grid access point. PV energy is preferred. If the generated PV energy is insufficient, the batteries discharge and the energy is fed to the grid based on the active power scheduling target value. If the generated PV energy is sufficient, the energy is fed to the grid based on the active power scheduling target value, and the surplus PV energy is used to charge the batteries. - The purpose of scheduled charge is to meet the active power scheduling target value at the grid access point. If the battery charge power is insufficient or the Smart PCS limits the power, the grid charges the batteries with the maximum capability. If the batteries are not fully charged when the scheduling target value is met, the PV power is used to charge the batteries.
<p>Custom^[2]</p>	<ul style="list-style-type: none"> - This mode applies to utility-scale plant (with ESSs) scheduling scenarios. Customers can control the battery discharge power. - Non-discharge period: The batteries cannot discharge and can be charged based on the scheduling command. - Discharge period: If Adaptive discharge power is enabled, the control logic is the same as that for scheduled charge and discharge. The battery charge and discharge power is determined by the upper-layer scheduling command. If Adaptive discharge power is disabled, the battery discharge power is fixed to the reference value set by the customer. In this case, the upper-layer scheduling command controls only the PV inverters but not the batteries.
<p>Note [1]: You can set this parameter in SmartLogger V300R023C00SPC150 and later versions.</p> <p>Note [2]: You can set this parameter in SmartLogger V300R023C00SPC120 and later versions.</p>	

Table 6-6 Running parameters in each battery control working mode

Working Mode	Parameter	Description
Maximum self-consumption	Active power threshold of grid during battery discharge	Set the grid power threshold at the grid connection point for loads when the load power is greater than the PV power.
	Adjustment deadband	Set the precision of the grid power at the grid connection point. This parameter affects the power value range at the grid connection point. If the actual grid power threshold at the grid connection point is within this range, i.e. [Maximum grid power during battery discharge – Adjustment deadband, Maximum grid power during battery discharge + Adjustment deadband], the grid power requirement at the grid connection point is met.
	Adaptive adjustment parameters^[1]	Set the adjustment period and step parameters for raising the inverter power. <ul style="list-style-type: none"> – Enable: The adjustment period and step set in the SmartLogger are used. Generally, the adjustment period and step are calculated based on the number of devices connected to the port and device specifications. – Disable: Use this value based on site requirements.

Working Mode	Parameter	Description
	Adjustment period ^[1]	This parameter is displayed after Adaptive adjustment parameters is set to Disable . You can set this parameter based on site requirements. In this case, battery control is performed based on the preset period.
	PV adjustment step ^[1]	This parameter is displayed after Adaptive adjustment parameters is set to Disable . You can set this parameter based on site requirements. In this case, the PV rise step for PV+ESS equalization is the preset value.
TOU	Preferred use of surplus PV power	<ul style="list-style-type: none"> - Charge: When the PV power is greater than the load power, the surplus PV energy is used to charge the batteries. After the maximum charge power is reached or the batteries are fully charged, the surplus PV energy is fed to the grid. - Fed to grid: When the PV power is greater than the load power, the surplus PV energy is preferentially fed to the grid. When the maximum output power of the device is reached, the surplus energy is used to charge the batteries. This setting is applicable to the scenario where the FIT is higher than the electricity price. The grid cannot charge the batteries.

Working Mode	Parameter	Description
	Maximum power for charging batteries from grid	Set the maximum power at which the grid charges the batteries.
	Active power threshold of grid during battery discharge	Set the grid power threshold at the grid connection point for loads when the load power is greater than the PV power.
	Adjustment deadband	Set the precision of the grid power at the grid connection point. This parameter affects the power value range at the grid connection point. If the actual grid power threshold at the grid connection point is within this range, i.e. [Maximum grid power during battery discharge – Adjustment deadband, Maximum grid power during battery discharge + Adjustment deadband], the grid power requirement at the grid connection point is met.
	Adaptive adjustment parameters^[1]	<p>Set the adjustment period and step parameters for raising the inverter power.</p> <ul style="list-style-type: none"> – Enable: The adjustment period and step set in the SmartLogger are used. Generally, the adjustment period and step are calculated based on the number of devices connected to the port and device specifications. – Disable: Use this value based on site requirements.

Working Mode	Parameter	Description
	Adjustment period^[1]	This parameter is displayed after Adaptive adjustment parameters is set to Disable . You can set this parameter based on site requirements. In this case, battery control is performed based on the preset period.
	PV adjustment step^[1]	This parameter is displayed after Adaptive adjustment parameters is set to Disable . You can set this parameter based on site requirements. In this case, the PV rise step for PV+ESS equalization is the preset value.
	Start time	Set the start time and end time of charge and discharge. A maximum of 14 time segments can be set. You can set a cycle by week by clicking the buttons corresponding to Mon. through Sun. in the Repeat box. The buttons are blue by default, indicating being selected. After you click it, the button turns gray.
	End time	
	Charge/Discharge	
Repeat		
TOU (fixed power)	Start time	Set the start time, end time, and power of charge and discharge. A maximum of 14 time segments can be set. You can set a cycle by week by clicking the buttons corresponding to Mon. through Sun. in the Repeat box. The buttons are blue by default, indicating being selected. After you click it, the button turns gray.
	End time	
	Charge/Discharge	
	Charge/Discharge power (kW)	
	Repeat	

Working Mode	Parameter	Description
Charge/Discharge based on grid dispatch	Adaptive adjustment parameters ^[1]	Set the adjustment period and step parameters for raising the inverter power. <ul style="list-style-type: none"> – Enable: The adjustment period and step set in the SmartLogger are used. Generally, the adjustment period and step are calculated based on the number of devices connected to the port and device specifications. – Disable: Use this value based on site requirements.
	Adjustment period ^[1]	This parameter is displayed after Adaptive adjustment parameters is set to Disable . You can set this parameter based on site requirements. In this case, battery control is performed based on the preset period.
	PV adjustment step ^[1]	This parameter is displayed after Adaptive adjustment parameters is set to Disable . You can set this parameter based on site requirements. In this case, the PV rise step for PV+ESS equalization is the preset value.
	Array end-of-charge SOC	The default value is 100%. The default value is recommended. Set this parameter as required.
	Array end-of-discharge SOC	The default value is 5%. The default value is recommended. Set this parameter as required.

Working Mode	Parameter	Description
	Array end-of-charge/ discharge SOC derating	The default value is Disable . The default value is recommended. Set this parameter as required. After this parameter is enabled, the SmartLogger will be derated according to a certain slope to prevent sudden power changes of arrays at the cut-off SOC point.
	Control charge/ discharge time window	The default value is Disable . The default value is recommended. Set this parameter as required. You can set the time segment for charge forbidden, discharge forbidden, charge, and discharge only after the control charge/discharge time window is enabled.
	Start time	Set the start time, end time, and power of charge forbidden, discharge forbidden, charge, and discharge. A maximum of 14 time segments can be set. You can set a cycle by week by clicking the buttons corresponding to Mon. through Sun. in the Repeat box. The buttons are blue by default, indicating being selected. After you click it, the button turns gray.
	End time	
	Charge/Discharge	
	Charge/Discharge power (kW)	
	Repeat	
	Protection against communication disconnection	

Working Mode	Parameter	Description
Custom	ESS discharge start time	Set the start time of battery discharge. During the period from the start time to the end time, the batteries can be charged and can discharge. Beyond the period, the batteries cannot discharge and can only be charged.
	ESS discharge end time	Set the end time of battery discharge. During the period from the start time to the end time, the batteries can be charged and can discharge. Beyond the period, the batteries cannot discharge and can only be charged.
	Adaptive discharge power	<ul style="list-style-type: none"> - Enable: PV power supply is preferred. If the PV power is insufficient, the batteries supply power to loads; if the PV power is sufficient, the system outputs at the target value and the surplus PV power is used to charge the batteries. - Disable: Batteries discharge based on the discharge power set on the GUI.
	Reference discharge power	Set the battery discharge power during the discharge period.

Working Mode	Parameter	Description
	Adaptive adjustment parameters^[1]	Set the adjustment period and step parameters for raising the inverter power. <ul style="list-style-type: none"> - Enable: The adjustment period and step set in the SmartLogger are used. Generally, the adjustment period and step are calculated based on the number of devices connected to the port and device specifications. - Disable: Use this value based on site requirements.
	Adjustment period^[1]	This parameter is displayed after Adaptive adjustment parameters is set to Disable . You can set this parameter based on site requirements. In this case, battery control is performed based on the preset period.
	PV adjustment step^[1]	This parameter is displayed after Adaptive adjustment parameters is set to Disable . You can set this parameter based on site requirements. In this case, the PV rise step for PV+ESS equalization is the preset value.
Note [1]: This parameter is added in SmartLogger V300R023C00SPC120 and later versions. This parameter is displayed and needs to be set only when the Smart PCS is connected.		

- Set the automatic calibration functions.

Parameter	Description
<p>Automatic SOC calibration</p>	<ul style="list-style-type: none"> - If this parameter is set to Enable, automatic charge and discharge calibration is allowed for battery racks. During calibration, the cut-off SOC settings will be ineffective and the response of the charge and discharge power may be impacted temporarily. - If this parameter is set to Disable, automatic charge and discharge calibration is not allowed for battery racks.
<p>Automatic SOC calibration interval^[1]</p>	<p>Set the automatic SOC calibration interval. This parameter is displayed when Automatic SOH calibration is set Enable.</p> <p>If the battery SOC stays in the range of 10% to 99% most of the time, for example, in the microgrid scenario, the recommended online calibration interval is less than or equal to 7 days.</p> <p>If the battery SOC stays in the range of 40% to 60% most of the time, for example, in the frequency regulation scenario, the recommended online calibration interval is less than or equal to 30 days.</p> <p>If the battery SOC stays below 10% or at 100% most of the time, for example, in the peak shaving scenario, the recommended online calibration interval is less than or equal to 180 days.</p>
<p>Automatic SOH calibration</p>	<ul style="list-style-type: none"> - If this parameter is set to Enable, the ESS automatically calibrates the SOH precision and fully charges and discharges each battery rack in turn. - If this parameter is set to Disable, automatic SOH calibration is not allowed for battery racks.
<p>Note [1]: You can set this parameter in SmartLogger V300R023C00SPCXXX and later versions.</p>	

- Set **PCS insulation resistance detection**.
If a dialog box **You are advised to change the insulation resistance detection time to the optimal time (XX:XX)** is displayed, you are advised to click **Confirm** and set **Detection start time** to the optimal time. This policy applies only to the C&I scenario and is supported in SmartLogger V300R023C00SPC172 and later versions.

Table 6-7 Setting parameters related to PCS insulation resistance detection

Parameter	Description
Detection start time ^[1]	It indicates the time when the PCS insulation resistance detection function is enabled. The default value is 02:00.
Note [1]: You can set this parameter in SmartLogger V300R023C00SPC153 and later versions.	

Step 6 Connect to the Huawei NMS.

Figure 6-23 Huawei NMS

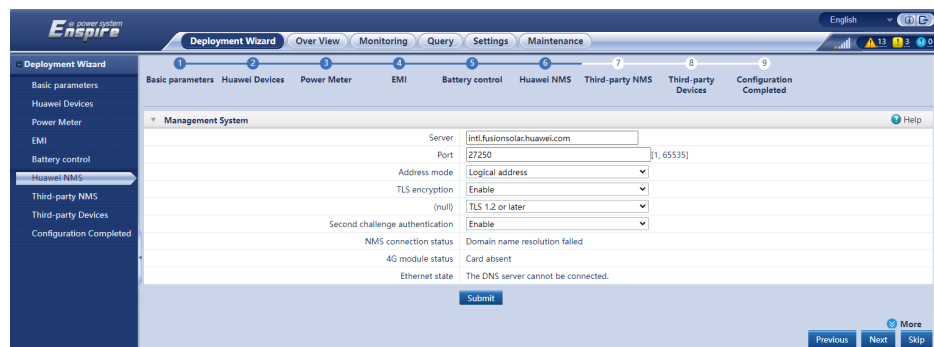

Step 7 For third-party NMS access, select a protocol based on the actual third-party NMS protocol.

Figure 6-24 Third-party NMS

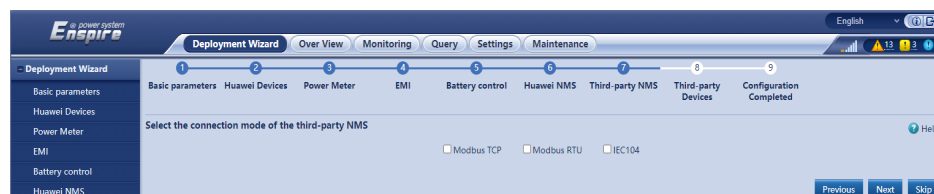

Step 8 Connect to third-party devices.

Figure 6-25 Third-party devices

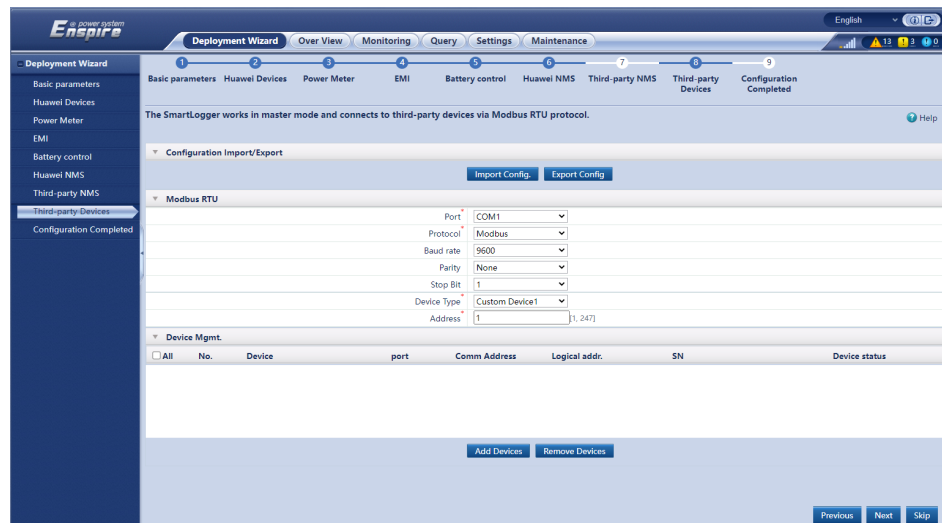

Step 9 Set **Array startup/shutdown** based on the site requirements. The configuration is complete.

Figure 6-26 Completing the configuration

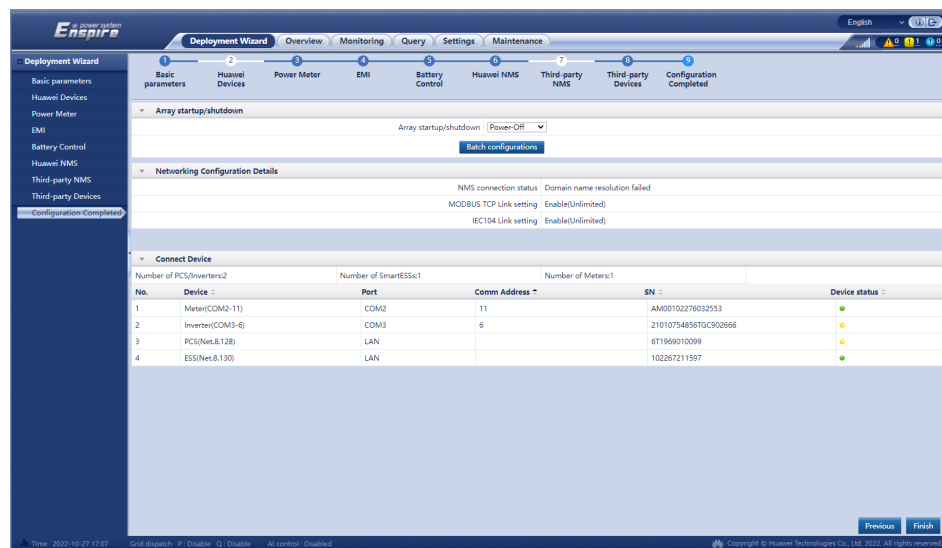

----End

6.3 Parameter Settings

NOTICE

- If the parameters listed in this section have been set in **Deployment Wizard**, ignore the corresponding settings.
- If the PV and energy storage plants do not contain certain devices, such as power meters, EMIs, IEC103 devices, custom devices, and IEC104 devices, ignore the corresponding settings.

6.3.1 Setting User Parameters

Set user parameters and click **Submit**.

Figure 6-27 Setting user parameters

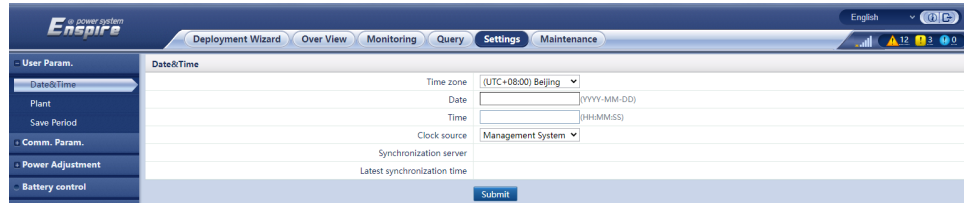

Date&Time

Parameter	Description
Local time zone	Select a time zone based on the region where the plant is located.
DST enable	Set this parameter as required. NOTE This parameter is unavailable for zones without DST.
Date	Set this parameter to the local date.
Time	Set this parameter to the local time.
Clock source	<ul style="list-style-type: none"> Set this parameter as required. The value can be NTP, Management System, IEC104, or Modbus TCP. If there is no management system, ignore the corresponding setting.

NOTICE

- After the date and time are set, the date and time of all the inverters connected to the SmartLogger are updated accordingly. Ensure that the settings are correct.
- Changing the date and time affects the recording of system energy yield and performance data. Do not change the time zone or system time unless necessary.

Plant

Parameter	Description
Plant name	Set this parameter as required.
Plant address	NOTE In the English half-width status, you cannot enter any of the following characters: <>,'?()#&\\$ %+;~^"
Plant owner	
Plant owner address	
Country/Region	Select a country/region based on the region where the PV plant is located.

Revenue

NOTE

This parameter can be set only in the PV scenario.

Parameter	Description
Currency	Set this parameter as required. The value can be EUR, GBP, USD, CNY, or JPY .
Electricity price/kWh	Set this parameter to the local electricity price, which is used to calculate the converted revenue of the energy yield.
CO2 emission reduction coefficient	Set this parameter based on the local standard.

Save Period

Parameter	Description
Performance data save period	Set this parameter to the save period of performance data. After the setting, the data will be displayed accordingly on the performance data page.

6.3.2 Setting Parameters for Connecting to the Management System (V300R001C00)

Procedure

Step 1 Set up a network connection.

- **Method 1:** When the SmartLogger connects to the management system over the 4G/3G/2G network, set mobile data parameters and click **Submit**.

Figure 6-28 Setting mobile data parameters

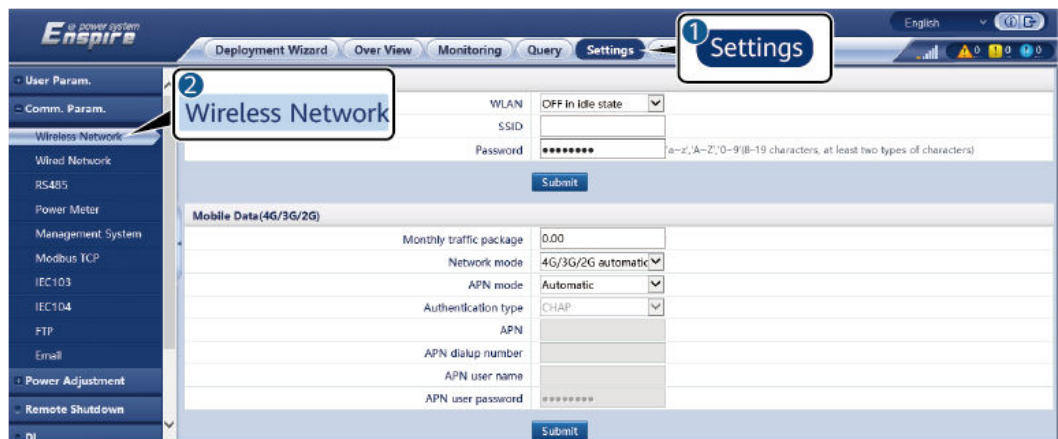

IL04J00002

Parameter	Description
Monthly traffic package	Set this parameter based on the SIM card traffic package.
Network mode	Set this parameter based on the SIM card network mode.
APN mode	The default value is Automatic . Set this parameter to Manual if the dial-up connection cannot be set up in Automatic mode.
Authentication type	When APN mode is set to Manual , you need to set the parameters related to the SIM card. Obtain the information about the parameters from the SIM card operator.
APN	
APN dialup number	
APN user name	
APN user password	

- **Method 2:** When the SmartLogger connects to the management system over a wired network, set the wired network parameters and click **Submit**.

Figure 6-29 Setting wired network parameters

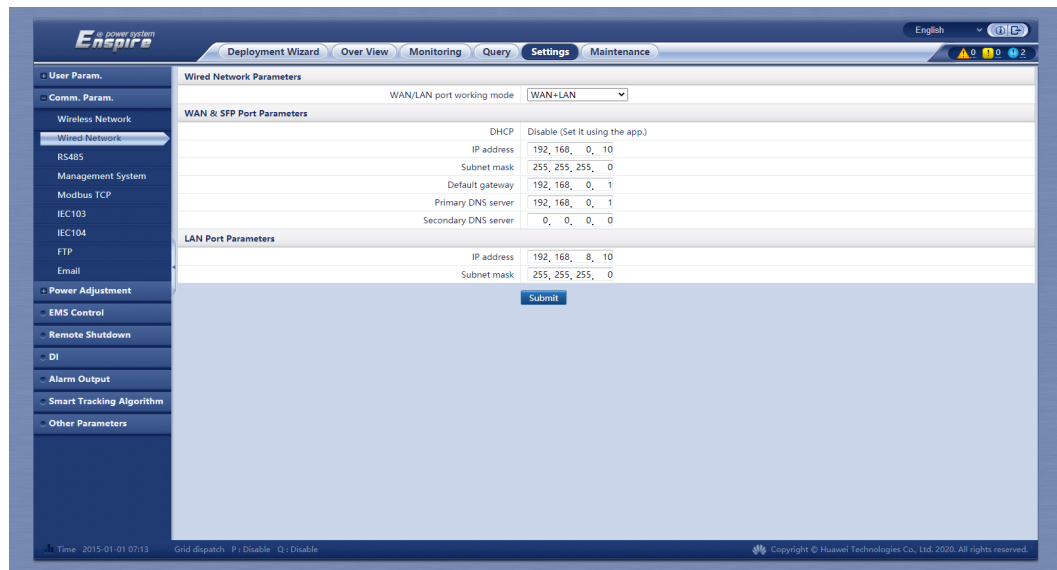

Parameter	Description
WAN/LAN port working mode	<p>Three working modes are supported: WAN+LAN, LAN+LAN, and WAN+WAN.</p> <ul style="list-style-type: none"> • If WAN+LAN is selected, the functions and IP addresses of the SmartLogger WAN and LAN ports remain unchanged. • If LAN+LAN is selected, the SmartLogger WAN and LAN ports function as LAN ports, and the SmartLogger WAN and LAN ports share a LAN IP address. • If WAN+WAN is selected, the SmartLogger WAN and LAN ports function as WAN ports, and the SmartLogger WAN and LAN ports share a WAN IP address. <p>NOTICE When the working mode of the WAN/LAN port is switched, the web page may be interrupted or the SmartModule may be powered off.</p>
DHCP	<p>The WAN port of the SmartLogger supports IP address obtaining using DHCP and automatic registration.</p> <p>NOTE After the SmartLogger connects to the SUN2000 app or FusionSolar app, tap More > Settings > Comm. Param. > Ethernet to access the Ethernet parameter setting screen and set DHCP to Enable.</p>
IP Address	<p>Set this parameter based on the plant plan.</p> <p>NOTE If the IP address is changed, use the new IP address to log in again.</p>

Parameter	Description
Subnet mask	Set this parameter based on the actual subnet mask of the LAN where the SmartLogger is located.
Default gateway	Set this parameter based on the actual gateway of the LAN where the SmartLogger is located.
Primary DNS server	<ul style="list-style-type: none"> You can ignore this parameter if the SmartLogger connects to the LAN. Set this parameter to the IP address of the LAN router when the SmartLogger connects to the public network (for example, connecting to the FusionSolar SmartPVMS, email server, or third-party FTP server).
Secondary DNS server	<ul style="list-style-type: none"> In normal cases, you can ignore this parameter. If the primary DNS server cannot resolve the domain name, the secondary DNS server is used.

Step 2 Set management system parameters.

- **Method 1:** When the SmartLogger connects to a Huawei or third-party management system using the encrypted Modbus TCP protocol, set management system parameters and click **Submit**.

NOTE

After a Huawei NMS or a third-party NMS is connected to the SmartLogger in **Management System**, another third-party NMS can be connected through **Management System-1** to obtain data from the SmartLogger and configure the SmartLogger.

Figure 6-30 Setting management system parameters

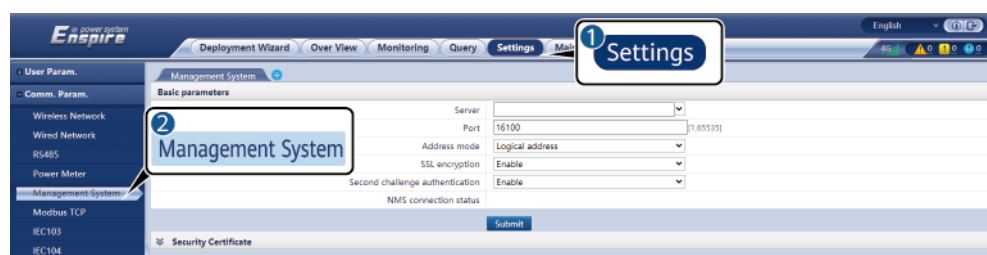

IL04J00003

Table 6-8 Management System

Parameter	Description
Server	Set this parameter to the IP address or domain name of the Management System .
Port	Set this parameter based on the connected Management System .

Parameter	Description
Address mode	The value can be Comm. Address or Logical address . If the communications address of the device connected to the SmartLogger is unique, you are advised to select Comm. Address . In other cases, you must select Logical address .
SSL encryption	Retain the default value Enable . NOTE If this parameter is set to Disable , data exchange between the SmartLogger and the management system will not be encrypted, which poses security risks.
Second challenge authentication	Set this parameter based on the connected management system. NOTE If this parameter is set to Disable , the second challenge authentication result is not checked, and user data may be stolen. Therefore, exercise caution when setting this parameter.
Security certificate	Optional. Set this parameter only when the certificate has expired or the customer needs to use their own certificate.

Figure 6-31 Setting management system-1 parameters



Table 6-9 Management system-1 parameters

Parameter	Description
Server	Set this parameter to the IP address or domain name of Management System-1 .
Port	Set this parameter based on the connected Management System-1 .
Address mode	The value can be Comm. Address or Logical address . If the communications address of the device connected to the SmartLogger is unique, you are advised to select Comm. Address . In other cases, you must select Logical address .

Parameter	Description
TLS encryption	Retain the default value Enable . NOTE If this parameter is set to Disable , data exchange between the SmartLogger and the management system will not be encrypted, which poses security risks.
TLS version	Set this parameter based on the connected Management System-1 . TLS1.2 or a later version is recommended.
Remote permission	Monitoring only, Management (permanent authorization), and Management (temporary authorization) are supported. When the remaining authorization time becomes 0, the system automatically switches to the monitoring-only mode.
Authorization time	Set this parameter based on the actual authorization time.

- **Method 2:** When the SmartLogger connects to a third-party management system using the unencrypted Modbus TCP protocol, set Modbus TCP parameters and click **Submit**.

Figure 6-32 Setting Modbus TCP parameters

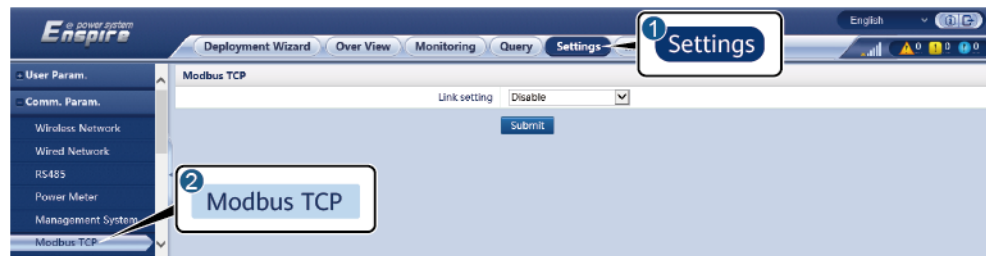

IL03J00008

Parameter	Description
Link setting	<p>Modbus TCP is a universal standard protocol used to connect to a third-party management system. Because there is no security authentication mechanism, data transmitted by Modbus TCP is not encrypted. To reduce network security risks, the function of connecting to a third-party management system using Modbus TCP is disabled by default. This protocol can transmit the running data and control commands of PV plants, which may cause user data breach and control permission theft. Therefore, exercise caution when using this protocol. Users are liable for any loss caused by the use of this protocol to connect to a third-party management system (non-secure protocol). Users are advised to take measures at the plant level to reduce security risks, or use Huawei management system to mitigate the risks.</p> <p>To use this function, set this parameter to Enable(Limited) or Enable(Unlimited).</p> <ul style="list-style-type: none"> • If this parameter is set to Enable(Limited), the SmartLogger can connect to a maximum of five preset third-party management systems. • If this parameter is set to Enable(Unlimited), the SmartLogger can connect to a maximum of five third-party management systems with a valid IP address.
Client N IP Address NOTE N is 1, 2, 3, 4, or 5.	If Link setting is set to Enable(Limited) , set this parameter based on the IP address of the third-party management system.
Address mode	<p>The value can be Comm. Address or Logical address.</p> <p>If the communications address of the device connected to the SmartLogger is unique, you are advised to select Comm. Address. In other cases, you must select Logical address.</p>
SmartLogger address	Set this parameter to the communication address of the SmartLogger.

- **Method 3:** When the SmartLogger connects to a third-party management system over IEC104, set IEC104 parameters and click **Submit**.

Figure 6-33 Setting IEC104 parameters

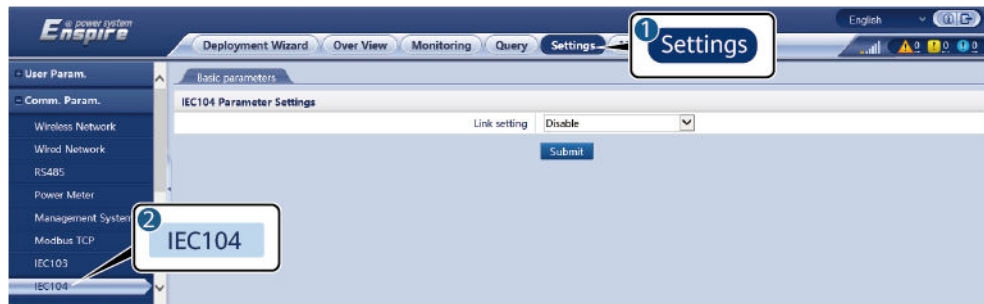

IL04J00004

Tab	Parameter	Description
Basic parameters	Link setting	<p>IEC104 is a universal standard protocol used to connect to a third-party management system. Because there is no security authentication mechanism, data transmitted by IEC104 is not encrypted. To reduce network security risks, the function of connecting to a third-party management system using IEC104 is disabled by default. This protocol can transmit the running data and control commands of PV plants, which may cause user data breach and control permission theft. Therefore, exercise caution when using this protocol. Users are liable for any loss caused by the use of this protocol to connect to a third-party management system (non-secure protocol). Users are advised to take measures at the PV plant level to reduce security risks, or use Huawei management system to mitigate the risks.</p> <p>To use this function, set this parameter to Enable(Limited) or Enable(Unlimited).</p> <ul style="list-style-type: none"> If this parameter is set to Enable(Limited), the SmartLogger can connect to a maximum of five preset third-party management systems. If this parameter is set to Enable(Unlimited), the SmartLogger can connect to a maximum of five third-party management systems with a valid IP address.
	Public IP address	Set these parameters as required.

Tab	Parameter	Description
IEC104-N NOTE N is 1, 2, 3, 4, or 5.	IEC104-N IP	If Link setting is set to Enable(Limited) , set this parameter based on the IP address of the third-party management system.
	Teleindication default segment	Set these parameters as required. NOTE After the IEC104 configuration file exported from the SmartLogger and the IEC104 information files delivered with devices are correctly configured in a third-party management system, the third-party management system will be able to monitor devices connected to the SmartLogger over the IEC104 protocol.
	Telemetry default segment	
	Forwarding Table	
Common Configuration	Teleindication default segment	If Link setting is set to Enable(Unlimited) , set these parameters as required. NOTE After the IEC104 configuration file exported from the SmartLogger and the IEC104 information files delivered with devices are correctly configured in a third-party management system, the third-party management system will be able to monitor devices connected to the SmartLogger over the IEC104 protocol.
	Telemetry default segment	
	Forwarding Table	

 **NOTE**

Choose **Settings > Other Parameters**, and set **IEC104 Push Data Period** to specify the interval for the SmartLogger to push data to a third-party management system over IEC104. If **IEC104 Push Data Period** is set to 0s, there is no limit on the interval at which the SmartLogger sends IEC104 data.

----End

6.3.3 Setting Parameters for Connecting to the Management System

Procedure

Step 1 Set up a network connection.

- **Method 1:** If the SmartLogger connects to the management system over a 4G/3G/2G network, choose **Settings > Comm. Param. > Wireless Network**, set mobile data parameters, and click **Submit**.

Parameter	Description
Monthly traffic package	Set this parameter based on the SIM card traffic package.
Network mode	Set this parameter based on the SIM card network mode.
APN mode	The default value is Automatic . Set this parameter to Manual if the dial-up connection cannot be set up in Automatic mode.
Authentication type	When APN mode is set to Manual , you need to set the parameters related to the SIM card. Obtain the information about the parameters from the SIM card operator.
APN	
APN dialup number	
APN user name	
APN user password	

- **Method 2:** If the SmartLogger connects to the management system over a wired network, choose **Settings > Comm. Param. > Wired Network**, set wired network parameters, and click **Submit**.

Parameter	Description
WAN/LAN/SFP port	<p>Supports five configurations: Ethernet1/Ethernet2/Ethernet1, Ethernet2/Ethernet2/Ethernet1, Ethernet1/Ethernet1/Ethernet1, Ethernet1/Ethernet2/Ethernet2, and Ethernet1/Ethernet2/Ethernet3.</p> <ul style="list-style-type: none"> • Ethernet1/Ethernet2/Ethernet1 is used for a fiber ring network between the SACUs or an FE network between southbound devices and the SACUs, indicating that the WAN/SFP port is Ethernet1 and the LAN port is Ethernet2. • Ethernet2/Ethernet2/Ethernet1 is used to connect the LAN port of a third-party device or for a northbound network of the SACUs through the optical port, indicating that the WAN/LAN port is Ethernet2 and the SFP port is Ethernet1. • Ethernet1/Ethernet1/Ethernet1 is used for communication between the WAN/LAN/SFP port, indicating that the WAN/LAN/SFP port is Ethernet1. • Ethernet1/Ethernet2/Ethernet2 is used for a northbound network of the SACUs through the WAN port when the optical port is directly connected to the CMU, indicating that the WAN port is Ethernet1 and the LAN/SFP port is Ethernet2. • Ethernet1/Ethernet2/Ethernet3 is used when the three networks are isolated and different network segments are configured, indicating that the WAN port is Ethernet1, the LAN port is Ethernet2, and the SFP port is Ethernet3.
RSTP root node	<p>This parameter is displayed when WAN/LAN/SFP port is set to Ethernet1/Ethernet2/Ethernet2 for a northbound network of the SACUs through the WAN port when the optical port is directly connected to the CMU. Set this parameter to Enabled.</p> <p>NOTE</p> <ul style="list-style-type: none"> • After this parameter is set to Enabled or Disabled, the SmartLogger automatically restarts. • If this parameter is set to Disabled, the communication network may be unstable. Exercise caution when setting this parameter.
DHCP	<p>The WAN port of the SmartLogger supports IP address obtaining using DHCP and automatic registration.</p> <p>NOTE</p> <p>After the SmartLogger connects to the SUN2000 app or FusionSolar app, tap More > Settings > Comm. Param. > Ethernet to access the Ethernet parameter setting screen and set DHCP to Enable.</p>

Parameter	Description
IP Address	Set this parameter based on the plant plan. NOTE If the IP address is changed, use the new IP address to log in again.
Subnet mask	Set this parameter based on the actual subnet mask of the LAN where the SmartLogger is located.
Default gateway	Set this parameter based on the actual gateway of the LAN where the SmartLogger is located.
Primary DNS server	You can ignore this parameter if the SmartLogger connects to the LAN. Set this parameter to the IP address of the LAN router when the SmartLogger connects to the public network (for example, connecting to the FusionSolar SmartPVMS, email server, or third-party FTP server).
Secondary DNS server	In normal cases, you can ignore this parameter. If the primary DNS server cannot resolve the domain name, the secondary DNS server is used.

Step 2 Choose **Settings > Comm. Param. > Management System** and set management system parameters.

- **Method 1:** When the SmartLogger connects to a Huawei or third-party management system using the encrypted Modbus TCP protocol, set management system parameters and click **Submit**.

NOTE

After a Huawei NMS or a third-party NMS is connected to the SmartLogger in **Management System**, another third-party NMS can be connected through **Management System-1** to obtain data from the SmartLogger and configure the SmartLogger.

Figure 6-34 Setting management system parameters

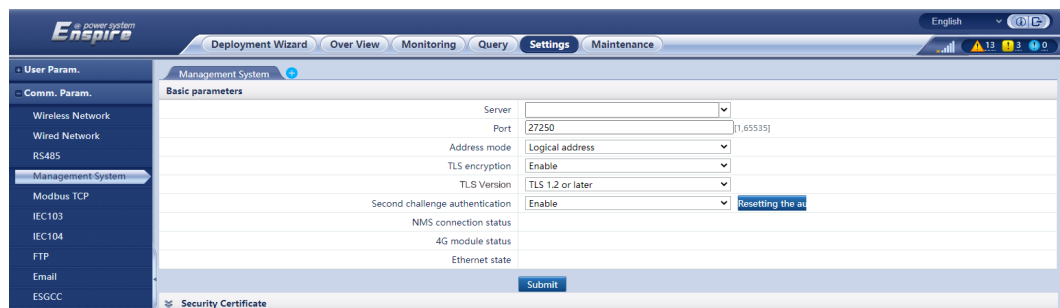

Table 6-10 Management system parameters

Parameter	Description
Server	Set this parameter to the IP address or domain name of the Management System .
Port	Set this parameter based on the connected Management System .
Address mode	The value can be Comm. Address or Logical address . If the communications address of the device connected to the SmartLogger is unique, you are advised to select Comm. Address . In other cases, you must select Logical address .
TLS encryption	Retain the default value Enable . NOTE If this parameter is set to Disable , data exchange between the SmartLogger and the management system will not be encrypted, which poses security risks.
TLS version	Set this parameter based on the connected Management System . TLS1.2 or a later version is recommended.
Second challenge authentication	Set this parameter based on the connected management system. NOTE If this parameter is set to Disable , the second challenge authentication result is not checked, and user data may be stolen. Therefore, exercise caution when setting this parameter.
Security certificate	Optional. Set this parameter only when the certificate has expired or the customer needs to use their own certificate.

Figure 6-35 Setting management system-1 parameters

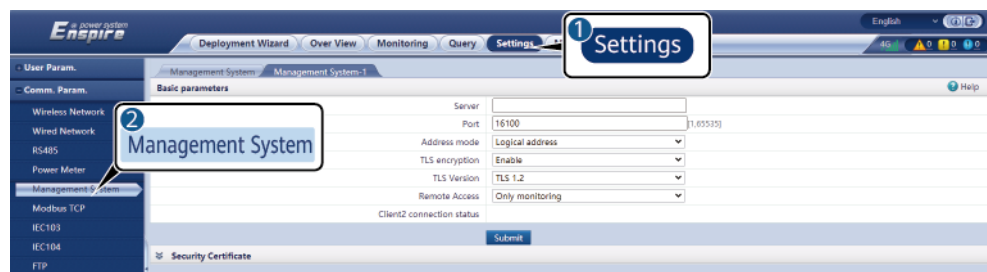
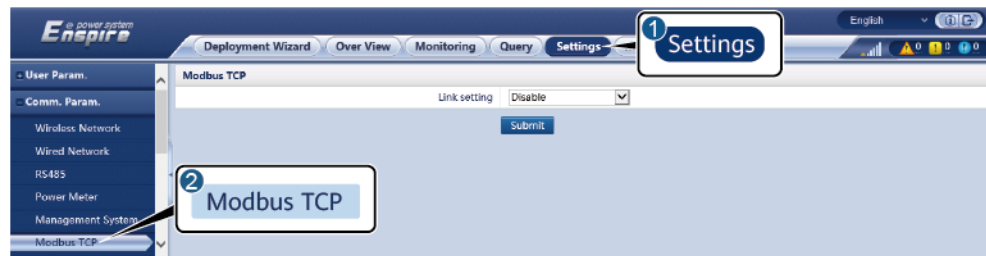

Table 6-11 Management system-1 parameters

Parameter	Description
Server	Set this parameter to the IP address or domain name of Management System-1 .
Port	Set this parameter based on the connected Management System-1 .
Address mode	The value can be Comm. Address or Logical address . If the communications address of the device connected to the SmartLogger is unique, you are advised to select Comm. Address . In other cases, you must select Logical address .
TLS encryption	Retain the default value Enable . NOTE If this parameter is set to Disable , data exchange between the SmartLogger and the management system will not be encrypted, which poses security risks.
TLS version	Set this parameter based on the connected Management System-1 . TLS1.2 or a later version is recommended.
Remote permission	Monitoring only, Management (permanent authorization), and Management (temporary authorization) are supported. When the remaining authorization time becomes 0, the system automatically switches to the monitoring-only mode.

- **Method 2:** When the SmartLogger connects to a third-party management system using the unencrypted Modbus TCP protocol, set Modbus TCP parameters and click **Submit**.

Figure 6-36 Setting Modbus TCP parameters



IL03J00008

Parameter	Description
Link setting	<p>Modbus TCP is a universal standard protocol used to connect to a third-party management system. Because there is no security authentication mechanism, data transmitted over this protocol is not encrypted. To reduce network security risks, the function of connecting to a third-party management system using Modbus TCP is disabled by default. This protocol can transmit the running data and control commands of PV plants, which may cause user data breach and control permission theft. Therefore, exercise caution when using this protocol. Users are liable for any loss caused by connecting to a third-party management system (non-secure protocol) using this protocol. Users are advised to take measures at the PV plant level to reduce security risks, or use Huawei management system to mitigate the risks.</p> <p>To use this function, set this parameter to Enable(Limited) or Enable(Unlimited).</p> <ul style="list-style-type: none"> • If this parameter is set to Enable(Limited), the SmartLogger can connect to a maximum of five preset third-party management systems. • If this parameter is set to Enable(Unlimited), the SmartLogger can connect to a maximum of five third-party management systems with a valid IP address.
Client N IP Address NOTE N is 1, 2, 3, 4, or 5.	If Link setting is set to Enable(Limited) , set this parameter based on the IP address of the third-party management system.
Address mode	<p>The value can be Comm. Address or Logical address.</p> <p>If the communications address of the device connected to the SmartLogger is unique, you are advised to select Comm. Address. In other cases, you must select Logical address.</p>
SmartLogger address	Set this parameter to the communication address of the SmartLogger.

- **Method 3:** When the SmartLogger connects to a third-party management system over IEC 104, set IEC 104 parameters and click **Submit**.

Figure 6-37 Setting IEC 104 parameters

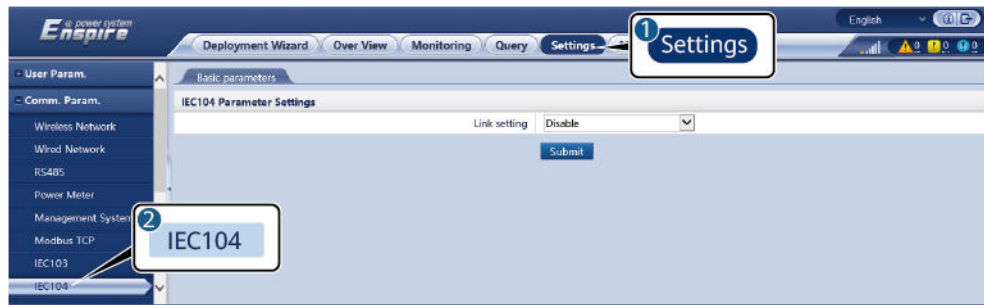

IL04J00004

Tab	Parameter	Description
Basic parameters	Link setting	<p>IEC 104 is a universal standard protocol used to connect to a third-party management system. Because there is no security authentication mechanism, data transmitted over this protocol is not encrypted. To reduce network security risks, the function of connecting to a third-party management system using IEC 104 is disabled by default. This protocol can transmit the running data and control commands of plants, which may cause user data breach and control permission theft. Therefore, exercise caution when using this protocol. Users are liable for any loss caused by connecting to a third-party management system (non-secure protocol) using this protocol. Users are advised to take measures at the plant level to reduce security risks, or use Huawei management system to mitigate the risks.</p> <p>To use this function, set this parameter to Enable(Limited) or Enable(Unlimited).</p> <ul style="list-style-type: none"> If this parameter is set to Enable(Limited), the SmartLogger communicates with the management system of the specified IP address, that is, using a whitelist. If this parameter is set to Enable(Unlimited), the SmartLogger sets the segments and common forwarding tables of teleindication and telemetry through Common Configuration.

Tab	Parameter	Description
	Public IP address	Set this parameter as required.
IEC104-N NOTE <ul style="list-style-type: none"> In SmartLogger V300R023C00 SPC120 and later versions, IEC104-1 to IEC104-10 are displayed. In versions earlier than SmartLogger V300R023C00 SPC120, IEC104-1 to IEC104-5 are displayed. 	IEC104-N IP	If Link setting is set to Enable(Limited) , set this parameter based on the IP address of the third-party management system.
	Teleindication default segment	Set this parameter as required. NOTE After the IEC 104 configuration file exported from the SmartLogger and the device type IEC 104 information files delivered with devices are correctly configured in a third-party management system, the third-party management system will be able to monitor devices connected to the SmartLogger over IEC 104.
	Telemetry default segment	
	Forwarding Table	
Common Configuration	Teleindication default segment	If Link setting is set to Enable(Unlimited) , set these parameters as required. NOTE After the IEC 104 configuration file exported from the SmartLogger and the device type IEC 104 information files delivered with devices are correctly configured in a third-party management system, the third-party management system will be able to monitor devices connected to the SmartLogger over IEC 104.
	Telemetry default segment	
	Forwarding Table	

 **NOTE**

Choose **Settings > Other Parameters**, and set **IEC104 Push Data Period** to specify the interval for the SmartLogger to push data to a third-party management system over IEC104. If **IEC104 Push Data Period** is set to 0s, there is no limit on the interval at which the SmartLogger sends IEC104 data.

----End

6.3.4 Setting RS485 Communications Parameters

Set RS485 parameters and click **Submit**.

Figure 6-38 Setting RS485 parameters



IL03J00010

NOTE

When the SmartModule is connected to the SmartLogger, the device name of the SmartModule is **Module(M1)**, and the corresponding port is **M1.COM**.

RS485

Protocol, Baud rate, Parity, and Stop Bit must be set to the same values for the devices connected to the same COM port.

Parameter	Description
Protocol	<p>Set this parameter based on the protocol type of the connected device.</p> <p>The value can be Modbus, IEC103, DL/T645, Modbus-Slave, or Modbus-Control.</p> <p>NOTE</p> <ul style="list-style-type: none"> When the SmartLogger serves as a slave node to interconnect with a third-party device over Modbus-RTU, set Protocol to Modbus-Slave. When the connected inverter performs rapid power grid scheduling using both MBUS and RS485, set Protocol to Modbus-Control.
Baud rate	<p>Set this parameter based on the baud rate of the connected device.</p> <p>The value can be 1200, 2400, 4800, 9600, 19200, or 115200.</p>
Parity	<p>Set this parameter based on the parity mode of the connected device.</p> <p>The value can be None, Odd parity, or Even parity.</p>
Stop Bit	<p>Set this parameter based on the stop bit of the connected device.</p> <p>The value can be 1 or 2.</p>

Parameter	Description
Start address	1 ≤ Start address ≤ Communication address of the connected device ≤ End address ≤ 247 The address segments of COM ports can overlap. NOTE The start and end addresses have no impact on the devices that have been connected.
End address	

Night Communication Settings

If device information query is not required at night, enable **Night silent**.

Parameter	Description
Night silent	Specifies whether the night silent mode is enabled.
Enter time	Specifies the time for entering the night silent mode.
Exit time	Specifies the time for exiting the night silent mode.
Wakeup period	Specifies the wakeup period for the night silent mode.

Records

The SmartLogger supports exporting of MBUS and RS485 communication packets.

Set **Choose port** and click **Start** to start packet recording. Then, click **Export** to stop packet recording and export the packets.

Parameter	Description
Choose port	Specifies the port for recording packets.
Record time	Sets the record time.

6.3.5 Setting SPPC Communications Parameters

NOTE

The parameters can be configured only for V300R023C10 and later versions.

Choose **Settings > Comm. Param. > SPPC**, set the SPPC parameters, and click **Submit**.

Parameter		Description
SPPC	SPPC IP	IP address of the SPPC. If the SPPC address is not configured, the SmartLogger obtains the SPPC address through the automatic discovery process. You can set the IP address to 0.0.0.0 and the port number to 65535 to manually start automatic device discovery.
	SPPC port number	Port number used by the SmartLogger to connect to the SPPC.
	Connection Status	Status of the SPPC connection.
Security Certificate	Upload CA certificate file	Update the CA certificate file. A CA certificate is a root certificate obtained from a CA. It is also called a trust certificate and is used to verify the identity certificate of the peer end.
	Upload local certificate file	Update the local certificate file. This is an identity certificate obtained from a CA. It is also called a device certificate and contains the public key of a device. During the establishment of a link with the peer end, the peer end uses its CA certificate to verify the validity and parses the certificate to obtain the public key of the local end.
	Upload key file	Update the key file. The secret key file is a certificate private key and is used by itself. After a link is established with the peer end, the secret key file is used to encrypt and send data.
	Enable key password	Whether to encrypt the key file. If this function is enabled, set Key password and Confirm key password .

6.3.6 Setting Parameters for the Slave SmartLogger

Step 1 Log in to the slave SmartLogger WebUI, set Modbus TCP parameters, and click **Submit**.

Figure 6-39 Setting Modbus TCP parameters

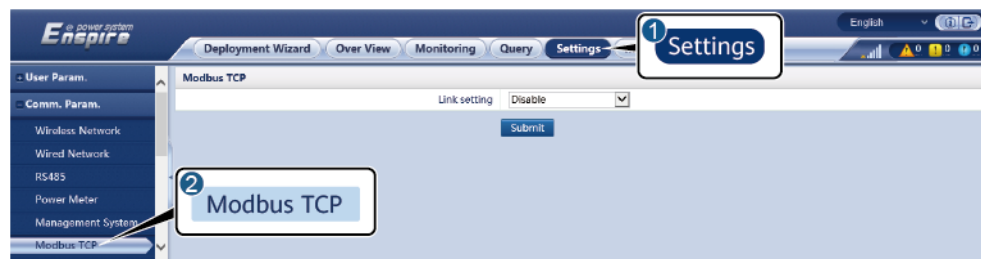

IL03J00008

Parameter	Description
Link setting	Set this parameter to Enable(Limited) .
Client N IP Address	Set this parameter to the IP address of the master SmartLogger.
Address mode	The value can be Comm. Address or Logical address . If the communications address of the device connected to the SmartLogger is unique, you are advised to select Comm. Address . In other cases, you must select Logical address .
SmartLogger address	Set this parameter to the communications address of the slave SmartLogger.
Fast scheduling ^[1]	The default value is Enable . <ul style="list-style-type: none"> Set this parameter to Enable to enable the fast scheduling function of the SmartLogger Modbus TCP interface. Set this parameter to Disable to disable the fast scheduling function of the SmartLogger Modbus TCP interface.
<p>Note [1]: This parameter can be set only for V300R023C00 and later versions. The fast scheduling function of the Modbus TCP interface is mutually exclusive with the GOOSE fast scheduling function. The fast scheduling function of only one protocol takes effect at a time.</p>	

Step 2 Log in to the WebUI of the master SmartLogger, set access parameters for the slave SmartLogger, and click **Add Devices**.

Figure 6-40 Setting access parameters

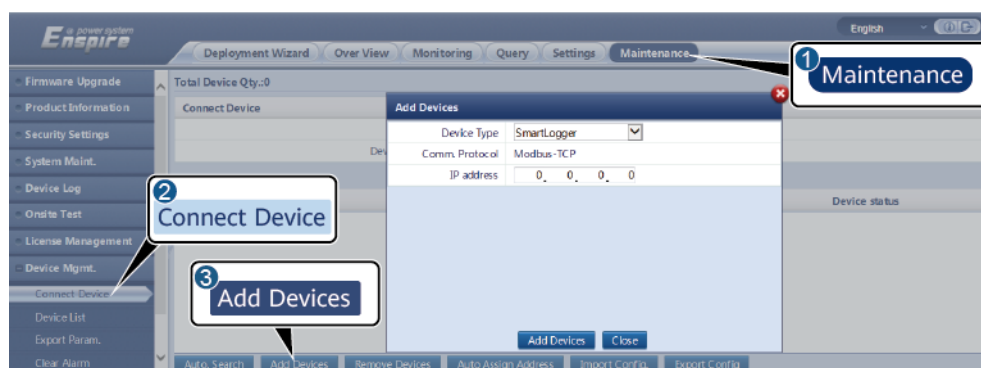

IL03J00011

Parameter	Description
Device Type	Set this parameter to SmartLogger .

Parameter	Description
IP address	Set this parameter to the IP address of the slave SmartLogger.

----End

6.3.7 Setting GOOSE Communications Parameters

NOTE

The GOOSE parameters can be configured only for V300R023C00 and later versions.

Choose **Settings > Comm. Param. > GOOSE**, set the GOOSE parameters, and click **Submit**.

Basic Parameters

Parameter	Description	Remarks
Connection	<p>The default value is Disable.</p> <ul style="list-style-type: none"> Set this parameter to Enable to enable GOOSE communication for the SmartLogger. Set this parameter to Disable to disable GOOSE communication for the SmartLogger. 	-
Data reporting	<p>The default value is Disable.</p> <ul style="list-style-type: none"> Set this parameter to Enable to enable the function of reporting GOOSE messages from the SmartLogger to the peer device. Set this parameter to Disable to disable the function of reporting GOOSE messages from the SmartLogger to the peer device. 	This parameter is displayed when Connection is set to Enable .
Data receiving	<p>The default value is Disable.</p> <ul style="list-style-type: none"> Set this parameter to Enable to enable the GOOSE message receiving function of the SmartLogger. Set this parameter to Disable to disable the GOOSE message receiving function of the SmartLogger. 	

Parameter	Description	Remarks
Network port	WAN or SPF is supported. The default value is WAN . This parameter specifies the type of the network port used by the SmartLogger to send and receive GOOSE messages. Set this parameter based on the actual networking scenario.	
Fast scheduling ^[1]	The default value is Disable . <ul style="list-style-type: none"> Set this parameter to Enable to enable the fast scheduling function of the SmartLogger GOOSE interface. Set this parameter to Disable to disable the fast scheduling function of the SmartLogger GOOSE interface. 	
Note [1]: The GOOSE fast scheduling function is mutually exclusive with the fast scheduling function of the Modbus TCP interface. The fast scheduling function of only one protocol takes effect at a time.		

Configuration File Import/Export

- This parameter is displayed when **Connection** is set to **Enable**.
- You can contact the vendor to obtain the CID files of the SmartLogger and the peer controller. Compress the CID files of the SmartLogger and the peer controller into a .zip configuration package, and click **Import Config**. Import the configuration package. After the configuration is parsed successfully, the **Device name**, **Controller type**, **Controller name**, **Configuration status**, and **Last import time** are displayed. For details about GOOSE interconnection and interfaces, see the *SmartLogger IEC61850 GOOSE Protocol Interface Description*.

If the configuration file is imported and parsed successfully, the configuration status is **Configured**. If the configuration file import fails, contact the vendor of the peer controller to obtain the correct CID file.

Message Indicating Failed Configuration	Description	Suggestion
Import failed. The configuration file is incomplete.	The CID file of the local or peer device is missing.	Contact the vendor of the peer controller to obtain the correct CID file.

Message Indicating Failed Configuration	Description	Suggestion
Import failed. The configuration file is not for this device.	The file does not match the vendor or the device type.	
Import failed. Unable to parse the configuration file.	The CID file format is incorrect. Parsing failed or no matching signal is found.	

- Click **Export Config.** to obtain the ICD file of the current SmartLogger version. The CID file is exported at the same time if it has been imported successfully.

6.3.8 Setting MBUS Parameters

6.3.8.1 Setting Parameters for a Built-in MBUS Module

Procedure

1. Set access parameters.

Figure 6-41 Setting parameters for a built-in MBUS module



IL03J00012

Parameter	Description
Built-in MBUS	<ul style="list-style-type: none"> • When the SmartLogger communicates with the inverter using a built-in MBUS module, set this parameter to Enable. • When the SmartLogger communicates with the inverter and third-party device only over RS485, set this parameter to Disable.

Parameter	Description
Device disconnection time	Specifies the device disconnection time.

2. Set networking parameters.

Figure 6-42 Setting built-in MBUS networking

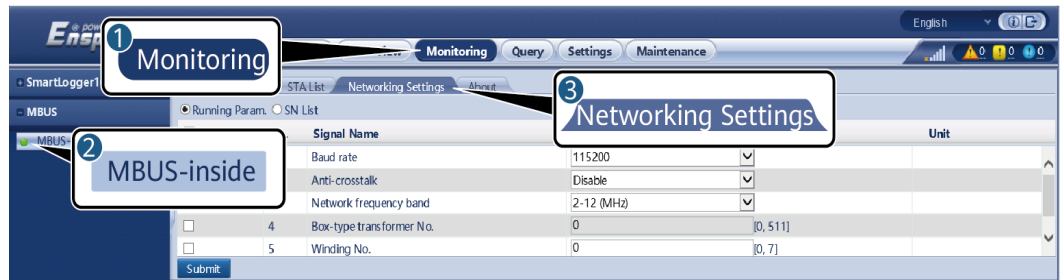

IL03J00014

Tab	Parameter	Description
Running Param.	Anti-crosstalk	Set this parameter to Enable . When the transformer station number and winding number of the inverter are the same as those of the MBUS, or the inverter SN is in the SN list, the inverter can connect to the SmartLogger over an MBUS network.
	Network frequency band	Set this parameter based on site requirements.
	Box-type transformer No.	Set this parameter based on the number of the transformer station connected to the SmartLogger.
	Winding No.	In the scenario of multi-split transformer stations, set this parameter based on the winding number of the transformer station connected to the SmartLogger.
	Networking	<ul style="list-style-type: none"> When the SmartLogger communicates with the inverter over MBUS, set Networking to Enable. When the SmartLogger communicates with the inverter only over RS485, set Networking to Disable.

Tab	Parameter	Description
	Power settings	This parameter is used to adjust the transmit power of MBUS signals. A larger value indicates higher transmit power and better networking capabilities. The default value is 8 (NA is displayed) . You can set this parameter based on actual requirements.
	Transmit mode^[1]	<ul style="list-style-type: none">• Set this parameter to Single-phase in the rapid power grid scheduling scenario and to Three-phase in other scenarios.• If this parameter is set to Single-phase, ensure that the MBUS three-phase AC power cable connection of the SmartLogger is the same as that of the inverter. Otherwise, the inverter communication may be disconnected or some commands may be lost.
	Fast control frame type^[2]	<ul style="list-style-type: none">• This parameter specifies the frame type used by the MBUS module for rapid power grid scheduling.• The MBUS module adaptively selects FC frame or Common frame.
	Fast scheduling^[3]	Set this parameter based on the actual networking. <ul style="list-style-type: none">• If the fast scheduling function is required, set this parameter to Enable.• If the fast scheduling function is not required, set this parameter to Disable.

Tab	Parameter	Description
SN List	-	<ul style="list-style-type: none"> • Maintain the inverter SN list. • You can click Synchronize to synchronize the transformer station number and winding number of the MBUS module to the inverters in the SN list. <p>NOTICE</p> <ul style="list-style-type: none"> • If MBUS networking is used, an SN list, that is, a whitelist, must be set for inverters. • The inverter whitelist can be set one by one or in batches. <ul style="list-style-type: none"> • One by one: Click Add, enter the SN of the corresponding inverter, and click Submit. • In batches: <p>Method 1: If the whitelist is set for the first time, click Template, download the .zip package to the local PC, decompress it, and enter the SNs of multiple inverters in the .csv file by referring to the format of the template. Click Import to import the modified .csv file, and then click Submit.</p> <p>Method 2: If the whitelist is not set for the first time, click Export, download the .zip package to the local PC, decompress it, and add the SNs of multiple inverters to the .csv file based on the format of the exported .csv file. Click Import to import the modified .csv file, and then click Submit.</p>
<p>Note [1]: This parameter can be set only in SmartMBUS V100R001C00SPC212 and later versions.</p> <p>Note [2]: This parameter can be set only in SmartMBUS V100R001C00SPC212 and later versions, but has been deleted in SmartMBUS V100R001C00SPC220 and later versions.</p> <p>Note [3]: This parameter can be set only in SmartMBUS V100R001C00SPC220 and later versions.</p>		

6.3.8.2 Setting Parameters for an External MBUS Module

Set parameters for an external MBUS module based on the model of the connected device. The models of external MBUS modules include SmartMBUS CCO01A and SmartMBUS CCO01B.

6.3.8.2.1 Setting SmartMBUS CCO01A Parameters

Procedure

1. Set access parameters.
 - **Method 1:** Click **Auto. Search** to connect to the MBUS module.
 - **Method 2:** Click **Add Devices**, set access parameters, and click **Add Devices**.

Figure 6-43 Setting access parameters for an external MBUS module

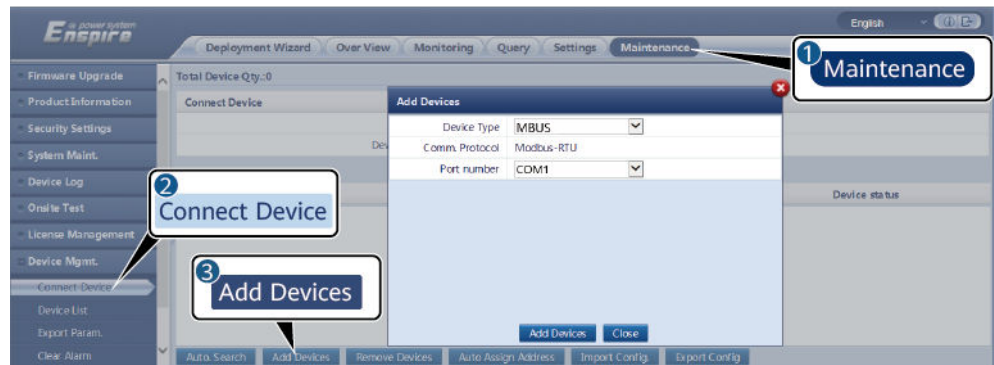

IL03J00013

Parameter	Description
Device Type	Set this parameter to MBUS .
Port number	Set this parameter to the COM port connected to the MBUS module.

2. Set networking parameters.

Figure 6-44 Setting external MBUS networking

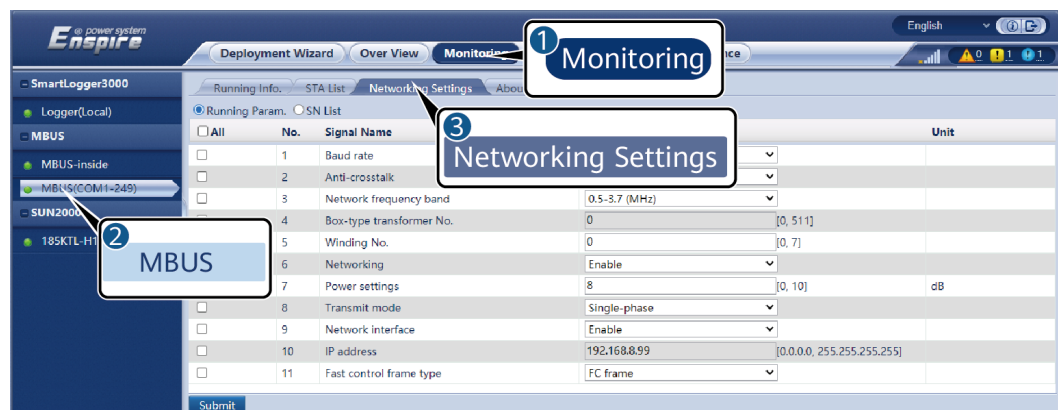

Tab	Parameter	Description
Running Param.	Baud rate	Retain the default value 115200 to achieve better communication performance.
	Anti-crosstalk	Set this parameter to Enable . When the transformer station number and winding number of the inverter are the same as those of the MBUS, or the inverter SN is in the SN list, the inverter can connect to the SmartLogger over an MBUS network.
	Network frequency band	Set this parameter based on site requirements.
	Box-type transformer No.	Set this parameter based on the number of the transformer station connected to the SmartLogger.
	Winding No.	In the scenario of multi-split transformer stations, set this parameter based on the winding number of the transformer station connected to the SmartLogger.
	Networking	<ul style="list-style-type: none"> When the SmartLogger communicates with the inverter over MBUS, set Networking to Enable. When the SmartLogger communicates with the inverter only over RS485, set Networking to Disable.
	Power settings	This parameter is used to adjust the transmit power of MBUS signals. A larger value indicates higher transmit power and better networking capabilities. The default value is 8 (NA is displayed). You can set this parameter based on actual requirements.
	Transmit mode ^[1]	<ul style="list-style-type: none"> Set this parameter to Single-phase in the rapid power grid scheduling scenario and to Three-phase in other scenarios. If this parameter is set to Single-phase, ensure that the MBUS three-phase AC power cable connection of the SmartLogger is the same as that of the inverter. Otherwise, the inverter communication may be disconnected or some commands may be lost.

Tab	Parameter	Description
	Network interface ^[1]	<ul style="list-style-type: none"> This parameter is used to enable communication between the MBUS module and the SmartLogger network interface. The default value is Disable. Set this parameter to Enable only in the power grid fast scheduling scenario. Ensure that the LAN interface on the SmartLogger or SmartModule is connected to the network interface on the MBUS module.
	IP address ^[1]	IP address of the MBUS module. The default value is 192.168.8.249 . Change the value only when an IP address conflict occurs.
	Fast control frame type ^[2]	<ul style="list-style-type: none"> This parameter specifies the frame type used by the MBUS module for rapid power grid scheduling. The MBUS module adaptively selects FC frame or Common frame.
	Fast scheduling ^[3]	<p>Set this parameter based on the actual networking.</p> <ul style="list-style-type: none"> If the fast scheduling function is required, set this parameter to Enable. If the fast scheduling function is not required, set this parameter to Disable.

Tab	Parameter	Description
SN List	-	<ul style="list-style-type: none"> • Maintain the inverter SN list. • You can click Synchronize to synchronize the transformer station number and winding number of the MBUS module to the inverters in the SN list. <p>NOTICE</p> <ul style="list-style-type: none"> • If MBUS networking is used, an SN list, that is, a whitelist, must be set for inverters. • The inverter whitelist can be set one by one or in batches. <ul style="list-style-type: none"> • One by one: Click Add, enter the SN of the corresponding inverter, and click Submit. • In batches: <p>Method 1: If the whitelist is set for the first time, click Template, download the .zip package to the local PC, decompress it, and enter the SNs of multiple inverters in the .csv file by referring to the format of the template. Click Import to import the modified .csv file, and then click Submit.</p> <p>Method 2: If the whitelist is not set for the first time, click Export, download the .zip package to the local PC, decompress it, and add the SNs of multiple inverters to the .csv file based on the format of the exported .csv file. Click Import to import the modified .csv file, and then click Submit.</p>
<p>Note [1]: This parameter can be set only in SmartMBUS V100R001C00SPC212 and later versions.</p> <p>Note [2]: This parameter can be set only in SmartMBUS V100R001C00SPC212 and later versions, but has been deleted in SmartMBUS V100R001C00SPC220 and later versions.</p> <p>Note [3]: This parameter can be set only in SmartMBUS V100R001C00SPC220 and later versions.</p>		

6.3.8.2.2 Setting SmartMBUS CCO01B Parameters

The SmartLogger3000 software versions of V300R023C00SPC110 and later support FE access.

Procedure

- (Optional) If the SmartMBUS CCO01B is installed in the STS, set **Built-in MBUS** to **Disable** on the SmartLogger3000, as shown in **Figure 6-45**. If the SACU model is SmartACU2000D-D-02 or SmartACU2000D-D-03, remove the power supply to disable the CCO module installed in the SACU to prevent communications interference between the two CCO modules. If the preceding conditions are not met, skip this step.

Figure 6-45 Setting parameters for a built-in MBUS module



- Set access parameters.
 - If FE communication is selected for the SmartMBUS CCO01B, the SmartMBUS CCO01B is automatically added.
 - If RS485 communication is selected for the SmartMBUS CCO01B, you have two methods to add a device.

Method 1: Click **Auto Search** to connect to the MBUS module.

Method 2: Click **Add Devices**, set access parameters, and click **Add Devices**.

Figure 6-46 Setting access parameters for an external MBUS module

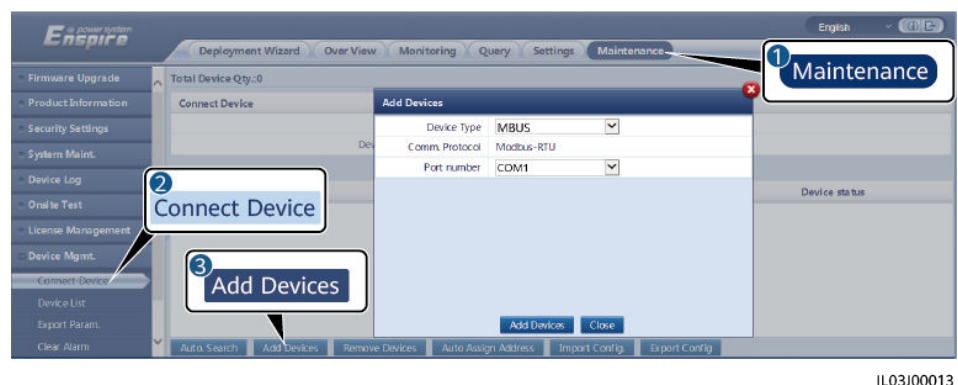

Parameter	Description
Device Type	Set this parameter to MBUS .
Port number	Set this parameter to the COM port connected to the MBUS module.

3. Set networking parameters.

Table 6-12 Setting parameters for external MBUS networking

Tab	Parameter	Description
Running Param.	Baud rate	Retain the default value 115200 to achieve better communication performance. This parameter is set only when the SmartMBUS CCO communication mode is set to RS485.
	Anti-crosstalk	Set this parameter to Enable . When the transformer station number and winding number of the inverter are the same as those of the MBUS, or the inverter SN is in the SN list, the inverter can connect to the SmartLogger over an MBUS network.
	Box-type transformer No.	Set this parameter based on the number of the transformer station connected to the SmartLogger.
	Winding No.	In the scenario of multi-split transformer stations, set this parameter based on the winding number of the transformer station connected to the SmartLogger.
	Networking	<ul style="list-style-type: none"> When the SmartLogger communicates with the inverter over MBUS, set Networking to Enable. When the SmartLogger communicates with the inverter only over RS485, set Networking to Disable.
	Power settings	This parameter is used to adjust the transmit power of MBUS signals. A larger value indicates higher transmit power and better networking capabilities. The default value is 8 (NA is displayed) . You can set this parameter based on actual requirements.

Tab	Parameter	Description
	Fast scheduling	<p>Set this parameter based on the actual networking.</p> <ul style="list-style-type: none"> • If the fast scheduling function is required, set this parameter to Enable. • If the fast scheduling function is not required, set this parameter to Disable.
	Network frequency band	<p>Retain the default value. If you have any questions, contact the supplier or technical support.</p>
SN List	-	<ul style="list-style-type: none"> • Maintain the inverter SN list. • You can click Synchronize to synchronize the transformer station number and winding number of the MBUS module to the inverters in the SN list. <p>NOTICE</p> <ul style="list-style-type: none"> • If MBUS networking is used, an SN list, that is, a whitelist, must be set for inverters. • The inverter whitelist can be set one by one or in batches. <ul style="list-style-type: none"> • One by one: Click Add, enter the SN of the corresponding inverter, and click Submit. • In batches: <p>Method 1: If the whitelist is set for the first time, click Template, download the .zip package to the local PC, decompress it, and enter the SNs of multiple inverters in the .csv file by referring to the format of the template. Click Import to import the modified .csv file, and then click Submit.</p> <p>Method 2: If the whitelist is not set for the first time, click Export, download the .zip package to the local PC, decompress it, and add the SNs of multiple inverters to the .csv file based on the format of the exported .csv file. Click Import to import the modified .csv file, and then click Submit.</p>

6.3.9 Setting Inverter Parameters

SUN2000 is displayed for V300R001C00.

Procedure

- Step 1** Choose **Maintenance > Connect Device** and set access parameters.
- **Method 1:** Click **Auto. Search** to connect to the solar inverter.
 - **Method 2:** Click **Add Devices**, set access parameters, and click **Add Devices**.

Figure 6-47 Setting access parameters

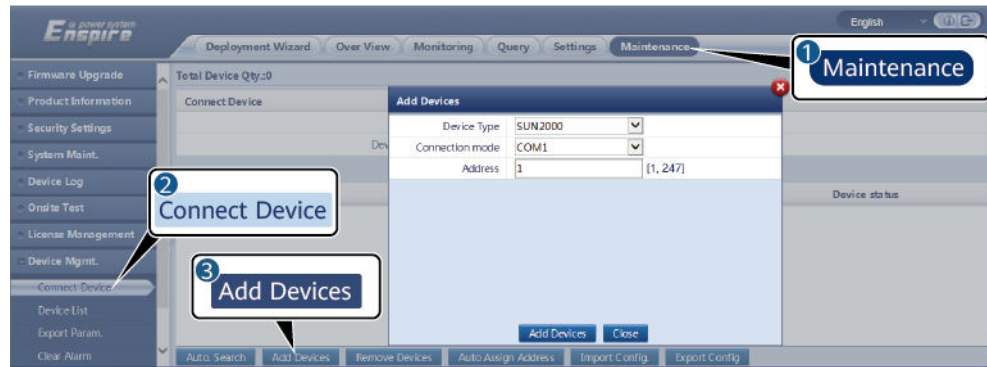

IL03J00015

Parameter	Description
Device type	Set this parameter to SUN2000 .
Connection mode	<ul style="list-style-type: none"> • If the solar inverter uses the MBUS for communication, set this parameter to MBUS. • If the solar inverter uses RS485 for communication, set this parameter to the COM port connected to the solar inverter.
Address	Set this parameter to the communication address of the solar inverter.

- Step 2** Choose **Monitoring > Inverter > Running Param.** and set running parameters, click **Submit**.

NOTICE

Before setting the running parameters of the solar inverter, ensure that the DC side of the solar inverter is energized.

----End

6.3.9.1 Running Parameters

Grid Parameters

Parameter	Description
Grid Code	Set this parameter based on the grid code of the country or region where the inverter is used and the inverter application scenario.
Isolation settings	Set the working mode of the inverter based on the grounding status at DC side and the connection to the power grid.
Output mode	Specifies whether the inverter output has a neutral wire based on the application scenario.
V-phase grounded	The default value is Disable . Set this parameter to Enable when the phase wire from the transformer to the inverter is grounded.
PQ mode	If this parameter is set to PQ mode 1 , the maximum AC output power equals the maximum apparent power. If this parameter is set to PQ mode 2 , the maximum AC output power equals the rated output power.
Automatically start upon grid recovery	Specifies whether to allow the inverter to automatically start after the power grid recovers. <ul style="list-style-type: none"> • Enable: The inverter automatically starts when the power grid recovers from a fault or outage. • Disable: The inverter does not automatically start when the power grid recovers from a fault or outage. The inverter starts only after a startup command is delivered.
Grid connected recovery time from grid faults (s)	Specifies the time after which the inverter begins restarting after the power grid recovers.
Grid reconnection voltage upper limit (V)	The standards of certain countries and regions require that after the inverter shuts down for protection due to a fault, if the power grid voltage is higher than Grid reconnection voltage upper limit , the inverter is not allowed to reconnect to the grid.
Grid reconnection voltage lower limit (V)	The standards of certain countries and regions require that after the inverter shuts down for protection due to a fault, if the power grid voltage is lower than Grid reconnection voltage lower limit , the inverter is not allowed to reconnect to the grid.
Grid reconnection frequency upper limit (Hz)	The standards of certain countries and regions require that after the inverter shuts down for protection due to a fault, if the power grid frequency is higher than Grid reconnection frequency upper limit , the inverter is not allowed to reconnect to the grid.
Grid reconnection frequency lower limit (Hz)	The standards of certain countries and regions require that after the inverter shuts down for protection due to a fault, if the power grid frequency is lower than Grid reconnection frequency lower limit , the inverter is not allowed to reconnect to the grid.

Parameter	Description
Reactive power compensation (cos ϕ -P) trigger voltage (%)	Specifies the voltage threshold for triggering reactive power compensation based on the cos ϕ -P curve.
Reactive power compensation (cos ϕ -P) exit voltage (%)	Specifies the voltage threshold for exiting reactive power compensation based on the cos ϕ -P curve.

Protection Parameters

Parameter	Description
Insulation resistance protection threshold (M Ω)	To ensure device safety, the inverter detects the insulation resistance of the input side with respect to ground when it starts a self-check. If the detected value is less than the preset value, the inverter does not connect to the grid.
Voltage unbalance protection threshold (%)	Specifies the inverter protection threshold when the power grid voltage is unbalanced.
Phase protection point ($^{\circ}$)	The Japanese standard requires that during passive islanding detection, protection should be triggered if an abrupt voltage phase change is detected.
Phase angle offset protection	The standards of certain countries and regions require that the inverter needs to be protected when the phase angle offset of the power grid three phases exceeds a certain value.
10-min overvoltage protection threshold (V)	Specifies the 10-minute overvoltage protection threshold.
10-min overvoltage protection duration (ms)	Specifies the 10-minute overvoltage protection duration.
Level-N OV protection (V)	Specifies the level-N grid overvoltage protection threshold.
Level-N OV protection time (ms)	Specifies the level-N grid overvoltage protection duration.
Level-N UV protection (V)	Specifies the level-N grid undervoltage protection threshold.
Level-N UV protection time (ms)	Specifies the level-N grid undervoltage protection duration.
Level-N OF protection (Hz)	Specifies the level-N grid overfrequency protection threshold.
Level-N OF protection time (ms)	Specifies the level-N grid overfrequency protection duration.
Level-N UF protection (Hz)	Specifies the level-N grid underfrequency protection threshold.
Level-N UF protection time (ms)	Specifies the level-N grid underfrequency protection duration.

 NOTE

N is 1, 2, 3, 4, 5, or 6.

Feature Parameters

Parameter	Description	Remarks
MPPT multi-peak scanning	When the inverter is used in scenarios where PV strings are greatly shaded, set this parameter to Enable , and then the inverter will perform MPPT scanning at regular intervals to locate the maximum power.	-
MPPT multi-peak scan interval (min)	Specifies the MPPT scanning interval.	This parameter is displayed when MPPT multi-peak scanning is set to Enable .
RCD enhancement	RCD refers to the residual current of the inverter to the ground. To ensure device and personal safety, RCD should be limited to the specified value in the standard. If an AC switch with a residual current detection function is installed outside the inverter, this function should be enabled to reduce the residual current generated when the inverter is running, thereby preventing the AC switch from misoperations.	-
Night-time reactive power output	In some specific application scenarios, a power grid company requires that the inverter can perform reactive power compensation at night to ensure that the power factor of the local power grid meets requirements.	This parameter is displayed when Isolation settings is set to Input ungrounded, with TF .
PID protection at night	When the inverter outputs reactive power at night and this parameter is set to Enable , the inverter will shut down automatically if it detects abnormal status of the PID compensation.	-
Strong adaptability	If the power grid short-circuit capacity or PV plant installed capacity is less than 3, the power grid quality will be affected if the power grid impedance is too high, which may cause the inverter to malfunction. In this case, if the inverter is required to work properly, set this parameter to Enable .	-
Power quality optimization mode	If this parameter is set to Enable , the inverter output current harmonics will be optimized.	-

Parameter	Description	Remarks
PV module type	This parameter is used to set different types of PV modules and the shutdown time of the concentration PV module. If the concentration PV modules are shaded, the power drops drastically to 0 and the inverter shuts down. The energy yield would be affected since it takes too long for the power to resume and inverter to restart. The parameter does not need to be set for crystalline silicon and filmy PV modules.	<ul style="list-style-type: none"> • If this parameter is set to Crystalline silicon or Film, the inverter automatically detects the power of PV modules when they are shaded and shuts down if the power is too low. • When concentration PV modules are used: <ul style="list-style-type: none"> - If this parameter is set to CPV 1, the inverter can quickly restart in 60 minutes if the input power of PV modules drops drastically due to shading. - If this parameter is set to CPV 2, the inverter can quickly restart in 10 minutes if the input power of PV modules drops drastically due to shading.
PID compensation direction	When the external PID module compensates the PID voltage for the PV system, set PID compensation direction to the actual compensation direction of the PID module so that the inverter can output reactive power at night.	PID compensation direction must be consistent with PV module compensation voltage direction of the PID module.
Built-in PID running mode	Specifies the operation mode of the inverter built-in PID.	-
PID nighttime off-grid repair	Specifies whether to enable the PID nighttime off-grid repair.	If PID running mode is not set to Disable , the parameter can be set.
PID daytime off-grid repair	Specifies whether to enable the PID daytime off-grid repair.	

Parameter	Description	Remarks
String connection mode	Specifies the connection mode of PV strings.	<ul style="list-style-type: none"> When PV strings connect to the inverter separately (All PV strings separated), there is no need to set this parameter. The inverter can automatically detect the connection mode of the PV strings. When PV strings connect to one another in parallel outside the inverter and then connect to it independently (All PV strings connected), set this parameter to All PV strings connected.
Automatic OFF due to communication interrupted	The standards of certain countries and regions require that the inverter must shut down after the communication is interrupted for a certain time.	If Automatic OFF due to communication interrupted is set to Enable and the inverter communication is interrupted for a specified time (set by Communication interruption duration), the inverter will automatically shut down.
Communication interruption duration (min)	Specifies the duration for determining communication interruption. Used for automatic shutdown for protection in case of communication interruption.	-
Automatic ON due to communication resumed	If this parameter is set to Enable , the inverter automatically starts after communication recovers. If this parameter is set to Disable , the inverter needs to be started manually after communication recovers.	This parameter is displayed when Automatic OFF due to communication interrupted is set to Enable .
Soft start/boot time (s)	Specifies the duration for the power to gradually increase when the inverter starts.	-
Shutdown gradient (%/s)	Specifies the power change speed when the inverter shuts down.	-
AFCI	The North American standard requires that the inverter should have DC arc detection function.	-
AFCI detection adaptive mode	Adjusts the sensitivity of arc detection.	This parameter is displayed only when AFCI is set to Enable .
AFCI self-test	Send the AFCI self-check command manually.	-

Parameter	Description	Remarks
Current error during the scan (A)	To prevent inaccurate scanning caused by sunlight change, the current change of PV strings operating properly should be monitored when the I-V curves of PV strings are being scanned. When the current exceeds the specified value, it is determined that the sunlight changes. The I-V curves should be scanned again.	-
OVGR associated shutdown	If this parameter is set to Enable , the inverter shuts down after receiving the OVGR signal. If this parameter is set to Disable , the inverter does not shut down after receiving the OVGR signal.	This parameter is displayed if the Japanese grid code is selected.
Dry contact function	Identifies the dry contact signals from the SmartLogger.	Set this parameter to OVGR for OVGR signals, and set it to NC for other signals. This parameter is displayed if the Japanese grid code is selected.
Commanded shutdown hold after power recovery	The standards of certain countries and regions require that if the inverter is shut down after receiving a command and powered on again after power recovers, it should still be in commanded shutdown state.	-
Night-time hibernation	The inverter monitors PV strings at night. If this parameter is set to Enable , the monitoring function of the inverter will hibernate at night to reduce power consumption.	-
MBUS communication	For inverters that support RS485 communication and MBUS communication, you are advised to set this parameter to Disable to reduce power consumption.	-
RS485-2 communication	If this parameter is set to Enable , the RS485-2 port can be used. If the port is not used, you are advised to set this parameter to Disable to reduce power consumption.	-
Delay upgrade	This parameter is mainly used in the upgrade scenarios where the PV power supply is disconnected at night due to no sunlight or unstable at dawn or dusk due to poor sunlight.	After the inverter starts to upgrade, if Delay upgrade is set to Enable , the upgrade package is loaded first. After the PV power supply recovers and the activation conditions are met, the inverter automatically activates the upgrade.

Parameter	Description	Remarks
String monitor	The inverter monitors PV strings in real time. If any PV string is abnormal (such as the PV string is shaded or the electric energy yield decreases), the inverter generates an alarm to remind maintenance personnel to maintain the PV string in a timely manner.	If PV strings are often shaded, you are advised to set String monitor to Disable to prevent false alarms.
String detection reference asymmetric coefficient	Specifies the threshold for determining PV string exception. The false alarms caused by fixed shadow shading can be controlled by changing this parameter.	This parameter is displayed when String monitor is set to Enable .
String detection starting power percentage (%)	Specifies the threshold for starting PV string exception detection. The false alarms caused by fixed shadow shading can be controlled by changing this parameter.	
OFF at 0% power limit	If this parameter is set to Enable , the inverter shuts down after receiving the 0% power limit command. If this parameter is set to Disable , the inverter does not shut down after receiving the 0% power limit command.	-
Maximum apparent power (kVA)	Specifies the output upper threshold for the maximum apparent power to adapt to the capacity requirements of standard and customized inverters.	If the maximum active power equals the value of Smax_limit, this parameter is not displayed.
Maximum active power (kW)	Specifies the output upper threshold for the maximum active power to adapt to different market requirements.	For 1000 V inverters, this parameter is configurable only for the SUN2000-25KTL-US, and the maximum value is 27.5 kW.
Tracker controller	Selects a controller vendor.	-
Adjust total energy yield (kWh)	Specifies the initial energy yield of the inverter. This parameter is used in inverter replacement scenarios. Set the initial energy yield of the new inverter to the total energy yield of the old inverter to ensure continuous statistics of cumulative energy yield.	-
Duration for determining short-time grid disconnection (ms)	The standards of certain countries and regions require that the inverter should not disconnect from the power grid if the power grid experiences a short-time failure. After the fault is rectified, the inverter output power needs to be quickly restored.	-

Parameter	Description	Remarks
Buzzer	If this parameter is set to Enable , the buzzer sounds when the DC input cable is incorrectly connected. If this parameter is set to Disable , the buzzer does not sound when the DC input cable is incorrectly connected.	-
LVRT	LVRT is short for low voltage ride-through. When the grid voltage is abnormally low for a short time, the inverter cannot disconnect from the power grid immediately and has to work for some time.	-
Threshold for triggering LVRT (V)	Specifies the threshold for triggering LVRT. The threshold settings should meet the local grid standard.	This parameter is displayed when LVRT is set to Enable .
LVRT compensation power factor of reactive power in positive sequence	<p>During LVRT, the solar inverter needs to generate positive-sequence reactive power to support the power grid. This parameter is used to set the positive-sequence reactive power generated by the solar inverter.</p> <p>For example, if you set LVRT compensation power factor of reactive power in positive sequence to 2, the increment of positive-sequence reactive current generated by the solar inverter is 20% of the rated current when the AC voltage decreases by 10% during LVRT. If you set LVRT compensation power factor of reactive power in positive sequence to 0, the increment of positive-sequence reactive current generated by the solar inverter is 0 regardless of how much the AC voltage decreases during LVRT.</p>	

Parameter	Description	Remarks
LVRT compensation power factor of reactive power in negative sequence	<p>During LVRT, the solar inverter needs to generate negative-sequence reactive power to support the power grid. This parameter is used to set the negative-sequence reactive power generated by the solar inverter.</p> <p>For example, if you set LVRT compensation power factor of reactive power in negative sequence to 2, the increment of negative-sequence reactive current generated by the solar inverter is 20% of the rated current when the AC voltage decreases by 10% during LVRT. If you set LVRT compensation power factor of reactive power in negative sequence to 0, the increment of negative-sequence reactive current generated by the solar inverter is 0 regardless of how much the AC voltage decreases during LVRT.</p>	
Percentage of LVRT reactive current limiting	<p>During LVRT, the device needs to limit the reactive current.</p> <p>For example, if you set Percentage of LVRT reactive current limiting to 50, the reactive current upper limit of the device is 50% of the rated current during LVRT.</p>	
Threshold of LVRT zero-current mode	<p>When Zero current due to power grid fault is set to Enable, if the power grid voltage is less than the value of Threshold of LVRT zero-current mode during LVRT, the zero current mode is used. Otherwise, the mode configured in LVRT mode is used.</p>	
LVRT mode	<p>Sets LVRT mode. The options are Zero-current mode, Constant current mode, Reactive power priority mode, and Active power priority mode.</p>	
HVRT	<p>HVRT is short for high voltage ride-through. When the grid voltage is abnormally high for a short time, the inverter cannot disconnect from the power grid immediately and has to work for some time.</p>	-
Threshold for triggering HVRT (V)	<p>Specifies the threshold for triggering HVRT. The threshold settings should meet the local grid standard.</p>	This parameter is displayed when HVRT is set to Enable .

Parameter	Description	Remarks
HVRT compensation power factor of reactive power in positive sequence	<p>During HVRT, the solar inverter needs to generate positive-sequence reactive power to support the power grid. This parameter is used to set the positive-sequence reactive power generated by the solar inverter.</p> <p>For example, if you set HVRT compensation power factor of reactive power in positive sequence to 2, the increment of positive-sequence reactive current generated by the solar inverter is 20% of the rated current when the AC voltage increases by 10% during HVRT.</p>	
LVRT undervoltage protection shield	Specifies whether to shield the undervoltage protection function during LVRT.	This parameter is displayed when LVRT is set to Enable .
Grid voltage protection shield during VRT	Specifies whether to shield the undervoltage protection function during LVRT or HVRT.	This parameter is displayed when LVRT or HVRT is set to Enable .
VRT active current limiting (%)	Specifies the percentage of the maximum active current to the rated current during fault ride-through (FRT).	-
VRT active power recovery gradient	Specifies the recovery rate when the active current recovers to the value at the moment before FRT.	-
Grid voltage jump triggering threshold (%)	Specifies the LVRT or HVRT threshold for triggering a transient voltage jump of a power grid. A transient voltage jump indicates that the inverter cannot immediately disconnect from the power grid when the power grid is abnormal due to transient changes.	This parameter is available when Grid code is set to VDE 4120 .
Zero current due to power grid fault	Certain countries and regions have requirements on the output current during high/low voltage ride-through. In this case, set this parameter to Enable . After this parameter is set to Enable , the output current is less than 10% of the rated current during high/low voltage ride-through.	This parameter is displayed when LVRT or HVRT is set to Enable .
Active islanding protection	Specifies whether to enable the active islanding protection function.	-
Passive islanding protection	Specifies whether to enable the passive islanding protection function.	This parameter is displayed if the Japanese grid code is selected.

Parameter	Description	Remarks
Voltage rise suppression	The standards of certain countries and regions require that when the output voltage exceeds a certain value, the inverter must suppress voltage rise by outputting reactive power and reducing active power.	-
Voltage rise suppressing reactive power adjustment point (%)	The standards of certain countries and regions require that the inverter generate a certain amount of reactive power when the output voltage exceeds a certain value.	<ul style="list-style-type: none"> This parameter is displayed when Voltage rise suppression is set to Enable. The value of Voltage rise suppressing active power derating point must be greater than that of Voltage rise suppressing reactive power adjustment point.
Voltage rise suppressing active power derating point (%)	The standards of certain countries and regions require that the active power of the inverter be derated according to a certain slope when the output voltage exceeds a certain value.	
Voltage rise suppression P-U curve	The standards of certain countries and regions require that the P-U curve be set.	This parameter is displayed when Voltage rise suppression is set to Enable .
Voltage rise suppression Q-U curve	The standards of certain countries and regions require that the Q-U curve be set.	
Frequency change rate protection	Set this parameter to Enable to protect the inverter when the grid frequency changes too fast.	-
Frequency change rate protection threshold (Hz/s)	Specifies the frequency change rate protection threshold.	This parameter is displayed if Frequency change rate protection is set to Enable .
Frequency change rate protection duration (s)	The inverter is protected when the grid frequency change duration exceeds the value.	
Soft start time after grid failure (s)	Specifies the time for the power to gradually increase when the inverter restarts after the power grid recovers.	-
CT anomaly detection	If this parameter is set to Enable , the inverter automatically checks whether CT cables are disconnected or connected in reverse polarity and reports an alarm to the SmartLogger.	-

Parameter	Description	Remarks
Churn mode	If this parameter is set to Enable , the Backup Box switches to this mode (off-grid mode) when the grid fails.	-
Reserved backup capacity	When Churn mode (off-grid mode) is set to Enable and the battery SOC reaches this value, the battery stops discharging to ensure that the SOC is above this value.	The association is displayed when Churn mode (off-grid mode) is set to Enable .
Grid-tied/Off-grid switching mode	If this parameter is set to Automatic , the system switches to the off-grid mode when the grid fails, and switches to the grid-tied mode when the grid recovers.	
Switch to off-grid	This parameter is displayed only when Grid-tied/Off-grid switching mode is set to Manual . To manually switch to off-grid mode, select the box on the left and click Submit .	
Voltage in independent operation	AC operating voltage level of the inverter in off-grid mode can be 101 V or 202 V .	
Microgrid compatibility	The default value is Disable . If the inverter and diesel generator run in parallel, set this parameter to Enable . When Microgrid compatibility is set to Enable , the grid-connected current source inverter supports a higher ratio of PV to energy storage in addition to the feature of the original country grid code.	

Power Adjustment Parameters

Parameter	Description	Remarks
Remote power schedule	If this parameter is set to Enable , the inverter responds to the scheduling instruction from the remote port. If this parameter is set to Disable , the inverter does not respond to the scheduling instruction from the remote port.	-
Schedule instruction valid duration (s)	Specifies the time for maintaining the scheduling instruction. When this parameter is set to 0, the scheduling instruction takes effect permanently.	When this parameter is set to 0, the scheduling instruction takes effect permanently.

Parameter	Description	Remarks
Maximum apparent power (kVA)	Specifies the output upper threshold for the maximum apparent power to adapt to the capacity requirements of standard and customized inverters.	If the maximum active power equals the value of Smax_limit, this parameter is not displayed.
Maximum active power (kW)	Specifies the output upper threshold for the maximum active power to adapt to different market requirements.	-
OFF at 0% power limit	If this parameter is set to Enable , the inverter shuts down after receiving the 0% power limit command. If this parameter is set to Disable , the inverter does not shut down after receiving the 0% power limit command.	-
Active power change gradient (%/s)	Specifies the change speed of the inverter active power.	-
Derated by fixed active power (kW)	Adjusts the active power output of the inverter by fixed value.	This parameter is displayed if Remote power schedule is set to Enable . For 1000 V inverters, the maximum value of this parameter for the SUN2000-25KTL-US is 27.5 kW.
Derated by active power % (%)	Adjusts the active power output of the inverter by percentage. If this parameter is set to 100 , the inverter outputs based on the maximum output power.	This parameter is displayed if Remote power schedule is set to Enable . If this parameter is set to 100 , the inverter outputs based on the maximum output power.
Reactive power change gradient (%/s)	Specifies the change speed of the inverter reactive power.	-
Plant active power gradient (min/100%)	Specifies the rate of active power rise due to sunlight changes.	-
Average active power filtering time (ms)	Specifies the period of active power rise due to sunlight changes. This parameter is used with Plant active power gradient .	-
PF (U) voltage detection filtering time (s)	Specifies the time for filtering the grid voltage in the PF-U curve.	-
Reactive power adjustment time (s)	Specifies the adjustment time for the reactive power to reach the target value during reactive power adjustment.	-

Parameter	Description	Remarks
Power factor	Specifies the power factor of the inverter.	This parameter is displayed if Remote power schedule is set to Enable .
Reactive power compensation (Q/S)	Specifies the reactive power output by the inverter.	
Night-time reactive power compensation (Q/S)	During the reactive power compensation at night, the reactive power is scheduled by percentage.	-
Night-time reactive power output	In some specific application scenarios, a power grid company requires that the inverter can perform reactive power compensation at night to ensure that the power factor of the local power grid meets requirements.	This parameter is displayed when Isolation settings is set to Input ungrounded, with TF .
Enable reactive power parameters at night	When this parameter is set to Enable , the inverter outputs reactive power based on the setting of Reactive power compensation at night . Otherwise, the inverter executes the remote scheduling command.	This parameter is displayed when Night-time reactive power output is set to Enable .
Night-time reactive power compensation (kVar)	During the reactive power compensation at night, the reactive power is scheduled by fixed value.	This parameter is displayed when Night-time reactive power output and Enable reactive power parameters at night are set to Enable .
Overfrequency derating	If this parameter is set to Enable , the active power of the inverter will be derated according to a certain slope when the grid frequency exceeds the frequency that triggers overfrequency derating.	-
Frequency for triggering overfrequency derating (Hz)	The standards of certain countries and regions require that the output active power of inverters be derated when the power grid frequency exceeds a certain value.	<ul style="list-style-type: none"> • This parameter is displayed when Overfrequency derating is set to Enable. • When setting this parameter, ensure that the following condition is met: Frequency for exiting overfrequency derating ≤ Frequency for triggering overfrequency derating < Cutoff frequency of overfrequency derating.
Frequency for exiting overfrequency derating (Hz)	Specifies the frequency threshold for exiting overfrequency derating.	
Cutoff frequency of overfrequency derating (Hz)	Specifies the frequency threshold for cutting off overfrequency derating.	

Parameter	Description	Remarks
Cutoff power of overfrequency derating (%)	Specifies the power threshold for cutting off overfrequency derating.	
Frequency detection filtering time (ms)	Specifies the frequency detection filter time.	
Overfrequency derating power drop gradient (%/s)	Specifies the decrease rate of the overfrequency derating power.	
Power recovery gradient of overfrequency derating (%/min)	Specifies the recovery rate of the overfrequency derating power.	
Voltage derating	If this parameter is set to Enable , the active power of the inverter will be derated according to a certain slope when the grid voltage exceeds the voltage that triggers overfrequency derating.	-
Voltage derating start point (V)	Specifies the start point for voltage derating.	<ul style="list-style-type: none"> • This parameter is displayed when Voltage derating is set to Enable. • When setting this parameter, ensure that the following condition is met: Voltage derating start point < Voltage derating stop point.
Cut-off point of voltage derating (V)	Specifies the stop point for voltage derating.	
Voltage derating cut-off power (V)	Specifies the power threshold for cutting off voltage derating.	
Communication disconnection fail-safe	In the inverter export limitation scenario, if this parameter is set to Enable , the inverter will perform active power derating by percentage when the communication between the inverter and the SmartLogger or Smart Dongle is disconnected for more than the time specified by Communication disconnection detection time .	N/A
Communication disconnection detection time (s)	Specifies the fail-safe detection time for the disconnection between the inverter and the SmartLogger or Smart Dongle.	This parameter is displayed when Communication disconnection fail-safe is set to Enable .
Active power output limit for fail-safe (%)	Specifies the derating value of the inverter active power by percentage.	
Apparent power baseline (kVA)	Adjusts the apparent output baseline of the inverter.	-

Parameter	Description	Remarks
Active power baseline (kW)	Adjusts the active output baseline of the inverter.	-
Frequency modulation control	The standards of certain countries and regions require that if the power grid frequency fluctuates around a certain value, the inverter needs to fine-tune the active power output based on Frequency modulation control droop to help stabilize the power grid frequency. In this case, set this parameter to Enable	-
Adjustment ratio of frequency modulation control	Specifies the droop of the active power output.	This parameter is displayed when Frequency modulation control is set to Enable .
Underfrequency rise power	The standards of certain countries and regions require that if the power grid frequency is lower than Frequency for triggering of underfrequency rise power , the inverter needs to increase the active power output to help increase the power grid frequency. In this case, set this parameter to Enable .	-
Frequency for triggering of underfrequency rise power (Hz)	Specifies the frequency threshold of Underfrequency rise power .	This parameter is displayed when Underfrequency rise power is set to Enable .
Power recovery gradient of underfrequency rise (%/min)	Specifies the recovery rate of Underfrequency rise power .	
Cutoff frequency of underfrequency rise power (Hz)	Specifies the cutoff frequency of Underfrequency rise power .	
Cutoff power of underfrequency rise power (%)	Specifies the cutoff power of Underfrequency rise power .	
Frequency for exiting of underfrequency rise power (Hz)	Specifies the exit frequency of Underfrequency rise power .	

PV String Access Detection

- PV string access detection applies to large-scale commercial ground PV plants with PV strings facing the same direction.

- In AC or DC power limiting scenarios:
 - If the PV string access type has not been identified, **PV string N access status** will be displayed as **Disconnection**. The PV string access type can be identified only when the solar inverters restore to the non-power limiting state and the current of all connected PV strings reaches the **startup current**.
 - If the PV string access type has been identified, when a certain PV string connected to the 2-in-1 terminals is lost, no alarm will be generated. If a certain PV string connected to the 2-in-1 terminals is restored, the access type cannot be identified. You can determine whether both 2-in-1 PV strings are restored only when the PV string current reaches **Startup current for 2-in-1 detection**.
- After setting the parameters, you can go to the **Running Info.** tab page to check whether the PV string connection status is normal.

Table 6-13 Parameter description

Parameter	Parameter Description
PV String Access Detection	PV String Access Detection is set to Disable by default. After solar inverters are connected to the power grid, set PV String Access Detection to Enable .
Startup current	When the current of all connected PV strings reaches the preset value, the PV string access detection function is enabled. NOTE Startup current setting rules: <ul style="list-style-type: none"> • Startup current = $I_{sc}(S_{tc}) \times 0.6$ (rounded up). For details about $I_{sc}(S_{tc})$, see the PV module nameplate. • Default startup current (5 A): applicable to the scenarios where the short-circuit current $I_{sc}(S_{tc})$ is greater than 8 A for the monocrystalline and polycrystalline PV modules.
Startup current for 2-in-1 detection	When the current of a PV string reaches Startup current for 2-in-1 detection , the PV string is automatically identified as 2-in-1 . You are advised to retain the default settings.
PV string N access type NOTE N is the DC input terminal number of the solar inverter.	Set this parameter based on the type of the PV string connected to DC input terminal <i>N</i> of the solar inverter. Currently, the options are as follows: Automatic identification (default value), Disconnection, Single PV string, and 2-in-1. You are advised to retain the default value. If the value is incorrectly set, the PV string access type may be incorrectly identified and alarms may be generated by mistake for the PV string access status.

6.3.9.2 Tracking System

- The web software versions corresponding to the WebUI screenshots in this document are V300R001C00SPC050. The screenshots are for reference only.
- If a PV string uses a tracking system with a controller, set tracking system parameters on the **Tracking System** tab page.

Procedure

1. Before setting the tracking system parameters, you need to set **Tracker Controller** in **Feature Parameters** on the **Running Param.** tab page. Select the corresponding vendor based on the information about the tracker controller. If the vendor is not in the list, select **Other vendors**.

NOTE

This section uses **Other vendors** as an example.

Figure 6-48 Setting tracking system controller

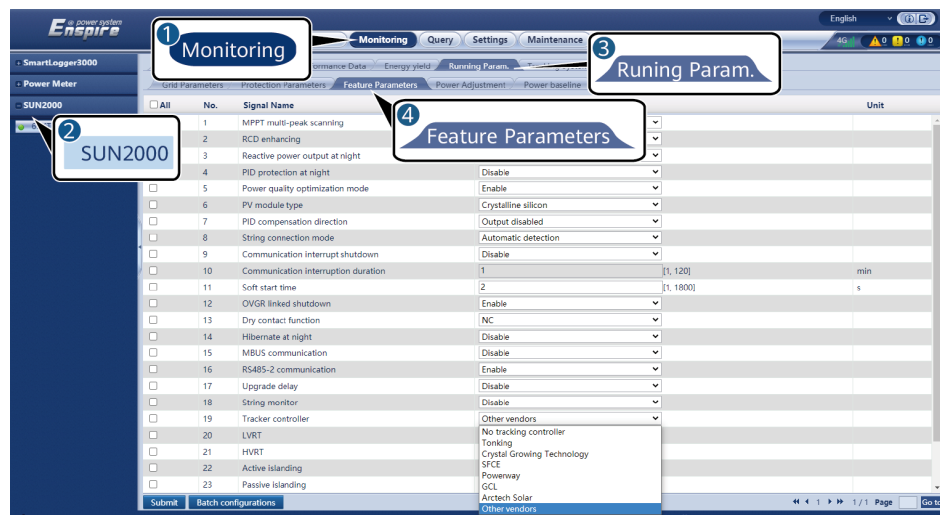

2. On the **Tracking System** tab page, select **Config Para.**

Figure 6-49 Setting configuration parameters (tracking system)

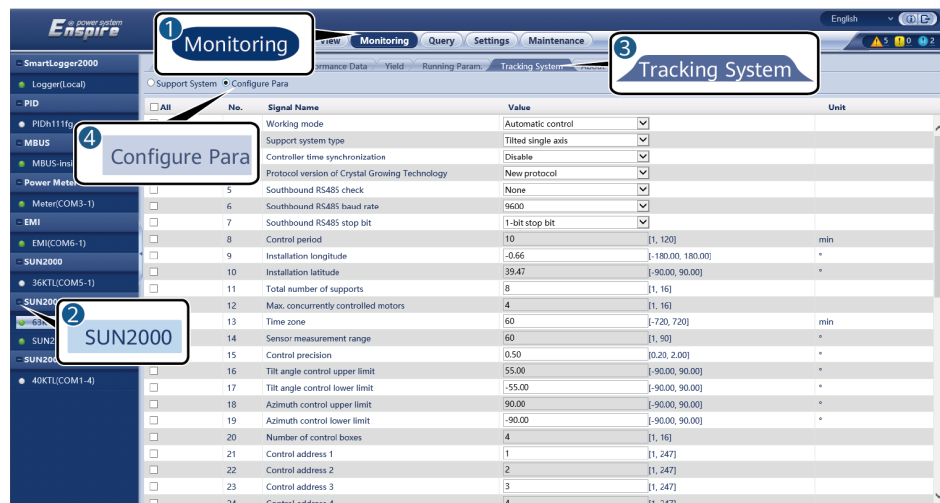

Parameter	Description
Working mode	Six working modes are supported: Automatic control, Manual control, Maintenance mode, Wind mode, Snow mode, and Rain mode. Set Working mode based on the actual operating status of the inverter.
Support system type	Four types of support systems are supported: Tilted single axis, Horizontal single axis, Vertical single axis, and Dual axis. NOTE The support system type can be set only when Tonking or Crystal Growing Technology is selected. For other vendors, the support system type is automatically selected based on the inverter configuration.
Controller time synchronization	This parameter can be set to Enable or Disable . After this parameter is set to Enable , the time is synchronized with the tracking system every 15 minutes.
Protocol version of Crystal Growing Technology	When Crystal Growing Technology is selected, you can set this parameter to New protocol or Old protocol based on the site requirements.
Southbound RS485 check	This parameter can be set to None, Odd parity, and Even parity.
Southbound RS485 baud rate	This parameter can be set to 4800, 9600, 19200, or 115200.
Southbound RS485 stop bit	This parameter can be set to 1-bit stop bit and 2-bit stop bit.
Control period	When Tonking is selected, you can set the period for refreshing the target angle.
Installation longitude	The longitude and latitude can be set.
Installation latitude	
Total number of supports	The inverter obtains the number of supports under each control box based on the configured number and addresses of the control boxes, and calculates and obtains the total number of supports. NOTE This parameter can be set only when Tonking or Crystal Growing Technology is selected.
Max. concurrently controlled motors	When Tonking is selected, this parameter can be set.
Time zone	The time zone can be set.
Sensor measurement range	When Tonking is selected, this parameter can be set.

Parameter	Description
Control precision	When Tonking is selected, this parameter can be set.
Tilt angle control upper limit	These parameters can be set only when Work mode is set to Manual control .
Tilt angle control lower limit	
Azimuth control upper limit	
Azimuth control lower limit	
Number of control boxes	Set this parameter based on the number of control boxes connected to the inverter. NOTE This parameter can be set only when Other vendor is selected.
Control address 1-16	Set this parameter based on the communication address of the control box. NOTE This parameter can be set only when Other vendor is selected.

- On the **Tracking System** tab page, click **Support System** and check **Total number of supports** and check whether **Access Status** and **System Status** are normal.

NOTE

- Check whether the value of **Total number of supports** is the same as that in **Config Para**.
- If **Working mode** in **Config Para** is set to **Manual control**, you can manually set parameters such as **Starting**, **Stop**, **Clr Fault**, and **Azimuth** in **Support System**.

Figure 6-50 Support system (tracking system)

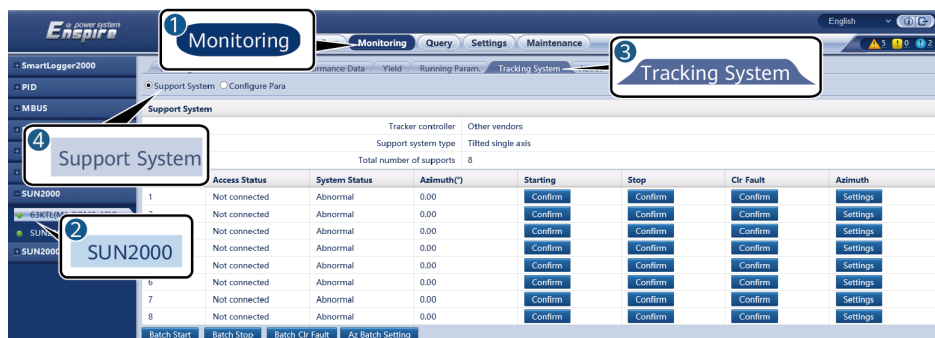

6.3.9.3 Characteristic Curves

The web software versions corresponding to the WebUI screenshots in this document are V300R001C00SPC050. The screenshots are for reference only.

Step 1 Set characteristic curve parameters and click **Submit**.

Figure 6-51 Characteristic curves

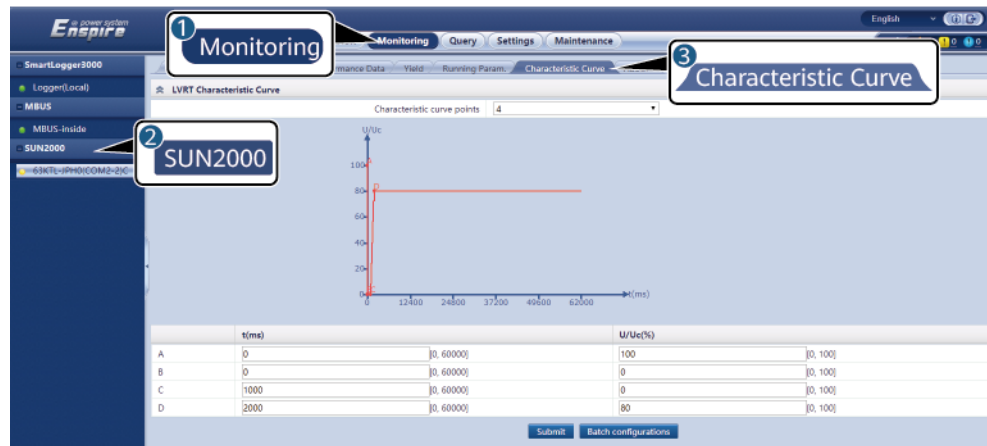

IL04J00026

Characteristic Curve Name	Description
LVRT Characteristic Curve	Configure this characteristic curve based on the power grid standard. NOTE The SmartLogger supports only the 60-second LVRT characteristic curve configuration. If the power grid standard requires that the duration of LVRT be greater than 60s, LVRT Characteristic Curve is not displayed for the grid code.
[Voltage Rise Suppression]Q-U curve	1. Set Voltage Rise Suppression to Enable . 2. Configure this characteristic curve based on the power grid standard.
[Voltage Rise Suppression]P-U curve	1. Set Voltage Rise Suppression to Enable . 2. Configure this characteristic curve based on the power grid standard.

----End

6.3.9.4 Battery

This section describes how to query or set battery parameters when the inverter is connected to a battery.

Battery Information

Parameter	Description
Working status	Indicates the current working status of the battery, which can be Offline , Idle , Running , Faulty , or Hibernating .
Working mode	Indicates the current working mode of the inverter battery control.
Charge/Discharge power	Total charge and discharge power of all batteries connected to the inverter.
SOC	Indicates the power status of all batteries connected to the inverter.
Bus voltage	Indicates the voltage on the DC bus of the battery.
Bus current	Indicates the current on the DC bus of the battery.
Rated capacity	Total rated capacity of all batteries connected to the inverter. The rated capacity refers to the total amount of energy discharged by the batteries in normal conditions.
Current-day charge capacity	Total energy charged into the batteries on the current day.
Current-day discharge capacity	Total energy discharged from the batteries on the current day.
Total charge	Total energy charged into the batteries.
Total discharge	Total energy discharged from the batteries.

Energy Storage Unit

Parameter	Description
Firmware version	Software version of the DC/DC module.
SN	Serial number of the DC/DC module.
Working status	Indicates the current working status of the energy storage unit, which can be Offline , Idle , Running , Faulty , or Hibernating .
Rated capacity	Total amount of energy discharged by the energy storage unit in normal conditions.
Voltage	Voltage of the energy storage unit.
Current	Current of the energy storage unit.

Parameter		Description
Internal temperature		Temperature inside the energy storage unit.
SOC		Indicates the power status of the energy storage unit.
Charge/Discharge power		Indicates the charge or discharge power of the energy storage unit.
Current-day charge capacity		Total energy charged into the energy storage unit on the current day.
Current-day discharge capacity		Total energy discharged from the energy storage unit on the current day.
Total charge		Total energy charged into the energy storage unit.
Total discharge		Total energy discharged from the energy storage unit.
Battery model		Models of the energy storage unit, including LG-RESU and LUNA2000 .
Battery pack	Firmware version	Software version of the battery pack.
	SN	Serial number of the battery pack.
	Working status	Indicates the current working status of the battery pack, which can be Offline , Idle , Running , Faulty , or Hibernating .
	Voltage	Voltage of the battery pack.
	Charge/Discharge power	Indicates the charge or discharge power of the energy storage unit.
	Highest temperature	Indicates the highest temperature detected in the battery pack.
	Lowest temperature	Indicates the lowest temperature detected in the battery pack.
	SOC	Power status of the battery pack.
	Total discharge	Total energy discharged from the battery pack.

Configurable Parameters

Parameter	Description
Energy Storage Unit	Displays or sets the battery model. The system automatically identifies and displays the correct model. Generally, you do not need to manually modify the information.
Maximum charge power	Sets the maximum power for battery charging.
Maximum discharge power	Sets the maximum power for battery discharging.
Charge from AC	If this parameter is set to Enable , the batteries can be charged from the power grid.
Maximum charge power of grid	Sets the maximum power for charging the batteries from the power grid.
Charge cutoff capacity	When the SOC of the battery reaches this value, charging stops.
Max. depth of discharge	When the SOC of the battery reaches this value, discharging stops.
Grid charge cutoff SOC	When the SOC of the battery reaches this value, the grid stops charging the battery.

Charge/Discharge

Parameter	Description
Charge/Discharge	Forced charge/discharge operation, which can be Charge , Discharge , or Stop .
Mode Settings	To enter the forced charge/discharge mode, set Duration or Target SOC .
Duration	Sets the duration of forced charge/discharge. When the time is reached, the forced charge/discharge stops automatically. This parameter is displayed when Mode Settings is set to Duration .
Charged energy	Sets the target SOC for forced charge/discharge. When the SOC reaches this value, the forced charge/discharge stops automatically. This parameter is displayed when Mode Settings is set to Target SOC .
Discharged energy	Current charged energy in this forced charge/discharge

6.3.10 Setting PCS Parameters

This section does not apply to V300R001C00.

Procedure

- Step 1** Choose **Monitoring > PCS > Running Param.** and set running parameters, click **Submit**.

NOTICE

Before setting the running parameters of the Smart PCS, ensure that the DC side is energized.

----End

6.3.10.1 Running Parameters

Grid Parameters

Parameter	Description
Grid code	Set this parameter based on the grid code of the country or region where the device is used.
Output mode	Specifies the supported power grid types.
Isolation settings	Specifies the device grounding status at DC side and the connection to the power grid.
Auto start upon grid recovery	Specifies whether to allow the device to automatically start after the power grid recovers.
On-grid recovery time (s)	Specifies the time after which the device begins restarting after the power grid recovers.
Quick startup for short-time grid disconnection	Specifies whether to allow the device to quickly start after the power grid recovers from a short-time failure.
Duration for determining short-time grid disconnection (ms)	The standards of certain countries and regions require that the device should not disconnect from the power grid if the power grid experiences a short-time failure. After the fault is rectified, the device output power needs to be quickly restored.
Soft start time after grid failure (s)	Specifies the time for the power to gradually increase when the device restarts after the power grid recovers.
Upper voltage threshold (V) for grid connection	According to the standards of certain countries and regions, initial grid connection is not allowed when the grid voltage is higher than the maximum voltage for grid connection.

Parameter	Description
Lower voltage threshold (V) for grid connection	According to the standards of certain countries and regions, initial grid connection is not allowed when the grid voltage is below the minimum voltage for grid connection.
Upper frequency threshold (Hz) for grid connection	According to the standards of certain countries and regions, initial grid connection is not allowed when the grid frequency is higher than the maximum frequency for grid connection.
Lower frequency threshold (Hz) for grid connection	According to the standards of certain countries and regions, initial grid connection is not allowed when the grid frequency is below the minimum frequency for grid connection.
Grid reconnection voltage upper limit (V)	According to the standards of certain countries and regions, grid reconnection is not allowed when the grid voltage is higher than the maximum voltage for grid reconnection.
Grid reconnection voltage lower limit (V)	According to the standards of certain countries and regions, grid reconnection is not allowed when the grid voltage is below the minimum grid voltage for grid reconnection.
Grid reconnection frequency upper limit (Hz)	According to the standards of certain countries and regions, grid reconnection is not allowed when the grid frequency is higher than the maximum grid frequency for grid reconnection.
Grid reconnection frequency lower limit (Hz)	According to the standards of certain countries and regions, grid reconnection is not allowed when the grid frequency is below the minimum grid frequency for grid reconnection.
Grid automatic reconnection time	Specifies the time after which the device begins restarting after the power grid recovers.

Protection Parameters

Parameter	Description
Insulation resistance protection threshold (MΩ)	To ensure device safety, the device detects the insulation resistance of the DC side to the ground when it starts a self-check. If the detected value is less than the preset value, the device does not connect to the grid nor start.
Active islanding protection	Specifies whether to enable the active islanding protection function.
Passive islanding protection	Specifies whether to enable the passive islanding protection function.
Unbalance voltage protection (%)	Specifies the device protection threshold when the power grid voltage is unbalanced.
Phase protection threshold (°)	The Japanese standard requires that during passive islanding detection, the protection should be triggered if an abrupt voltage phase change is detected.

Parameter	Description
Phase angle offset protection	The standards of certain countries and regions require that the device needs to be protected when the phase angle offset of the power grid three phases exceeds a certain value.
10-minute UV protection	Specifies the 10-minute undervoltage protection threshold.
10-minute UV protection time	Specifies the 10-minute undervoltage protection duration.
10 minute OV protection (V)	Specifies the 10-minute overvoltage protection threshold.
10 minute OV protection time (ms)	Specifies the 10-minute overvoltage protection duration.
Level-N OV protection (V)	Specifies the level-N grid overvoltage protection threshold.
Level-N OV protection time (ms)	Specifies the level-N grid overvoltage protection duration.
Level-N UV protection (V)	Specifies the level-N grid undervoltage protection threshold.
Level-N UV protection time (ms)	Specifies the level-N grid undervoltage protection duration.
Frequency change rate protection	If this parameter is set to Enable , the device is protected when the power grid frequency changes too fast.
Frequency change rate threshold (Hz/s)	Specifies the frequency change rate protection threshold.
Duration threshold (s) for frequency change rate protection	The device is protected when the grid frequency change duration exceeds the value.
Level-N OF protection (Hz)	Specifies the level-N grid overfrequency protection threshold.
Level-N OF protection time (ms)	Specifies the level-N grid overfrequency protection duration.
Level-N UF protection (Hz)	Specifies the level-N grid underfrequency protection threshold.
Level-N UF protection time (ms)	Specifies the level-N grid underfrequency protection duration.

 **NOTE**

N can be 1, 2, 3, 4, 5, or 6.

Feature Parameters

Parameter	Description	Remarks
Communication interruption duration	Specifies the duration for determining communication interruption between the device and the SmartLogger.	-
Shutdown on communication failure	The standards of certain countries and regions require that the device shut down after the communication is interrupted for a certain time.	If this parameter is set to Enable , the device automatically shuts down after the Communication interruption duration is reached.
Automatic startup upon communication recovery	If this parameter is set to Enable , the device automatically starts after communication recovers. If this parameter is set to Disable , the device needs to be started manually after communication recovers.	This parameter is displayed when the Shutdown on communication failure is set to Enable .
Protection in the case of communication failure	In reverse current prevention scenarios, if this parameter is set to Enable , the device performs active power percentage derating when the communication between the device and the SmartLogger or Smart Dongle is interrupted for a period longer than Communication disconnection detection time . The device performs protection according to the set power.	-
Communication disconnection detection time (s)	Specifies the fail-safe detection time for the disconnection between the device and the SmartLogger or Smart Dongle.	This parameter is displayed when the Protection in the case of communication failure is set to Enable .
Active power mode when communication fails	Specifies the protection threshold of the active power after the communication is interrupted. The value can be a percentage or a fixed value.	This parameter is displayed when the Protection in the case of communication failure is set to Enable .
Active power limit when communication fails (%)	Specifies the active power threshold in percentage.	This parameter is displayed when the Protection in the case of communication failure is set to Enable and Active power threshold when communication fails is set to a percentage.

Parameter	Description	Remarks
Active power limit when communication fails (kW)	Specifies the active power threshold as a fixed value.	This parameter is displayed when the Protection in the case of communication failure is set to Enable and Active power threshold when communication fails is set to a fixed value.
Reactive power mode when communication fails	Specifies the protection threshold of the reactive power after the communication is interrupted, including Q/S and power factor.	This parameter is displayed when the Protection in the case of communication failure is set to Enable .
Reactive power limit when communication fails (%)	Specifies the Q/S threshold of the reactive power (%).	This parameter is displayed when Protection in the case of communication failure is set to Enable and Reactive power mode when communication fails is set to Power factor .
Reactive power limit when communication fails	Specifies the power factor threshold of the reactive power.	This parameter is displayed when the Protection in the case of communication failure is set to Enable and Reactive power mode when communication fails is set to Q/S .
Soft start time (s)	Specifies the duration for the power to gradually increase when the device starts.	-
Shutdown gradient (%/s)	Specifies the power change rate when the device shuts down.	-
Shutdown at 0% power limit	If this parameter is set to Enable , the device shuts down after receiving the 0% power limit command. If this parameter is set to Disable , the device does not shut down after receiving the 0% power limit command.	-
Hibernate at night	The device performs the monitoring function at night. If this parameter is set to Enable , the monitoring function of the device will hibernate at night to reduce power consumption.	-

Parameter	Description	Remarks
Delayed upgrade	This parameter is mainly used in the upgrade scenarios where the power supply at DC side is disconnected.	After the upgrade starts, if Delayed upgrade is set to Enable , the upgrade package is loaded first. After the DC side power supply recovers and the activation conditions are met, the device automatically activates the upgrade.
HVRT	HVRT is short for high voltage ride-through. When the grid voltage is abnormally high for a short time, the device cannot disconnect from the power grid immediately and has to work for some time.	-
HVRT threshold (V)	Specifies the threshold for triggering HVRT. The threshold settings should meet the local grid standard.	This parameter is displayed when HVRT is set to Enable .
Positive-sequence reactive power compensation factor in HVRT	During HVRT, the device needs to generate positive-sequence reactive power to support the power grid. This parameter is used to set the positive-sequence reactive power generated by the device. For example, if you set this parameter to 2 , the increment of positive-sequence reactive current generated by the device is 20% of the rated current when the AC voltage increases by 10% during HVRT.	
Negative-sequence reactive power compensation factor in HVRT	During HVRT, the device needs to generate negative-sequence reactive power to support the power grid. This parameter is used to set the negative-sequence reactive power generated by the device. For example, if you set this parameter to 2 , the increment of negative-sequence reactive current generated by the device is 20% of the rated current when the AC voltage increases by 10% during HVRT.	
LVRT	LVRT is short for low voltage ride-through. When the grid voltage is abnormally low for a short time, the device cannot disconnect from the power grid immediately and has to work for some time.	-
LVRT threshold (V)	Specifies the threshold for triggering LVRT. The threshold settings should meet the local grid standard.	This parameter is displayed when LVRT is set to Enable .

Parameter	Description	Remarks
Positive-sequence reactive power compensation factor in LVRT	<p>During LVRT, the device needs to generate positive-sequence reactive power to support the power grid. This parameter is used to set the positive-sequence reactive power generated by the device.</p> <p>For example, if you set this parameter to 2, the increment of positive-sequence reactive current generated by the device is 20% of the rated current when the AC voltage decreases by 10% during LVRT.</p>	
Negative-sequence reactive power compensation factor in LVRT	<p>During LVRT, the device needs to generate negative-sequence reactive power to support the power grid. This parameter is used to set the negative-sequence reactive power generated by the device.</p> <p>For example, if you set this parameter to 2, the increment of negative-sequence reactive current generated by the device is 20% of the rated current when the AC voltage decreases by 10% during LVRT.</p>	
LVRT active current maintenance coefficient	Specifies the active current proportional coefficient before and during LVRT.	
Percentage of LVRT reactive current limiting	<p>During LVRT, the device needs to limit the reactive current.</p> <p>For example, if you set Percentage of LVRT reactive current limiting to 50, the reactive current upper limit of the device is 50% of the rated current during LVRT.</p>	
Threshold of LVRT zero-current mode	When Zero current due to power grid fault is set to Enable , if the power grid voltage is less than the value of Threshold of LVRT zero-current mode during LVRT, the zero current mode is used. Otherwise, the mode configured in LVRT mode is used.	
LVRT mode	Sets LVRT mode. The options are Zero-current mode , Constant current mode , Reactive power priority mode , and Active power priority mode .	
LVRT characteristic curve	Specifies the low voltage ride-through capability of the device.	-
Deactivate grid voltage protection during HVRT/ LVRT	Specifies whether to shield the undervoltage protection function during LVRT or HVRT.	This parameter is displayed when LVRT or HVRT is set to Enable .

Parameter	Description	Remarks
VRT exit hysteresis threshold	Specifies the LVRT/HVRT recovery threshold.	<ul style="list-style-type: none"> This parameter is displayed when LVRT or HVRT is set to Enable. LVRT recovery threshold = LVRT threshold + VRT exit hysteresis threshold HVRT recovery threshold = HVRT threshold - VRT exit hysteresis threshold
VRT active current limiting (%)	Specifies the percentage of the maximum active current to the rated current during fault ride-through (FRT).	-
VRT active power recovery gradient	Specifies the recovery rate when the active current recovers to the value at the moment before FRT.	-
Zero current due to power grid fault	Specifies whether to enable the Zero current due to power grid fault function.	-
Grid voltage jump triggering threshold	This parameter can be set only for the VDE4120.	-
Voltage rise suppression	The standards of certain countries and regions require that when the output voltage exceeds a certain value, the device must suppress voltage rise by outputting reactive power and reducing active power.	-
Reactive power adjustment threshold (%) for voltage rise suppression	The standards of certain countries and regions require that the device generate a certain amount of reactive power when the output voltage exceeds a certain value.	<ul style="list-style-type: none"> This parameter is displayed when Voltage rise suppression is set to Enable. The value of Voltage rise suppression active derating point must be greater than that of Reactive power adjustment threshold for voltage rise suppression.

Parameter	Description	Remarks
Active power derating threshold (%) for voltage rise suppression	The standards of certain countries and regions require that the active power of the device be derated by a certain slope when the output voltage exceeds a certain value.	-
P-U characteristic curve	The device adjusts P/Pn (the ratio of the active power to the rated power) in real time based on U/Un(%) (the ratio of the actual power grid voltage to the rated power grid voltage).	-
P-U characteristic curve adjustment time	Specifies the time from the response to the end of the adjustment based on the P-U curve.	-
Frequency regulation	The standards of certain countries and regions require that if the power grid frequency fluctuates around a certain value, the device needs to fine-tune the active power output based on the frequency regulation ratio to help stabilize the power grid frequency. In this case, set this parameter to Enable .	-
Adjustment ratio of frequency modulation control	Specifies the adjustment ratio of the active power output.	This parameter is displayed when the Frequency regulation is set to Enable .
Response deadband of frequency-based control	Specifies the threshold for triggering the frequency modulation control. For example, if this parameter is set to 0.1 Hz, the frequency modulation control is not triggered when the frequency is within reference frequency \pm 0.1 Hz.	-
Power change gradient of frequency-based control	Specifies the active power change gradient of frequency modulation.	-
Power change limit of frequency-based control	Specifies the upper limit for active power adjustment of frequency modulation.	-
Delay response time of frequency-based control	Specifies the delay response time of frequency modulation.	-

Parameter	Description	Remarks
Power derating caused by overfrequency	If this parameter is set to Enable , the active power of the device will be derated according to a certain slope when the grid frequency exceeds the frequency that triggers overfrequency derating.	-
Cutoff frequency of overfrequency derating (Hz)	Specifies the frequency threshold for cutting off overfrequency derating.	<ul style="list-style-type: none"> This parameter is displayed when the Power derating caused by overfrequency is set to Enable. The parameter setting should meet the following condition: Quit frequency of overfrequency derating \leq Trigger frequency of overfrequency derating $<$ Cutoff frequency of overfrequency derating.
Cutoff power of overfrequency derating (%)	Specifies the power threshold for cutting off overfrequency-caused derating.	
Trigger frequency of overfrequency derating (Hz)	The standards of certain countries and regions require that the output active power of devices be derated when the power grid frequency exceeds a certain value.	
Quit frequency of overfrequency derating (Hz)	Specifies the frequency threshold for exiting overfrequency derating.	
Power drop gradient of overfrequency derating (%/s)	Specifies the decrease rate of the overfrequency derating power.	
Power recovery gradient of overfrequency derating (%/min)	Specifies the recovery rate of the overfrequency derating power.	
Frequency detection filter time (ms)	Specifies the frequency detection filter time.	
Recovery delay of frequency-based active power derating	Specifies the exiting delay time after the frequency reaches the quit frequency of overfrequency derating.	-
Execution delay of frequency-based active power derating	Specifies the effective delay time of overfrequency derating when the frequency reaches the trigger frequency of overfrequency derating.	-
Hysteresis of frequency-based active power derating	Specifies whether to enable overfrequency derating hysteresis.	-

Parameter	Description	Remarks
Power raising caused by underfrequency	The standards of certain countries and regions require that when the power grid frequency is lower than Trigger frequency of underfrequency rise power , the device needs to increase the active power output to help increase the power grid frequency. In this case, set this parameter to Enable .	-
Recovery gradient of underfrequency rise power (%/min)	Specifies the power recovery rate of underfrequency-caused raising.	This parameter is displayed when the Power raising caused by underfrequency is set to Enable .
Cutoff frequency of underfrequency rise power (Hz)	Specifies the frequency threshold for stopping underfrequency-caused raising.	
Cutoff power of underfrequency rise power (%)	Specifies the cutoff power of the power raising caused by underfrequency.	
Trigger frequency of underfrequency rise power (Hz)	Specifies the frequency threshold for underfrequency-caused power raising.	
Quit frequency of underfrequency rise power (Hz)	Specifies the quit frequency of the power raising caused by underfrequency.	
O&M via USB connection	Specifies the USB O&M port status: Permanently Enabled , Disabled in Idle State , or Permanently Disabled .	
USB wakeup	Used to remotely wake up the USB O&M port. After being idle for 4 hours, the port is automatically disabled.	-
Quick startup for short-time grid disconnection	The default value is Disable . Specifies whether to allow the device to quickly start after the power grid recovers from a short-time failure.	-
Microgrid compatibility	The default value is Disable . If the PCS and diesel generator run in parallel and the PCS works in PQ mode, set this parameter to Enable . When Microgrid compatibility is set to Enable , the grid-connected current source PCS supports a higher ratio of PV to energy storage in addition to the feature of the original country grid code.	If this parameter is set incorrectly, the Smart PCS may run abnormally.

Parameter	Description	Remarks
Working mode	The default value is PQ . You need to set the working mode during deployment. Set Working mode to VSG in off-grid scenarios and PQ in grid-tied scenarios.	After this parameter is set, the device shuts down.
Per unit armature resistance	The default value is 2 . Specifies the resistance per unit value for armature windings of the virtual synchronous generator.	This parameter is displayed when Working mode is set to VSG . NOTE This parameter must be set by professional personnel. Improper settings may cause device exceptions.
Per unit armature inductive reactance	The default value is 1 . Specifies the inductive reactance per unit value for armature windings of the virtual synchronous generator.	
VSG inertia time constant	The default value is 1 . Specifies the time required for the virtual rotor of the virtual synchronous generator to reach the rated speed from the static state under the rated torque.	
P-F adjustment coefficient	The default value is 1 . Specifies the frequency deviation corresponding to the rated active power of the virtual synchronous generator.	
Q-V adjustment coefficient	The default value is 3 . Specifies the voltage deviation corresponding to the rated reactive power of the virtual synchronous generator.	
P-V adjustment coefficient	The default value is 0 . Specifies the voltage deviation corresponding to the rated active power of the virtual synchronous generator.	
Q-F adjustment coefficient	The default value is 0 . Specifies the frequency deviation corresponding to the rated reactive power of the virtual synchronous generator.	
VSG output voltage correction coefficient	The default value is 100 . Corrects the deviation caused by the transformer ratio error.	
VSG output frequency correction coefficient	The default value is 100 . Corrects the PCS output frequency deviation.	
VSG frequency damping coefficient	The default value is 7.2 . Specifies the power factor that prevents the frequency change of the virtual synchronous generator.	
VSG excitation time constant	The default value is 0 . Specifies the time required for the excitation of the virtual synchronous generator to reach the rated voltage.	

Parameter	Description	Remarks
VSG excitation damping coefficient	The default value is 0 . Specifies the power factor that prevents the voltage change of the virtual synchronous generator.	
Wired carrier synchronization	Enables or disables wired carrier synchronization. The default value is Disable .	-
Delay compensation for wired carrier synchronization	The default value is 0 . Specifies the value of delay compensation for wired carrier synchronization.	This parameter is displayed when Wired carrier synchronization is set to Enable .
Wired power frequency synchronization	Enables or disables wired power frequency synchronization. The default value is Disable .	-
Delay compensation for wired power frequency synchronization	The default value is 0 . Specifies the value of delay compensation for wired power frequency synchronization.	This parameter is displayed when Wired power frequency synchronization is set to Enable .
Voltage adjustment value for VSG synchronous control (%)	The default value is 0 . Specifies the adjustment value of the PCS control output voltage in VSG mode.	<ul style="list-style-type: none"> Value range: [-10.0, 10.0] The value is adjusted based on the offset per unit value. For example, if the rated output voltage is 800 V and the output voltage needs to be adjusted to 805 V, the adjustment value is $5/800 \times 100\%$.
Frequency adjustment value for VSG synchronous control (%)	The default value is 0 . Specifies the adjustment value of the PCS output frequency in VSG mode.	<ul style="list-style-type: none"> Value range: [-10.0, 10.0] The value is adjusted based on the offset per unit value. For example, if the rated output frequency is 50 Hz and the output frequency needs to be adjusted to 50.5 Hz, the adjustment value is $0.5/50 \times 100\%$.
Scenario ^[1]	Specifies the on-grid/off-grid scenario. The default value is On-grid.	Before submitting new settings, you need to enter the login password for authentication.

Parameter	Description	Remarks
Harmonic Optimization Type ^[1]	Specifies harmonic voltage or harmonic current as the object of power quality optimization. The default value is Harmonic voltage.	Before submitting new settings, you need to enter the login password for authentication.
Auto switching between working modes ^[1]	The default value is Disable . Disable: On/Off-grid switching can be performed and the PCS must be shut down before the switching. Enable: On/Off-grid switching can be performed automatically and the PCS does not need to be shut down before the switching.	-
Working mode switching delay ^[1]	Time for other commands to take effect during PCS working mode switching. The default value is 60 . The value of this parameter ranges from 10s to 300s.	-
Note [1]: This parameter can be set only in SmartLogger V300R023C10 and later versions.		

Power Adjustment Parameters

Parameter	Description	Remarks
Remote power scheduling	If this parameter is set to Enable , the device responds to the scheduling instruction from the remote port. If this parameter is set to Disable , the device does not respond to the scheduling instruction from the remote port.	-
Schedule instruction valid duration (s)	Specifies the validity period of the scheduling instruction.	When this parameter is set to 0, the scheduling instruction takes effect permanently.
Active power change gradient (%/s)	Specifies the change rate of the device active power.	This parameter is displayed when Remote power scheduling is set to Enable .
Active power (kW)	Adjusts the active power output of the device by fixed value.	
Active power (%)	Adjusts the active power output of the device by percentage.	
Reactive power change gradient (%/s)	Specifies the change rate of the device reactive power.	
Power factor	Specifies the power factor of the device.	

Parameter	Description	Remarks
Reactive power compensation (Q/S)	Specifies the reactive power of the device.	
Reactive power at night	In some specific application scenarios, a power grid company requires that the device can perform reactive power compensation at night to ensure that the power factor of the local power grid meets requirements.	This parameter is displayed when Isolation is set to Input ungrounded (with TF) .
Enable reactive power parameters at night	When this parameter is set to Enable , the device outputs reactive power based on the setting of Reactive power output at night . Otherwise, the device executes the remote scheduling command.	This parameter is displayed when Reactive power at night is set to Enable .
Fixed nighttime reactive power	The device outputs reactive power based on this value if there is no remote scheduling command, Reactive power at night is set to Enable , and the DC input is disconnected.	-
Q-U characteristic curve	The device adjusts Q/S (the ratio of the output reactive power to apparent power) in real time based on U/Un(%) (the ratio of the actual power grid voltage to the rated power grid voltage).	-
Q-U characteristic curve mode	Specifies the reactive power compensation mode of the device output.	-
Delay for Q-U characteristic curve to take effect	Specifies the delay time for Q-U adjustment.	-
Power percentage for triggering Q-U scheduling	Specifies the reference apparent power in percentage. When the actual apparent power of the device is greater than the value of this parameter, the Q-U characteristic curve scheduling function is enabled.	-
Power percentage for exiting Q-U scheduling	Specifies the P/Pn when the device exits the Q-U scheduling.	-
Minimum PF of Q-U characteristic curve	Specifies the minimum power factor for Q-U adjustment.	-

Parameter	Description	Remarks
Q-P characteristic curve	The device adjusts Q/Pmax (the ratio of the reactive power to the maximum active power) in real time based on P/Pmax (the ratio of the active power to the maximum active power).	-
PF-U characteristic curve	The device adjusts the power factor in real time based on U/Un(%) (the ratio of the actual power grid voltage to the rated power grid voltage).	-
PF-U voltage detection filter time	Specifies the time for filtering the grid voltage in the PF-U curve.	-
cosφ-P/Pn characteristic curve	The device adjusts the output power factor cosφ in real time based on P/Pn(%).	-
cosφ-P/Pn triggering voltage	Specifies the voltage threshold for triggering reactive power compensation based on the cosφ-P curve.	-
cosφ-P/Pn exit voltage	Specifies the voltage threshold for exiting reactive power compensation based on the cosφ-P curve.	-
Reactive power adjustment time	Specifies the adjustment time for the reactive power to reach the target value during reactive power adjustment.	-
Active Power Frequency Regulation Coefficient in Grid Forming Mode	Specifies the preset frequency of the frequency regulation deadband.	-
Reactive Power Voltage Regulation Deadband in Grid Forming Mode	Specifies the preset voltage of the voltage regulation deadband.	-
Active Power Frequency Regulation Coefficient in Grid Forming Mode	Specifies the ratio of the per unit value of the active power variation to the per unit value of the frequency variation for the frequency regulation. Value range: [0.0, 200.0].	-

Parameter	Description	Remarks
Reactive Power Voltage Regulation Coefficient in Grid Forming Mode	Specifies the ratio of the per unit value of the reactive power variation to the per unit value of the root mean square voltage variation for the voltage regulation. Value range: [0.0, 50.0].	-
Maximum Reactive Power Increase for Voltage Regulation in Grid Forming Mode	Specifies maximum percentage of the reactive power variation for the voltage regulation. The upper limit can be set to three times the per unit value of Apparent Power Baseline . Value range: [0.0, 300.0].	-
Maximum Active Power Increase for Frequency Regulation in Grid Forming Mode	Specifies the maximum percentage of the active power variation for the frequency regulation. The upper limit can be set to the per unit value of Active Power Baseline . Value range: [0.0, 100.0].	-

Reference Power Parameters

Parameter	Setting Description
Apparent power baseline	Set the apparent power baseline for power scheduling. The value cannot be greater than the maximum apparent power.
Active power baseline	Set the active power baseline for power scheduling. The value cannot be greater than the maximum active power.

Calibrating the Energy Yield

Parameter	Setting Description
Total energy yield adjustment	A calibrating coefficient for the total energy yield to ensure that the reported energy yield is consistent with the actual energy yield at the grid-connection point
Adjustment of total power supply from grid	A calibrating coefficient for the total power supply from the grid to ensure that the reported energy yield is consistent with the actual power supply from grid

6.3.10.2 Characteristic Curve

Step 1 Choose **Monitoring > PCS > Characteristic Curve**, set characteristic curve parameters, and click **Submit**.

Characteristic Curve Name	Setting Description
LVRT characteristic curve	Configure this characteristic curve based on the power grid standard. NOTE The SmartLogger supports only the curve configuration for LVRT that lasts no more than 60s. If a power grid standard requires that LVRT be longer than 60s, LVRT characteristic curve is not displayed for the grid code.
Voltage rise suppression P-U curve	<ol style="list-style-type: none"> 1. This parameter is displayed when Voltage rise suppression is set to Enable. 2. Configure this characteristic curve based on the power grid standard.

----End

6.3.11 Setting CMU Parameters

This section does not apply to V300R001C00.

Procedure

Choose **Monitoring > ESS > CMU > Running Param.**, set running parameters, and click **Submit**.

Temperature and Humidity Control

Parameter	Description
Control mode	<ul style="list-style-type: none"> • Auto (default): The operating status and mode of the air conditioner are automatically controlled by the temperature and humidity control module. • Manual: You can manually set the operating status and mode of the air conditioner for commissioning. After the commissioning is complete, switch back to the automatic mode. Otherwise, the temperature and humidity may be out of control.
Air conditioner parameter setting ^[1]	<ul style="list-style-type: none"> • Default: The air conditioner works based on the default cooling start/stop temperatures and heating start/stop temperatures in the system software. • Custom: You can adjust the cooling start/stop temperatures and heating start/stop temperatures of the air conditioner as required.
Forced dehumidification control	At the first startup after deployment or long-term storage, you are advised to start forced dehumidification to reduce the risk of equipment damage caused by condensation.
Note [1]: This parameter can be set only in V300R023C00 and later versions.	

Exhaust Control

Parameter	Description
Exhaust fan control module self-test time	Time when the exhaust function is self-tested every day
Exhaust fan control module self-test	After the self-test is started, the exhaust fan will be running for a period of time to check its exhaust function. If the exhaust fan does not meet the requirements, the system cannot start.
Exhaust fan control	After started, the exhaust fan will automatically stop in at least 1 hour. If a combustible gas alarm is generated, the exhaust fan cannot be stopped. The exhaust fan cannot be manually started after the fire response is triggered until the fire alarm is cleared or 24 hours later.

Fire Suppression

NOTE

Only the LUNA2000-2.0MWH series Smart String ESS supports DC output power distribution.

Parameter	Description
DC output distribution	<ul style="list-style-type: none"> • Starting up: Enable the DC output power distribution to supply 48 V DC power to the battery pack fan, BMU, and ESC monitoring system. • Stop: Disable the DC output power distribution to stop supplying 48 V DC power to the battery pack fan, BMU, and ESC monitoring system.

NOTE

Only the LUNA2000-200KWH series Smart String ESS supports the temperature alarm threshold settings.

Parameter	Description
Temperature alarm threshold	Specifies the temperature threshold for triggering a fire alarm and processing fire response logic.

Burglar Alarm

The burglar alarm function applies only to the C&I scenario. This function is supported only in SmartLogger V300R023C00SPC172 and later versions and shall be used together with LUNA2000B V100R023C00SPC120 and later versions.

Parameter	Description
Burglar Alarm	<p>The default value is Disable.</p> <p>Disable: No burglar alarm will be triggered when the ESS door is open.</p> <p>Enable: A burglar alarm will be triggered when the ESS door is open.</p>

6.3.12 Setting ESU Parameters

This section does not apply to V300R001C00.

Procedure

Choose **Monitoring > ESS > ESU > Running Param.**, set running parameters, and click **Submit**.

Running Parameters

Parameter	Description
Enable delayed update	<ul style="list-style-type: none"> The default value is Enable. When delayed upgrade is set, after the upgrade package is uploaded, the ESU will perform the upgrade automatically when the SOC is greater than or equal to 30%, the rack voltage is greater than or equal to 400 V, and the ESC and ESM communicate properly. If this parameter is set to Disable, the upgrade can be performed immediately. The upgrade may fail if the upgrade conditions are not met.
Delete invalid battery packs	Delete battery packs that are not connected. This function is used when replacing battery packs.
Battery pack shutdown delay	After this parameter is set, the system can still monitor the battery for a period of time after power-off.
Shutdown due to communication interruption between the rack controller and PCS	<ul style="list-style-type: none"> The default value is Disable. If this parameter is set to Enable, the ESS shuts down when the communication between the PCS and the rack controller is interrupted.

6.3.13 Setting ESC Parameters

This section does not apply to V300R001C00.

Procedure

Choose **Monitoring > ESS > ESU > ESC > Running Param.**, set running parameters and click **Submit**.

Running Parameters

Parameter	Setting Description
Insulation resistance protection threshold	To ensure device safety, the device detects the insulation resistance of the DC side to the ground when it starts a self-check. If the detected value is less than the preset value, the device does not start.

6.3.14 Setting ESR Parameters

This section does not apply to V300R001C00.

Procedure

Choose **Monitoring > ESS > ESU > ESR > Running Param.**, set running parameters and click **Submit**.

Parameters Settings

Parameter	Setting Description
Battery working mode	Set the battery to Running or Hibernation .
Charging cutoff SOC	Set the charging stop threshold of battery modules in a battery rack.
Discharge cutoff SOC	Set the discharging stop threshold of battery modules in a battery rack.
Quantity of battery packs	Set the quantity of battery packs in a battery rack. If the number is inconsistent with the actual number, the system cannot start.
Insulation resistance diagnosis	Action or stop the detection for power insulation resistance of the battery rack.
Battery pack position detection	Start or stop the identification for battery pack positions in a battery rack.

Energy Yield Calibration

Parameter	Setting Description
Total charged energy calibration	Calibrate the total charged energy.
Total discharged energy calibration	Calibrate the total discharged energy.

6.3.15 Setting HVAC Parameters

This section does not apply to V300R001C00.

Procedure

Choose **Monitoring > ESS > HVAC > Running Param.**, set running parameters and click **Submit**.

Parameters Settings

Parameter	Setting Description
Working mode	<p>The default value is Auto. The air conditioner working mode can be Auto, Dry, Heat, or Cool.</p> <p>CAUTION</p> <ul style="list-style-type: none"> The working mode of the air conditioner is adjusted intelligently. Non-professional personnel are not allowed to set the running mode. The air conditioner dehumidification mode is used for system protection. Do not set the air conditioner to dehumidification mode manually. The heating and cooling modes of the air conditioner are used only for equipment commissioning. Do not set them manually.
Refrigeration start temperature	<p>Set the target temperature for cooling when the air conditioner works in automatic mode.</p> <p>CAUTION This parameter affects the system charge/discharge power and cell lifespan. Non-professional personnel are not allowed to set this parameter.</p>
Refrigeration stop temperature	<p>Specifies the target temperature when the air conditioner stops cooling in automatic mode.</p> <p>CAUTION This parameter affects the system charge/discharge power and cell lifespan. Non-professional personnel are not allowed to set this parameter.</p>
Heating start temperature	<p>Set the target temperature for heating when the air conditioner works in automatic mode.</p> <p>CAUTION This parameter affects the system charge/discharge power and cell lifespan. Non-professional personnel are not allowed to set this parameter.</p>
Heating stop temperature	<p>Specifies the target temperature when the air conditioner stops heating in automatic mode.</p> <p>CAUTION This parameter affects the system charge/discharge power and cell lifespan. Non-professional personnel are not allowed to set this parameter.</p>
High temperature alarm threshold	<p>Set the indoor high temperature alarm threshold for the air conditioner.</p>
Low temperature alarm threshold	<p>Set the indoor low temperature alarm threshold for the air conditioner.</p>

Parameter	Setting Description
AC overvoltage alarm threshold	Set the upper threshold for the AC input voltage of the air conditioner. NOTE This parameter applies only to air conditioners in the battery cabin of the LUNA2000-2.0MWH Series Smart String ESS.
AC undervoltage alarm threshold	Set the lower threshold for the AC input voltage of the air conditioner. NOTE This parameter applies only to air conditioners in the battery cabin of the LUNA2000-2.0MWH Series Smart String ESS.
DC overvoltage alarm threshold	Set the upper threshold for the DC input voltage of the air conditioner. NOTE This parameter applies only to in-cabinet air conditioners of the LUNA2000-200KWH Series Smart String ESS and air conditioners in the control unit cabin of the LUNA2000-2.0MWH Series Smart String ESS.
DC undervoltage alarm threshold	Set the lower threshold for the DC input voltage of the air conditioner. NOTE This parameter applies only to in-cabinet air conditioners of the LUNA2000-200KWH Series Smart String ESS and air conditioners in the control unit cabin of the LUNA2000-2.0MWH Series Smart String ESS.

6.3.16 Setting PID Module Parameters

Procedure

1. Set access parameters.

Method 1: Click **Auto. Search** to connect to the PID module.

Method 2: Click **Add Devices**, set access parameters, and click **Add Devices**.

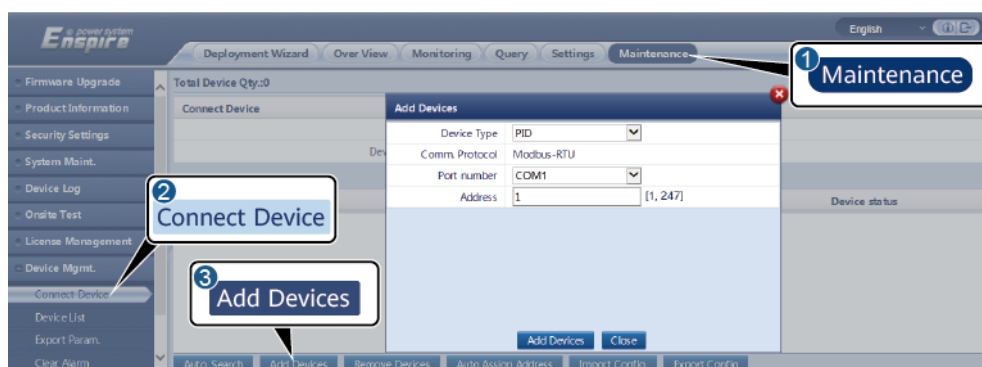

IL03J00017

Table 6-14 Device access parameters

Parameter	Description
Device Type	Set this parameter to PID .
Port number	<ul style="list-style-type: none"> If the PID-PVBOX uses MBUS for communication, set this parameter to MBUS. If the PID module uses RS485 for communication, set this parameter to the COM port connected to the PID module.
Address	Set this parameter to the communications address of the PID module.

2. (Optional) Apply for and load the PID license. Perform this step if you need to use the PID module to detect the ground insulation resistance. Otherwise, skip this step.
 - a. Choose **Maintenance > License Management > License application**, select the PID device for which a license is to be applied, click **Export License Appli File**, and purchase a license file from the supplier.
 - b. Choose **Maintenance > License Management > License loading**, click **Upload License**, select the PID device to which the license file is to be loaded, and click **Load License**.

NOTE

SmartPID2000 V100R001SPC112, SmartLogger V300R023C00SPC153, and later versions support the smart insulation monitoring function of the PID module. You can check the function in **Monitoring > PID > About**. If PN is **02350XQD-001**, the function is supported. Otherwise, the function is not supported.

3. Set running parameters and click **Submit**.

Figure 6-52 Setting running parameters

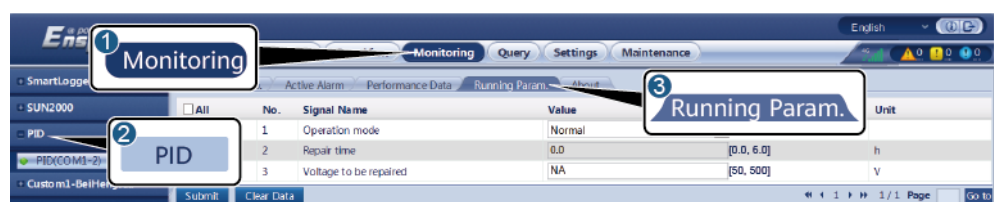

IL03J00018

Set PID module running parameters based on the model of the connected device. The PID device models include PID01 and SmartPID2000.

6.3.16.1 Setting PID01 Parameters

6.3.16.1.1 PID Module Running Parameters

NOTE

The parameter list provided in this document includes all configurable parameters. Configurable parameters vary depending on the device model. The actual display may vary.

Parameter	Description
Offset mode	<p>Specifies the offset mode of the PID module.</p> <ul style="list-style-type: none">• Select Disabled if the PID module is not required.• Select N/PE if the PID module is required to use voltage output from the inductor virtual midpoint.• Select PV/PE if the PID module is required to use voltage output from the negative PV terminal. This mode is applicable only to Huawei SUN8000.• In the SUN2000 scenario, Automatic indicates the N/PE offset mode.
Output enabled	<p>Specifies whether PID module output is enabled.</p>
PV module type	<p>Specifies the type of the PV module used in the power plant. For details about the PV module type, consult the manufacturer.</p>
PV/PE offset voltage	<p>Specifies the DC output voltage when the offset mode is set to PV/PE.</p> <ul style="list-style-type: none">• If the PV module type is P, set this parameter to P-type. In this case, the output voltage of the PID module is positive.• If the PV module type is N, set this parameter to N-type. In this case, the output voltage of the PID module is negative.
Operation Mode	<p>Specifies the working mode of the PID module.</p> <ul style="list-style-type: none">• Manual mode: If Offset mode is set to N/PE or PV/PE, and Output enabled is set to Enable, the PID module outputs data based on Output voltage (manual).• Automatic mode: After the PID module and inverter communicate with the SmartLogger properly, the PID module automatically runs. <p>NOTE</p> <ul style="list-style-type: none">• Before the first power-on, to check whether the PID functions properly, it is recommended that Operation Mode be set to Manual.• After checking that the PID module functions properly, set Operation Mode to Automatic.
Output voltage (manual)	<p>Specifies the output voltage.</p> <p>NOTE</p> <p>After this parameter is set and the output from the PID module becomes stable, use a multimeter that is set to the DC position to measure the three-phase (A, B, and C) voltages of the power grid to the ground, and check whether the voltages are the same as the configured values.</p>

Parameter	Description
Maximum DC voltage	<p>Specifies the PV-PE voltage when the normal operation mode is used.</p> <p>If the PV module type is P, the parameter value indicates the highest DC voltage between PV+ and PE. If the PV module type is N, the parameter value indicates the highest DC voltage between PV- and PE.</p>
Maximum output voltage	<p>Specifies the maximum output voltage of the PID module.</p> <p>If the offset mode is PV/PE, the parameter value indicates the highest DC output voltage between PV and PE. If the offset mode is N/PE, the parameter value indicates the highest DC output voltage between N and PE.</p>
IMD access	<p>Specifies whether the PID module and insulation monitor device (IMD) can operate in cycle mode.</p> <p>Only the IMDs of mainstream suppliers such as DOLD and BENDER are supported, and the IMDs must have enabled dry contacts.</p> <p>NOTICE You can set Periodic PID runtime, Periodic IMD runtime, and IMD control dry contact only when IMD access is set to Enable.</p>
Periodic PID runtime	<p>Specifies the running duration of the PID module when the PID module and IMD operate in cycle mode.</p> <p>The IMD is shut down when the PID module is operating.</p>
Periodic IMD runtime	<p>Specifies the running duration of the IMD when the PID module and IMD operate in cycle mode.</p> <p>The PID module is standby when the IMD is running.</p>
IMD control dry contact	<p>Specifies the dry contact No. over which the SmartLogger controls the IMD.</p> <p>Set appropriate ports based on the cable connections between the IMD and the SmartLogger.</p>

Parameter	Description
<p>PV module compensation voltage direction</p>	<p>Specifies the compensation direction of the PID module.</p> <ul style="list-style-type: none"> ● PV- po: The voltage between the PV- and the ground is increased to a value greater than 0 V through voltage compensation. Select PV- po for P-type PV modules or the N-type PV modules that comprise the cells whose positive and negative polarities are on different sides. For example, P-type PV modules, HIT, CIS, thin-film PV modules, and CdTe PV modules meet the requirement for PV- positive offset. ● PV+ ne: The voltage between the PV+ and the ground is decreased to lower than 0 V through voltage compensation. Select PV+ ne for the N-type PV modules that comprise the cells whose positive and negative polarities are on the same side. <p>NOTE When designing a PV plant, the design institute and user should confirm with the PV module vendor about the direction of voltage compensation for the anti-PID effect of PV modules.</p>
<p>Working mode</p>	<p>Specifies the working mode of the PID module.</p> <ul style="list-style-type: none"> ● Manual: The PID module provides output based on Output voltage (manual). ● Automatic mode: After the PID module and inverter communicate with the SmartLogger properly, the PID module automatically runs. <p>NOTE</p> <ul style="list-style-type: none"> ● Before the first power-on, to check whether the PID functions properly, it is recommended that Operation Mode be set to Manual. ● After checking that the PID module functions properly, set Operation Mode to Automatic.
<p>Maximum system DC-to-ground withstand voltage</p>	<p>Specifies the voltages between the PV side and the ground and between the AC side and the ground in normal mode.</p> <p>Specifies the lower threshold of the maximum voltage range between the inverter DC side (including the inverter, PV module, cable, SPD, and switch) and the ground.</p> <p>The default value is 1000 V. For a 1500 V inverter, the recommended value is 1500 V.</p>
<p>AC-to-ground resistance alarm threshold</p>	<p>Specifies the alarm threshold for the impedance between the AC side of the PID module and the ground.</p> <p>You can set an alarm threshold for the impedance between the AC grid and the ground for the PID module. If the detected impedance is below the threshold, the PID module will generate an alarm.</p>

Parameter	Description
Compensation offset voltage	<p>Specifies the compensation offset voltage between PV and the ground after the PID module operates stably.</p> <p>The absolute value ranges from 0 V to 500 V, and the default value is 50 V.</p> <ul style="list-style-type: none"> • If PV module compensation voltage direction is set to PV- po, this parameter indicates the positive voltage between the PV- and the ground. The compensation range is 0 V to +500 V. • If PV module compensation voltage direction is set to PV+ ne, this parameter indicates the negative voltage between the PV+ and the ground. The compensation range is -500 V to 0 V. <p>NOTE</p> <ul style="list-style-type: none"> • If Compensation offset voltage is set to 500 V, the PID module provides the maximum output to enhance the voltage compensation effect. The output voltage amplitude of the PID module is automatically capped to ensure the safety of a PV plant. The output voltage amplitude is also related to the maximum system DC-to-ground withstand voltage and maximum output voltage. • After this parameter is set, wait until the PID module runs properly and use a multimeter to measure the voltage between the PV input terminal of the inverter and the ground. (PV- po: the voltage between the PV- and the ground is greater than or equal to 0 V; PV+ ne: the voltage between the PV+ and the ground is less than or equal to 0 V.)
Clear data	<p>Clears the active alarms and historical alarms stored on the PID module.</p> <p>You can select Clear data to clear active alarms and historical alarms for the PID module.</p>

6.3.16.1.2 PID-PVBOX Running Parameters

Parameter	Description
Operating mode	<p>Specifies the current working mode of the PID module.</p> <ul style="list-style-type: none"> • Before setting this parameter to Manual, ensure that the inverters in the PV array have shut down and the DC switches of the inverters have been turned off. This working mode is used during startup commissioning or fault locating. In this condition, the PID-PVBOX delivers the output voltage based on the value of the commissioned output voltage. • After checking that the PID module is running properly, set this parameter to Automatic.
Output voltage (manual)	<p>Specifies the output voltage when the PID module works in commissioning mode.</p>
Repair time	<p>Specifies the recovery time for each day.</p>

Parameter	Description
Voltage to be repaired	Specifies the output voltage when the PID module works in commissioning mode.

6.3.16.1.3 PID-SSC Running Parameters

Parameter	Description
Operating mode	Specifies the current working mode of the PID module. <ul style="list-style-type: none">• Set this parameter to Manual during commissioning after deployment or fault locating. In this case, the PID-SSC delivers the output voltage based on the value of the commissioned output voltage.• After checking that the PID module is running properly, set this parameter to Automatic.
Output voltage (manual)	Specifies the output voltage when the PID module works in commissioning mode. It is recommended that Output voltage (manual) be set to a value greater than 250 V.

6.3.16.2 Setting SmartPID2000 Parameters

Table 6-15 Setting PID running parameters

Tab	Parameter	Description
Running Param.	Offset mode	Specifies the offset mode of the PID module. <ul style="list-style-type: none">• Disabled: The PID module is not required.• N/PE: The PID module is required to output voltage from the grid.

Tab	Parameter	Description
	PV module compensation voltage direction	<p>Specifies the compensation direction of the PID module.</p> <ul style="list-style-type: none">● PV- po: The voltage between the PV- and the ground is increased to a value greater than 0 V through voltage compensation. Select PV- po for P-type PV modules or the N-type PV modules that comprise the cells whose positive and negative polarities are on different sides. For example, P-type PV modules, HIT, CIS, thin-film PV modules, and CdTe PV modules meet the requirement for PV- positive offset.● PV+ ne: The voltage between the PV+ and the ground is decreased to lower than 0 V through voltage compensation. Select PV+ ne for the N-type PV modules that comprise the solar cells whose positive and negative polarities are on the same side. <p>NOTE When designing a PV plant, the design institute and user should confirm with the PV module vendor about the direction of voltage compensation for the anti-PID effect of PV modules.</p>
	Working mode	<p>Specifies the working mode of the PID module.</p> <ul style="list-style-type: none">● Automatic: In normal mode, the PID module operates automatically after the PID module, inverter, and SmartLogger communicate with each other properly.● Manual: In commissioning mode, no inverter needs to be connected. The PID module can run independently and is used for commissioning only. <p>NOTICE</p> <ul style="list-style-type: none">● Compensation offset voltage is displayed and can be set only when Working mode is set to Automatic.● Output voltage (manual) is displayed and can be set only when Working mode is set to Manual.● Before the first power-on, to check whether the PID module functions properly, it is recommended that Working mode be set to Manual. If the PID module functions properly, set Working mode to Automatic.

Tab	Parameter	Description
	Compensation offset voltage	<p>Specifies the PV-ground compensation offset voltage after the PID module works stably in automatic mode. The absolute value ranges from 0 V to 500 V, and the default value is 50 V.</p> <ul style="list-style-type: none"> • If PV module compensation voltage direction is set to PV- po, this parameter indicates the positive voltage between the PV- and the ground. The compensation range is 0 V to +500 V. • If PV module compensation voltage direction is set to PV+ ne, this parameter indicates the negative voltage between the PV+ and the ground. The compensation range is -500 V to 0 V. • If Compensation offset voltage is set to 500 V, the PID module provides the maximum output to enhance the voltage compensation effect. The output voltage amplitude of the PID module is automatically capped to ensure the safety of a PV plant. The output voltage amplitude is also related to the maximum system DC-to-ground withstand voltage and maximum output voltage. • After this parameter is set, wait until the PID module runs properly and use a multimeter to measure the voltage between the PV input terminal of the inverter and the ground. (PV- po: the voltage between the PV- and the ground is greater than or equal to 0 V; PV+ ne: the voltage between the PV+ and the ground is less than or equal to 0 V.)
	Output voltage (manual)	<p>Specifies the step-up voltage when the working mode is manual. The value of this parameter ranges from 0 V to 800 V.</p> <p>It is recommended that the commissioning output voltage for a 1000 V/1100 V inverter be set to a value ranging from 50 V to 400 V, and that the commissioning output voltage for the 1500 V inverter be set to a value ranging from 50 V to 600 V.</p> <p>NOTE Maximum output voltage can be displayed and set based on the actual networking if there is no battery in the network.</p>

Tab	Parameter	Description
	Maximum output voltage	<p>The value of this parameter ranges from 0 V to 800 V. The default value is 500 V. For a 1500 V inverter, the recommended value is 800 V.</p> <ul style="list-style-type: none"> For a 1000 V/1100 V inverter, the value ranges from 0 V to 550 V. The parameter value indicates the maximum DC step-up voltage between PV and the ground. For a 1500 V inverter, the value ranges from 0 V to 800 V. The parameter value indicates the maximum DC step-up voltage between PV and the ground. <p>NOTICE Maximum output voltage can be displayed and set based on the actual networking if there is no battery in the network.</p>
	Maximum system DC-to-ground withstand voltage	<p>Specifies the voltages between the PV side and the ground and between the AC side and the ground in automatic mode. The value of this parameter ranges from 500 V to 1500 V.</p> <p>Specifies the lower threshold of the maximum voltage range between the inverter DC side (including the inverter, PV module, cable, SPD, and switch) and the ground.</p> <p>The default value is 1000 V. For a 1500 V inverter, the recommended value is 1500 V.</p> <p>NOTICE Maximum system DC-to-ground withstand voltage can be displayed and set based on the actual networking if there is no battery in the network.</p>
	IMD access	<p>Specifies whether the PID module and insulation monitor device (IMD) can operate in cycle mode.</p> <ul style="list-style-type: none"> Select Enable if you allow the PID module and IMD to operate in cycle mode. Select Disable if you forbid the access of IMDs. <p>NOTICE</p> <ul style="list-style-type: none"> This parameter can be displayed and set only when Smart insulation monitoring is set to Disable. Periodic PID runtime and Periodic IMD runtime can be displayed and set only when IMD access is set to Enable.
	Periodic PID runtime	<p>Specifies the running duration of the PID module when the PID module and IMD operate in cycle mode. The value of this parameter ranges from 60 min to 480 min. The IMD is shut down when the PID module is running.</p>
	Periodic IMD runtime	<p>Specifies the running duration of the IMD when the PID module and IMD operate in cycle mode. The value of this parameter ranges from 15 min to 480 min. The PID module is standby when the IMD is running.</p>

Tab	Parameter	Description
	Smart insulation monitoring^[1]	<p>If no IMD is configured in the actual networking, you are advised to purchase and load the PID license. After the license is successfully loaded, set Smart insulation monitoring to Enable to enable the PID-to-ground insulation resistance detection function. If you do not need this function, set this parameter to Disable.</p> <p>NOTICE</p> <ul style="list-style-type: none"> • IMD access is shielded only when this parameter is set to Enable. • System-to-ground insulation resistance is displayed only when this parameter is set to Enable. • System-to-ground resistance alarm threshold, System-to-ground resistance warning threshold, System-to-ground impedance detection time, Trigger ACB tripping upon IMD alarm, and Corresponding transformer winding can be displayed and set only when Smart insulation monitoring is set to Enable. • In the PV-only scenario, if Smart insulation monitoring is set to Enable: <ol style="list-style-type: none"> 1. Choose Monitoring > Inverter > Running Param. > Feature Parameters and check whether PID protection at night is set to Enable. If it is set to Disable, manually set it to Enable. 2. Choose Monitoring > Inverter > Running Param. > Feature Parameters and check whether the setting of PID compensation direction is consistent with that of PV module compensation voltage direction in Monitoring > PID > Running Param. If the settings are inconsistent, change the setting of PID compensation direction.
	System-to-ground resistance alarm threshold^[1]	<p>Specifies the alarm threshold for the system-to-ground resistance of the PID module. When the resistance is less than this threshold, the PID module will generate an alarm. The recommended value ranges from 5.0 kΩ to 50.0 kΩ. The default value is 8.0 kΩ.</p> <p>System-to-ground resistance alarm threshold < System-to-ground resistance warning threshold.</p>
	System-to-ground resistance warning threshold^[1]	<p>Specifies the warning threshold for the system-to-ground resistance of the PID module. When the resistance is less than this threshold, the PID module will generate a warning. The recommended value ranges from 5.0 kΩ to 50.0 kΩ. The default value is 10.0 kΩ.</p> <p>System-to-ground resistance alarm threshold < System-to-ground resistance warning threshold.</p>
	System-to-ground impedance detection time^[1]	<p>Specifies the system-to-ground impedance detection time. When the impedance is lower than the detection point for a period longer than the detection time, an alarm or warning is generated. The value of this parameter ranges from 10s to 1800s. The default value is 100s.</p>

Tab	Parameter	Description
	Trigger ACB tripping upon IMD alarm^[1]	Specifies whether to trigger ACB tripping for the transformer station when a system-to-ground resistance alarm is generated. Set this parameter to Disable or Enable based on the actual application scenario. If this parameter is set to Enable , the entire system shuts down when a system-to-ground resistance alarm is generated.
	Corresponding transformer winding^[1]	Configure the winding number of the transformer station corresponding to the current PID module. Select Low-voltage cabinet A or Low-voltage cabinet B based on the actual application scenario.
Running Info.	System-to-ground insulation resistance^[2]	When the system-to-ground insulation resistance is lower than the system-to-ground resistance alarm threshold and warning threshold, the system generates an alarm.
<p>Note [1]: This parameter can be displayed and set in SmartPID2000 V100R001SPC112, SmartLogger V300R023C00SPC153, and later versions.</p> <p>Note [2]: This parameter can be displayed in SmartPID2000 V100R001SPC112, SmartLogger V300R023C00SPC153, and later versions.</p>		

6.3.17 Setting Meter Parameters

6.3.17.1 Setting DL/T645 Meter Parameters

Procedure

Step 1 Set access parameters and click **Add Devices**.

Figure 6-53 Setting access parameters

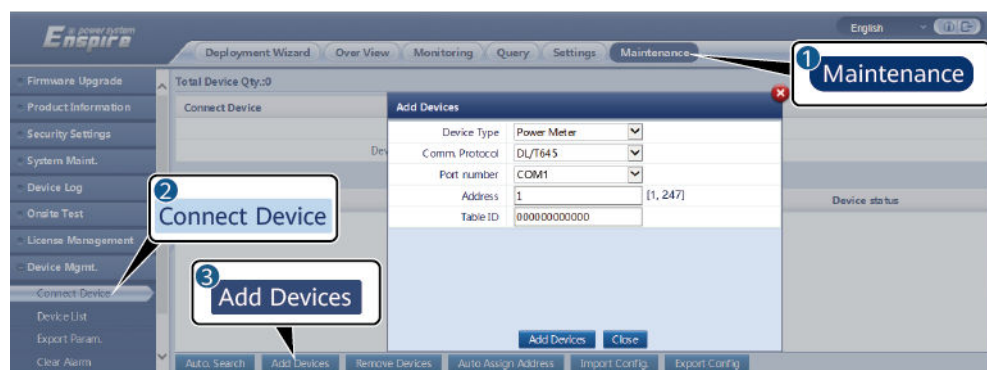

IL03J00019

Parameter	Description
Device Type	Set this parameter to Power Meter .

Parameter	Description
Comm. Protocol	Set this parameter to DL/T645 .
Port number	Set this parameter to the COM port connected to the meter.
Address	Set this parameter to the communication address of the meter.
Table ID	Set this parameter to the meter ID.

Step 2 Choose **Monitoring > Meter > Running Param.**, set running parameters, and click **Submit**.

Parameter	Description
Protocol version	Select DL/T645-2007 or DL/T645-1997 based on the protocol version of the meter.
Number of lead bytes	Retain the default value unless otherwise specified.
Voltage change ratio	<ul style="list-style-type: none"> Set this parameter to 1 if the meter uploads the primary value. Set this parameter based on the actual transformer ratio if the meter uploads the secondary value.
Current change ratio	
Meter usage	<p>Meters include export+import meters, production meters, consumption meters, charger meters, and external production meters.</p> <ul style="list-style-type: none"> Export+import meter: used for grid-connection point control. Each array allows only one export +import meter to be connected. Production meter: PV output meter. Multiple production meters can be connected. Consumption meter: load consumption meter. Multiple consumption meters can be connected. Charger meter: charger consumption meter. Multiple charger meters can be connected. This parameter can be configured only in V300R023C00SPC160 and later versions. External production meter: third-party PV output meter. Multiple external production meters can be connected.

Parameter	Description
Meter access direction ^[1]	<p>This switch is used when the physical wiring of the meter is reversely connected. You can adjust the software switch to avoid wiring reconstruction of the meter. Only the following three scenarios are supported. If Meter access direction is incorrectly set, data will be incorrectly reported.</p> <ul style="list-style-type: none"> • Positive: The default value is Positive, which applies to the scenario where cables are correctly connected to the meter. • Reverse: If the meter is reversely connected and the NMS does not support reverse connection, set this parameter to Reverse. The SmartLogger automatically adjusts the power and other data of the meter to ensure data accuracy for the plant and meter. • Reverse_Report raw data: If the meter is reversely connected and the NMS supports reverse connection^[2], set this parameter to Reverse_Report raw data. This parameter is valid only for Export+import meter. The SmartLogger reports the original data of the meter to the NMS, and the NMS adjusts the data such as power.
<p>Note [1]: Meter access direction can be configured only in V300R001C00SPC609 and later, V800R021C10SPC140 and later, and V300R023C00 and later.</p> <p>Note [2]: If cables are reversely connected to the meter and the NMS can correctly display the real-time data of the meter, it is considered that the NMS supports reverse connection. That is, the NMS reverses the active power, reactive power, power factor, phase A active power, phase B active power, and phase C active power, replaces the total positive active energy and total negative active energy with each other, and replaces the total positive reactive power and total negative reactive power with each other.</p>	

 NOTE

- When **Meter access direction** is set to **Positive** or **Reverse**, **Electric meter power direction** must be set to **Positive**. **Electric meter power direction** is set in the grid connection with limited power under active power control and power closed-loop control under reactive power control.
- When **Meter access direction** is set to **Reverse_Report raw data**, **Electric meter power direction** must be set to **Reverse**. **Electric meter power direction** is set in the grid connection with limited power under active power control and power closed-loop control under reactive power control.

----End

6.3.17.2 Setting Modbus-RTU Meter Parameters

Procedure

Step 1 Set access parameters and click **Add Devices**.

Figure 6-54 Setting access parameters

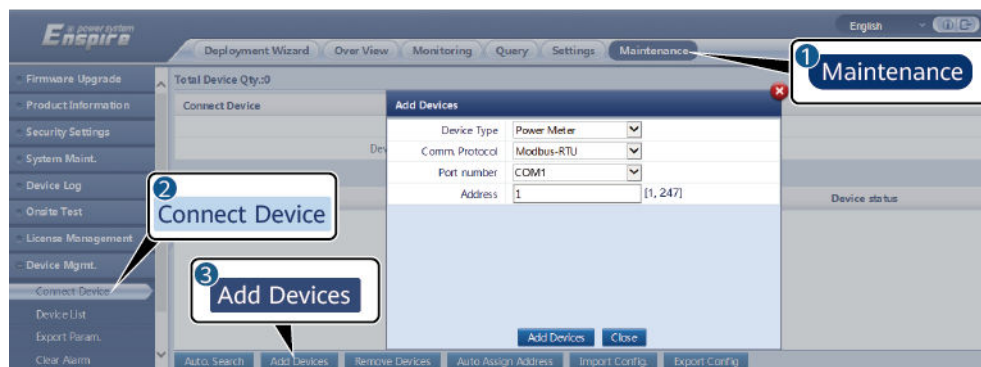

IL03J00022

Parameter	Description
Device Type	Set this parameter to Power Meter .
Comm. Protocol	Set this parameter to Modbus-RTU .
Port number	Set this parameter to the COM port connected to the meter.
Address	Set this parameter to the communication address of the meter.

Step 2 Choose **Monitoring > Meter > Running Param.**, set meter parameters, and click **Submit**.

- When the model of the connected meter is in the **Intelligent Power Meter Type** drop-down list, set the parameters as follows.

Parameter	Description
Intelligent Power Meter Type	Set this parameter to the corresponding meter model.
Voltage change ratio	<ul style="list-style-type: none"> Set this parameter to 1 if the meter uploads the primary value. Set this parameter based on the actual transformer ratio if the meter uploads the secondary value.
Current change ratio	

Parameter	Description
Meter usage	<p>Meters include export+import meters, production meters, consumption meters, charger meters, and external production meters.</p> <ul style="list-style-type: none"> ● Export+import meter: used for grid-connection point control. Each array allows only one export +import meter to be connected. ● Production meter: PV output meter. Multiple production meters can be connected. ● Consumption meter: load consumption meter. Multiple consumption meters can be connected. ● Charger meter: charger consumption meter. Multiple charger meters can be connected. This parameter can be configured only in V300R023C00SPC160 and later versions. ● External production meter: third-party PV output meter. Multiple external production meters can be connected.
Meter access direction ^[1]	<p>This switch is used when the physical wiring of the meter is reversely connected. You can adjust the software switch to avoid wiring reconstruction of the meter. Only the following three scenarios are supported. If Meter access direction is incorrectly set, data will be incorrectly reported.</p> <ul style="list-style-type: none"> ● Positive: The default value is Positive, which applies to the scenario where cables are correctly connected to the meter. ● Reverse: If the meter is reversely connected and the NMS does not support reverse connection, set this parameter to Reverse. The SmartLogger automatically adjusts the power and other data of the meter to ensure data accuracy for the plant and meter. ● Reverse_Report raw data: If the meter is reversely connected and the NMS supports reverse connection^[2], set this parameter to Reverse_Report raw data. This parameter is valid only for Export+import meter. The SmartLogger reports the original data of the meter to the NMS, and the NMS adjusts the data such as power.

Parameter	Description
	<p>Note [1]: Meter access direction can be configured only in V300R001C00SPC609 and later, V800R021C10SPC140 and later, and V300R023C00 and later.</p> <p>Note [2]: If cables are reversely connected to the meter and the NMS can correctly display the real-time data of the meter, it is considered that the NMS supports reverse connection. That is, the NMS reverses the active power, reactive power, power factor, phase A active power, phase B active power, and phase C active power, replaces the total positive active energy and total negative active energy with each other, and replaces the total positive reactive power and total negative reactive power with each other.</p>

 NOTE

- When **Meter access direction** is set to **Positive** or **Reverse**, **Electric meter power direction** must be set to **Positive**. **Electric meter power direction** is set in the grid connection with limited power under active power control and power closed-loop control under reactive power control.
- When **Meter access direction** is set to **Reverse_Report raw data**, **Electric meter power direction** must be set to **Reverse**. **Electric meter power direction** is set in the grid connection with limited power under active power control and power closed-loop control under reactive power control.
- If the connected meter is of another model, set the parameters as follows.

Parameter	Description
Intelligent Power Meter Type	Set this parameter to Other .
Read function code	Read holding register 03H and Read input register 04H are supported. Set this parameter based on the vendor's protocol.
Read mode	Multiple read and Single read are supported.
Word order	Big endian and Little endian are supported. Set this parameter based on the vendor's protocol.
Start address	When Read mode is set to Multiple read , set the start address.
End address	When Read mode is set to Multiple read , set the end address.
Voltage change ratio	<ul style="list-style-type: none"> • Set this parameter to 1 if the meter uploads the primary value. • Set this parameter based on the actual transformer ratio if the meter uploads the secondary value.
Current change ratio	

Parameter	Description
Signal parameters NOTE Signal parameters include Signal Name, Signal address, Number of Registers, Gain, Data Type, and Unit.	Set this parameter based on the vendor's protocol. NOTE If the power meter can collect a certain signal, set Signal address to the address of the corresponding register. If not, set Signal address to 65535 .

----End

6.3.18 Setting EMI Parameters

6.3.18.1 Setting Modbus-RTU EMI Parameters

Procedure

Step 1 Set access parameters and click **Add Devices**.

Figure 6-55 Setting access parameters

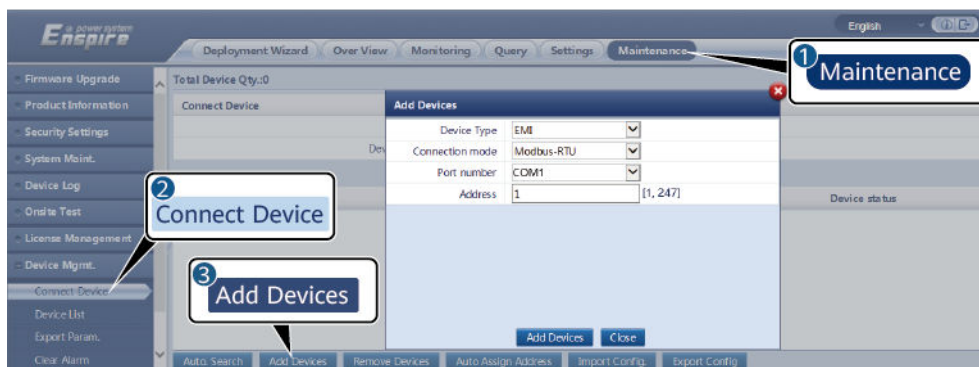

IL03J00023

Parameter	Description
Device Type	Set this parameter to EMI .
Connection mode	Set this parameter to Modbus-RTU .
Port number	Set this parameter to the serial number of the COM port connected to the EMI.
Address	Set this parameter to the communication address of the EMI.

Step 2 Choose **Monitoring > EMI > Running Param.**, set running parameters and click **Submit**.

- If the model of the connected EMI is displayed in the **EMI model** drop-down list box, set parameters as follows.

Parameter	Description
EMI model	Set this parameter to the model of the connected EMI.
Synchronize Environment Data	You are advised to retain the default value Disable . NOTE When this parameter is set to Enable , the SmartLogger transmits the wind speed and direction data to the solar inverter in a PV plant with the tracking system.
Threshold of fast synchronization of wind speeds	<ul style="list-style-type: none"> • This parameter can be manually set. The value ranges from 15.0 to 30.0. • When the actual wind speeds collected by all running EMIs are within the threshold of fast synchronization of wind speeds, all EMIs synchronize the real-time wind speeds to inverters every minute by default. The inverters forward the real-time wind speeds to trackers. • When the actual wind speed collected by any running EMI exceeds the threshold, all running EMIs will send the real-time wind speeds five times at an interval of 10s. After that, the real-time wind speeds are synchronized to the inverters every minute.
Master/Slave	When the SmartLogger connects to multiple EMIs, set one of them to master mode . The solar inverter performance data displayed is the data of the EMI in master mode .

- If the connected EMI is a split EMI that supports Modbus-RTU, set parameters as follows.

Parameter	Description
EMI model	Set this parameter to Sensor(ADAM) .
Synchronize Environment Data	You are advised to retain the default value Disable . NOTE When this parameter is set to Enable , the SmartLogger transmits the wind speed and direction data to the solar inverter in a PV plant with the tracking system.

Parameter	Description
Master/Slave	<p>When the SmartLogger connects to multiple EMIs, set one of them to master mode. Both the inverter performance data and plant performance data pages display data on the EMI in master mode.</p> <p>NOTE</p> <ul style="list-style-type: none"> • If a single EMI is set to master mode or slave mode, the EMI data is displayed in both the inverter performance data and plant performance data pages. • When the SmartLogger connects to multiple EMIs, only one EMI can be set to master mode. If multiple EMIs are set to master mode, only the last configuration takes effect, that is, the last EMI is set to master mode and the other EMIs are automatically switched to slave mode. • If multiple EMIs are connected to the SmartLogger and these EMIs are set to slave mode, the performance data of the first connected EMI is displayed in both the inverter performance data and plant performance data pages.
Read function code	Set this parameter to Read holding register 03H or Read holding register 04H based on the protocol adopted by the vendor.
Data reporting mode	Set this parameter to Integer or Floating point based on the protocol adopted by the vendor.
Word ordering	Set this parameter to Big endian or Little endian based on the protocol adopted by the vendor.
Read mode	The value can be Multiple read or Single read .
Start address	If Read mode is set to Multiple read , set the start address for reading.
End address	If Read mode is set to Multiple read , set the end address for reading.
Signal parameters	Set these parameters based on the vendor protocol.
<p>NOTE</p> <p>Signal parameters include Signal Name, Signal address, Lower Thres., Upper Thres., Spec, Start (mV/mA), End (mV/mA), and Unit.</p>	<p>NOTE</p> <p>If the EMI can collect a signal, set Signal address for the signal to the corresponding register address. If the EMI cannot collect a signal, set Signal address for the signal to 65535.</p>

- If the connected EMI is of another model, set parameters as follows.

Parameter	Description
EMI model	Set this parameter to Other .

Parameter	Description
Synchronize Environment Data	You are advised to retain the default value Disable . NOTE When this parameter is set to Enable , the SmartLogger transmits the wind speed and direction data to the solar inverter in a PV plant with the tracking system.
Master/Slave	When the SmartLogger connects to multiple EMIs, set one of them to master mode . The solar inverter performance data displayed is the data of the EMI in master mode .
Read function code	Set this parameter to Read holding register 03H or Read holding register 04H based on the protocol adopted by the vendor.
Data reporting mode	Set this parameter to Integer or Floating point based on the protocol adopted by the vendor.
Word ordering	Set this parameter to Big endian or Little endian based on the protocol adopted by the vendor.
Read mode	The value can be Multiple read or Single read .
Start address	If Read mode is set to Multiple read , set the start address for reading.
End address	If Read mode is set to Multiple read , set the end address for reading.
Signal parameters NOTE Signal parameters include Signal Name , Signal address , Gain , Offset , and Unit .	Set these parameters based on the vendor protocol. NOTE If the EMI can collect a signal, set Signal address for the signal to the corresponding register address. If the EMI cannot collect a signal, set Signal address for the signal to 65535 .

----End

6.3.18.2 Setting AI EMI Parameters

Procedure

Step 1 Set access parameters and click **Add Devices**.

Figure 6-56 Setting access parameters

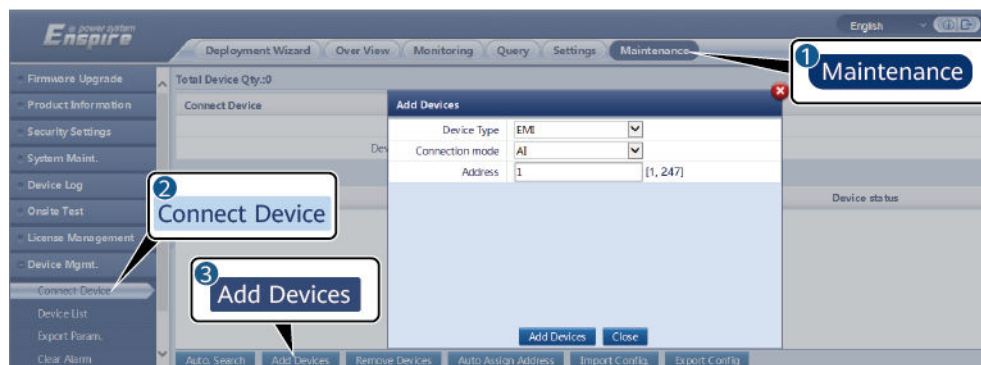

IL03J00025

Parameter	Description
Device Type	Set this parameter to EMI .
Connection mode	Set this parameter to AI .
Address	Set this parameter to the communication address of the EMI.

Step 2 Choose **Monitoring > EMI > Running Param.**, set running parameters and click **Submit**.

Parameter	Description
Synchronize Environment Data	You are advised to retain the default value Disable . NOTE When this parameter is set to Enable , the SmartLogger transmits the wind speed and direction data to the solar inverter in a PV plant with the tracking system.
Master/Slave	When the SmartLogger connects to multiple EMIs, set one of them to master mode . The solar inverter performance data displayed is the data of the EMI in master mode .
Signal parameters NOTE Signal parameters include Signal Name , Port number , Lower Thres. , Upper Thres. , Start (V/mA) , End (V/mA) , and Unit .	Set these parameters as required. NOTE When you need to change the configured port number, set Port number to No first, then to the required port number.

Step 3 If **Port number** is set to the number of the connected PT port, click **PT T Correction** to correct the temperature.

----End

6.3.19 Setting STS Parameters

The STS can be connected to the SmartLogger over RS485 or FE. If the STS is connected to the SmartLogger over RS485, you need to manually add devices and set access parameters. If the STS is connected over FE, the SmartLogger automatically identifies the STS.

Procedure

Step 1 (Optional) If the STS connects to the SmartLogger over RS485, click **Add Device** and set access parameters.

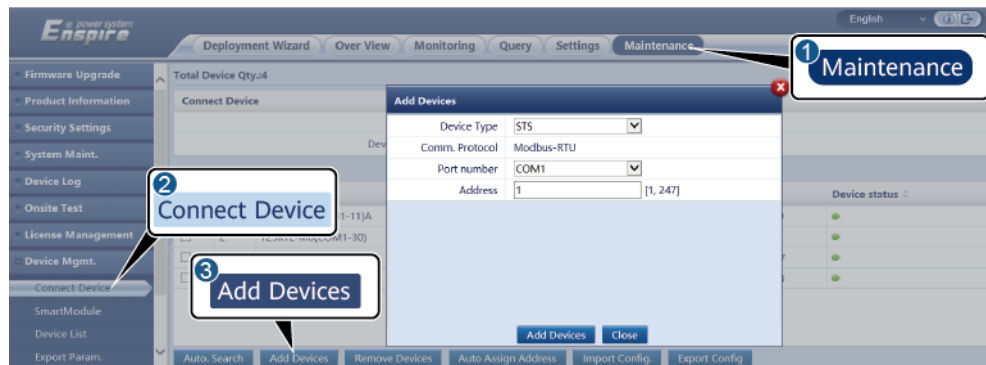

IL04J00006

Parameter	Description
Device Type	Set this parameter to STS .
Port number	Set this parameter to the number of the COM port connected to the STS.
Address	Set this parameter to the communications address of the STS.

Step 2 Choose **Monitoring > STS**, set device monitoring parameters and click **Submit**.

Tab	Function	Description
Teleindication	Views the status parameters of the device, such as the switched-on or switched-off state.	N/A
Telemetry	Views the real-time data of the device, such as the voltage.	N/A
Telecontrol	Sets status control parameters, such as the parameter for controlling switch-on or switch-off.	Set this parameter as required.

Tab	Function	Description
Performance Data	Views or exports the performance data of the device.	N/A
Running Param.	Sets the standby signals for teleindication, telemetry, and teleadjust.	Set this parameter as required.
Active Alarm	Queries active alarms.	N/A
About	Queries communication information.	N/A

Step 3 Choose **Settings > Other Parameters** and set **STS overtemperature protection** as required.

----End

6.3.20 Setting IEC103 Device Parameters

Description

An IEC103 device supports two data transmission modes:

- **Transparent transmission mode:** When connecting to the management system, the SmartLogger transparently transmits the IEC103 device information to the management system. The SmartLogger does not parse the IEC103 device data.
- **Parsing mode:** The IEC103 device is connected to the SmartLogger, and the SmartLogger parses the IEC103 device data.

Transparent Transmission Mode

Step 1 Set IEC103 parameters and click **Submit**.

Figure 6-57 Setting IEC103 parameters

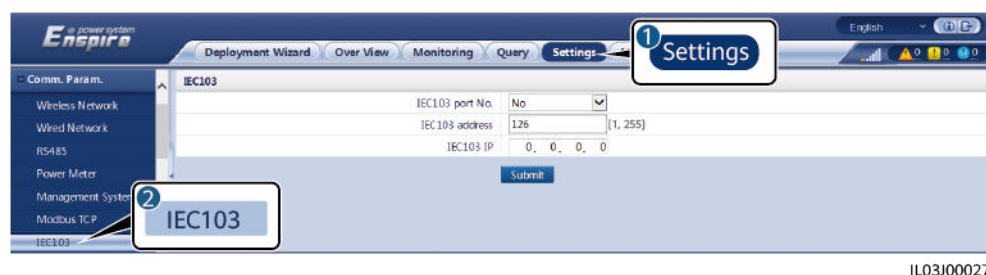

IL03J00027

Parameter	Description
IEC103 port No.	Set this parameter based on the COM port connected to the device.

Parameter	Description
IEC103 address	Set this parameter to the IEC103 device address.
IEC103 IP	Set this parameter to the IP address of the management system.

Step 2 Choose **Settings > Other Parameters** and check that **Data forwarding** is set to **Enable**.

NOTICE

- If **Data forwarding** is set to **Enable**, the SmartLogger transparently transmits information about unconnected devices to the management system without parsing device data.
- If **Data forwarding** is set to **Disable**, the SmartLogger does not transmit information about unconnected devices to the management system.

----End

Parsing Mode

The SmartLogger can connect to third-party devices that support IEC103, such as the relay protection or monitoring device like the transformer substation. The protocol information points vary depending on vendors. Therefore, you need to obtain a protocol information file in **.cfg** format from Huawei and import the file into the SmartLogger for successfully connecting to a custom device.

The supported device types are IEC103 device 1 to IEC103 device 5. The corresponding configuration file names are **iec103_equip_custom_1.cfg** to **iec103_equip_custom_5.cfg**. Multiple devices of the same type can be connected.

Step 1 Configure a protocol information point file in **.cfg** format and import the file to the SmartLogger.

Figure 6-58 Importing configuration

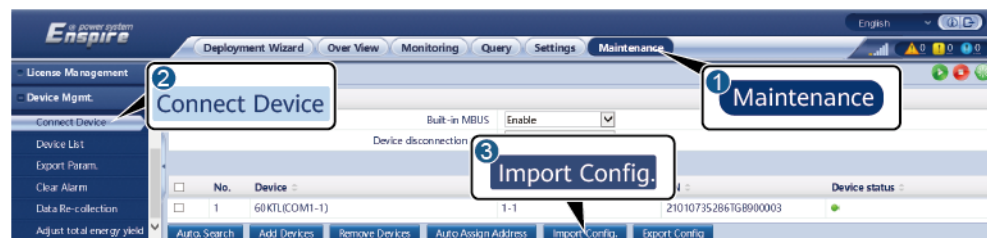

IL03J00028

Step 2 Set access parameters and click **Add Devices**.

Figure 6-59 Setting access parameters

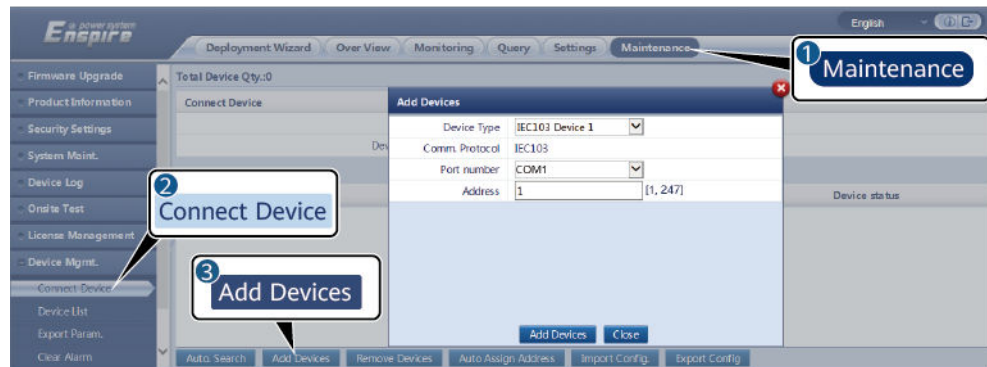

IL03J00029

Parameter	Description
Device Type	The value can be IEC103 Device 1 to IEC103 Device 5 . Select a value based on the configuration file. For example, if iec103_equip_custom_1.cfg needs to be imported, select IEC103 Device 1 .
Port number	Set this parameter to the COM port connected to the IEC103 device.
Address	Set this parameter to the communication address of the IEC103 device.

Step 3 Set device monitoring parameters and click **Submit**.

Figure 6-60 Device monitoring



IL03J00030

Tab	Function	Description
Running Info.	View the running information about the IEC103 device.	N/A
Teleindication	View the device status, such as the switch status.	N/A

Tab	Function	Description
Telemetry	View the real-time analog data of the device, such as the voltage.	N/A
Telecontrol	Set the status control parameters, such as the parameters for turning on or off switches.	Set the parameters on the tab page as required.
Teleadjust	Set analog parameters, for example, set voltage protection parameters.	Set the parameters on the tab page as required.

----End

6.3.21 Setting IEC 104 Device Parameters

Context

The SmartLogger can connect to third-party devices that support the IEC 104 protocol, such as relay protection or measurement and control devices such as transformer stations. The protocol information points vary depending on vendors. Therefore, you need to configure a protocol information file in .cfg format. To connect devices to the SmartLogger, the supplier or Huawei engineers need to modify the parameters in the device configuration table file delivered with the version based on device requirements, generate a protocol information file in .cfg format, and import the file to the SmartLogger.

The supported device types are **IEC104 Device 1** to **IEC104 Device 5**. The corresponding configuration file names are **iec104_equip_custom_1.cfg** to **iec104_equip_custom_5.cfg**. Multiple devices of the same type can be connected.

Procedure

- Step 1** Configure the protocol information point file in .cfg format and import the file to the SmartLogger.

Figure 6-61 Importing configuration

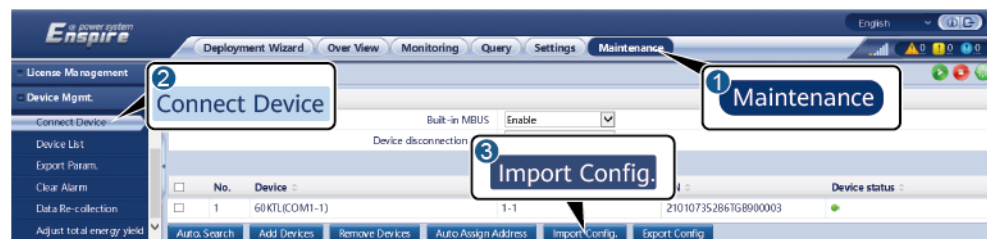

IL03J00028

- Step 2** Click **Add Devices** and set access parameters.

Figure 6-62 Setting access parameters

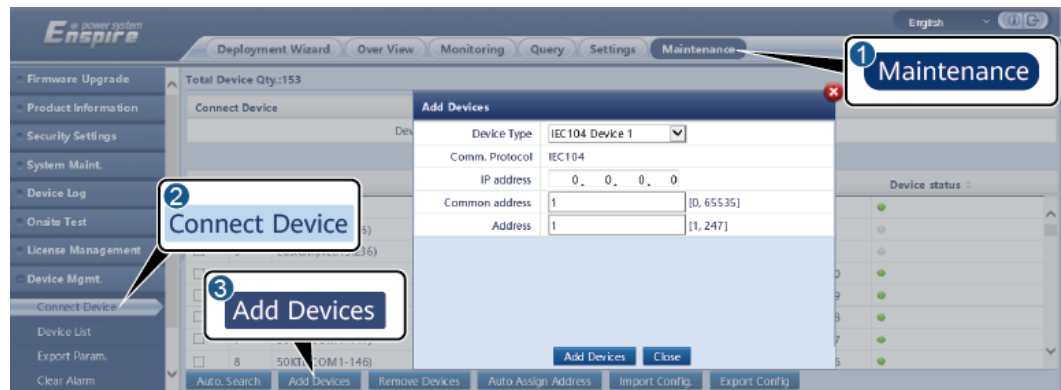

IL04J00012

Parameter	Description
Device Type	Currently, IEC104 Device 1 to IEC104 Device 5 are supported. Set this parameter based on the configuration import file. For example, if you import iec104_equip_custom_1.cfg , select IEC104 Device 1 .
IP address	Set this parameter to the IP address of the IEC 104 device.
Common address	Set this parameter to the common address of the IEC 104 device.
Address	Set this parameter to the communications address of the IEC 104 device.

Step 3 Set monitoring parameters and click **Submit**.

Figure 6-63 Monitoring



IL04J00013

Tab	Function	Setting
Running Info.	Displays the running information about the IEC 104 device.	-

Tab	Function	Setting
Teleindication	Displays the device status, such as the switch status.	-
Telemetrying	Displays the real-time analog data of the device, such as the voltage.	-
Telecontrol	Allows users to set status control parameters, such as the parameter for controlling switch-on or switch-off.	Set this parameter as required.
Teleadjust	Allows users to set analog parameters, such as voltage protection parameters.	Set this parameter as required.

----End

6.3.22 Setting Custom Device Parameters

Context

The SmartLogger can connect to third-party devices supporting the Modbus RTU protocol, such as transformer stations and EMIs. The protocol information points vary depending on vendors. Therefore, you need to configure a protocol information file in .cfg format. To connect devices to the SmartLogger, the supplier or Huawei engineers need to modify the parameters in the device configuration table file delivered with the version based on device requirements, generate a protocol information file in .cfg format, and import the file to the SmartLogger.

The supported device types are **Custom Device1** to **Custom Device10**. The corresponding configuration file names are **modbus_equip_custom_1.cfg** to **modbus_equip_custom_10.cfg**. Multiple devices of the same type can be connected.

Procedure

- Step 1** Configure the protocol information point file in .cfg format and import the file to the SmartLogger.

Figure 6-64 Importing configuration



IL03J00028

Step 2 Click **Add Devices** and set access parameters.

Figure 6-65 Setting access parameters

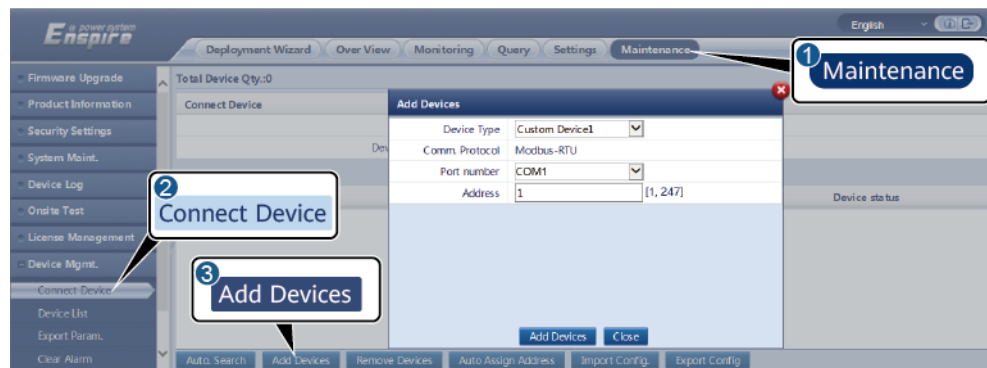

IL03J00031

Parameter	Setting
Device Type	Currently, Custom Device1 to Custom Device10 are supported. Set this parameter based on the configuration import file. For example, if you import modbus equip_custom_1.cfg , select Custom Device1 .
Port number	Set this parameter to the number of the COM port connected to the custom device.
Address	Set this parameter to the communications address of the custom device.

Step 3 Set monitoring parameters and click **Submit**.

Figure 6-66 Monitoring

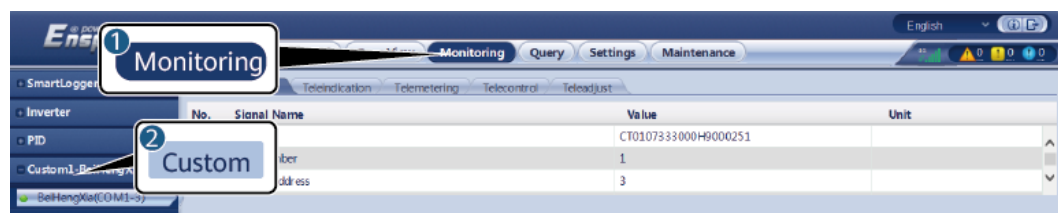

IL03J00032

Tab	Function	Setting
Running Info.	Displays the running information about the custom device.	-

Tab	Function	Setting
Teleindication	Displays the device status, such as the switch status.	-
Telemetry	Displays the real-time analog data of the device, such as the voltage.	-
Telecontrol	Allows users to set status control parameters, such as the parameter for controlling switch-on or switch-off.	Set this parameter as required.
Teleadjust	Allows users to set analog parameters, such as voltage protection parameters.	Set this parameter as required.

----End

6.3.23 Setting Parameters for Poverty Alleviation Monitoring Center

Context

The SmartLogger can be connected to the poverty alleviation monitoring center in either of the following modes:

- Method 1: The SmartLogger connects to the poverty alleviation monitoring center through the FusionSolar SmartPVMS. Method 1 (recommended): Use the FusionSolar SmartPVMS to import the PV plant information configuration package provided by the poverty alleviation monitoring center to the SmartLogger.
- Method 2: The SmartLogger directly connects to the poverty alleviation monitoring center. Method 2: Based on the PV plant information configuration package provided by the poverty alleviation monitoring center, choose **Settings > Poverty Alleviation Monitoring Center** and set the parameters of the SmartLogger poverty alleviation monitoring center. Internet Explorer 8 is used as an example.

Procedure

- Step 1** Set parameters for the poverty alleviation monitoring center and click Submit.

Figure 6-67 Poverty alleviation monitoring center

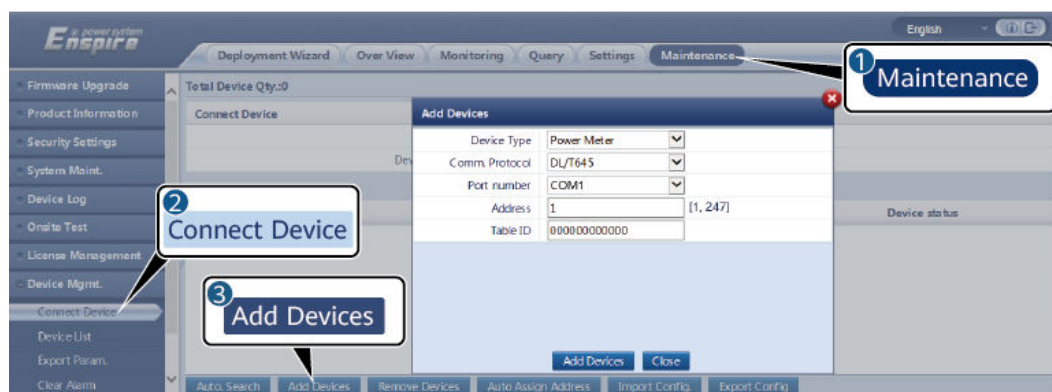

IL03J00019

Parameter		Setting Description
Basic Information	Server	Set this parameter to the address of the poverty alleviation monitoring center server.
	Port	Set this parameter to the port number of the poverty alleviation monitoring center server.
	User Name	Configure the power station information package based on the power station information provided by the poverty alleviation monitoring center.
	Password	
	Device SN:	
	PV plant ID	
	This object indicates the name of a CA certificate file.	
Forwarding table	Solar inverter	

----End

6.3.24 Smart Tracking Algorithm

Context

- Before using the smart tracking algorithm, check whether the plant meets the requirements for using this function based on the onsite smart tracking algorithm delivery checklist, and check whether the Modbus protocol versions between the plant networking devices are compatible.
- The smart tracking algorithm can be configured only after a license is purchased and loaded.

- For details about how to load a license, see [7.4.6 License Management](#).

Procedure

After the trackers are commissioned during onsite delivery, their parameters can be intelligently controlled by the smart tracking algorithm.

1. Choose **Settings > Smart Tracking Algorithm**, set **Tracker working mode** to **Automatic** and **Smart tracking algorithm** to **Enable**. Then, the smart tracking algorithm automatically adjusts tracker parameters such as the angle based on sunlight to maximize energy yield.

Figure 6-68 Smart tracking algorithm parameters

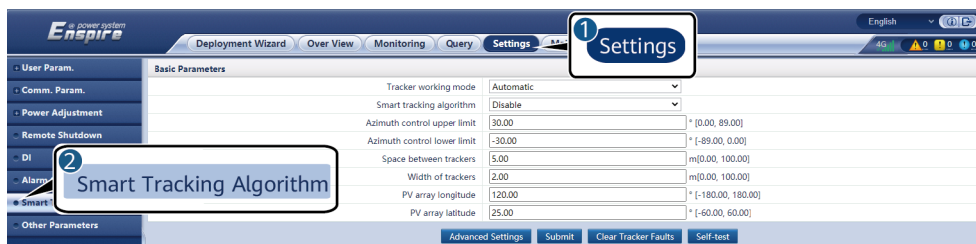

6.3.25 Setting IMD Parameters

Context

The SmartLogger connects to the IMD through RS485. The IMD can be connected only using a whitelist and must be used with the coupler DOLD RP5898/61. This function applies only to the C&I scenario and is supported in SmartLogger V300R023C00SPC172 and later versions.

NOTICE

Ensure that cables are correctly and securely connected to the IMD according to the IMD user manual. If cables are incorrectly connected or in poor contact, the IMD cannot work properly and the insulation resistance detection function fails.

Procedure

1. Choose **Maintenance > Device Mgmt. > Connect Device > Add Devices** to set access parameters.

Parameter	Description
Device Type	Set this parameter to IMD .
Port number	The IMD uses RS485 for communication. Set the COM port connected to the IMD based on site requirements.

Parameter	Description
Address	Set IMD communication address based on site requirements.
Model of equipment	DOLD RN5897.12/011

2. View IMD running information.

Figure 6-69 IMD running information

The screenshot shows the 'Monitoring Info' table in the SmartLogger3000 web interface. The table has four columns: No., Signal Name, Value, and Unit. The data rows are as follows:

No.	Signal Name	Value	Unit
1	SN	IMD0010211004994	
2	Port number	COM3	
3	Comm Address	1	
4	Logical address	21	
5	Device status	Disconnection	

6.4 Setting Battery Control Parameters

This section does not apply to V300R001C00SPC602 and earlier versions.

Battery Control

1. Choose **Settings > Battery Control** to set the battery control working mode.

Table 6-16 Battery control working modes

Working Mode	Mode Description
No control	The SmartLogger directly delivers the external scheduling power limit. No other power scheduling control is performed. The power is automatically controlled by the device.

Working Mode	Mode Description
<p>Maximum self-consumption</p>	<ul style="list-style-type: none"> • This mode applies to areas where the electricity price is high, or areas where the FIT subsidy is low or unavailable. The PV+ESS system generates sufficient PV power for loads and uses the surplus PV power to charge the ESS (if the PV power is insufficient for loads, the TOU mode is recommended). • PV power is preferentially supplied to loads, and the surplus power is used to charge the ESS. If the ESS is fully charged or is being charged at full power, the surplus power is fed to the grid. When PV power is insufficient or no PV power can be generated at night, the ESS discharges power to loads. This improves the self-consumption rate and energy self-sufficiency rate, and reduces electricity costs. The grid cannot charge the ESS but can supply power to loads. • The SmartLogger performs ESS scheduling based on the external scheduling power limit and the preceding policies.
<p>Fully fed to grid</p>	<ul style="list-style-type: none"> • This parameter applies only to distributed scenarios. • This mode maximizes the PV energy fed to the grid. When the PV output power in the daytime is greater than the maximum output capacity of the inverter, the surplus PV power is used to charge the ESS. When the PV output power is less than the maximum output capacity of the inverter, the ESS discharges energy to the inverter to maximize the energy fed from the inverter to the grid. The grid cannot charge the ESS. • The SmartLogger directly delivers the external scheduling power limit. <p>NOTE If the CMU is connected, the Fully fed to grid working mode is not displayed.</p>

Working Mode	Mode Description
<p>TOU</p>	<ul style="list-style-type: none"> ● It is applicable to the PV+ESS system and ESS-only system where peak to valley electricity prices are different and power meters are available. ● You can manually set the charge and discharge time segments. For example, if you set the low electricity price period at night as the charge time, the system charges the batteries at the maximum power during the charge time. If you set the high electricity price period as the discharge time, batteries can discharge only during the discharge time based on the actual load power, reducing electricity costs. ● Click Add to set the charge and discharge time segments. A maximum of 14 time segments can be set. During the charge time, the grid can charge the batteries. During the discharge time, the batteries can supply power to the loads. In other time segments, the batteries do not discharge. The PV system and grid supply power to loads, and the PV system can charge the batteries. ● In some countries, the grid is not allowed to charge batteries. In such case, this mode cannot be used. ● The SmartLogger performs battery scheduling based on the external scheduling power limit and the preceding policies.

Working Mode	Mode Description
<p>TOU (fixed power)^[1]</p>	<ul style="list-style-type: none"> ● It is applicable to the PV+ESS system and ESS-only system where peak to valley electricity prices are different and power meters are unavailable. ● You can manually set the charge and discharge time segments. For example, if you set the low electricity price period at night as the charge time, the system charges the batteries at the fixed power during the charge time. If you set the high electricity price period as the discharge time, batteries can discharge only during the discharge time at the fixed power, reducing electricity costs. ● Click Add to set the charge and discharge time segments. A maximum of 14 time segments can be set. During the charge time, the grid can charge the batteries. During the discharge time, the batteries can supply power to the loads. In other time segments, the batteries do not discharge and are not charged. ● In some countries, the grid is not allowed to charge batteries. In such case, this mode cannot be used. ● The SmartLogger performs battery scheduling based on the external scheduling power limit and the preceding policies.

Working Mode	Mode Description
<p>Charge/Discharge based on grid dispatch</p>	<ul style="list-style-type: none"> • This mode applies to utility-scale plant scheduling scenarios where a third-party controller delivers active power scheduling commands. • The purpose of scheduled discharge is to meet the active power scheduling target value at the grid access point. PV energy is preferred. If the generated PV energy is insufficient, the batteries discharge and the energy is fed to the grid based on the active power scheduling target value. If the generated PV energy is sufficient, the energy is fed to the grid based on the active power scheduling target value, and the surplus PV energy is used to charge the batteries. • The purpose of scheduled charge is to meet the active power scheduling target value at the grid access point. If the battery charge power is insufficient or the Smart PCS limits the power, the grid charges the batteries with the maximum capability. If the batteries are not fully charged when the scheduling target value is met, the PV power is used to charge the batteries.
<p>Custom^[2]</p>	<ul style="list-style-type: none"> • This mode applies to utility-scale plant (with ESSs) scheduling scenarios. Customers can control the battery discharge power. • Non-discharge period: The batteries cannot discharge and can be charged based on the scheduling command. • Discharge period: If Adaptive discharge power is enabled, the control logic is the same as that for scheduled charge and discharge. The battery charge and discharge power is determined by the upper-layer scheduling command. If Adaptive discharge power is disabled, the battery discharge power is fixed to the reference value set by the customer. In this case, the upper-layer scheduling command controls only the PV inverters but not the batteries.
<p>Note [1]: You can set this parameter in SmartLogger V300R023C00SPC150 and later versions.</p> <p>Note [2]: You can set this parameter in SmartLogger V300R023C00SPC120 and later versions.</p>	

Table 6-17 Running parameters in each battery control working mode

Working Mode	Parameter	Description
Maximum self-consumption	Active power threshold of grid during battery discharge	Set the grid power threshold at the grid connection point for loads when the load power is greater than the PV power.
	Adjustment deadband	Set the precision of the grid power at the grid connection point. This parameter affects the power value range at the grid connection point. If the actual grid power threshold at the grid connection point is within this range, i.e. [Maximum grid power during battery discharge – Adjustment deadband, Maximum grid power during battery discharge + Adjustment deadband], the grid power requirement at the grid connection point is met.
	Adaptive adjustment parameters^[1]	Set the adjustment period and step parameters for raising the inverter power. <ul style="list-style-type: none"> ● Enable: The adjustment period and step set in the SmartLogger are used. Generally, the adjustment period and step are calculated based on the number of devices connected to the port and device specifications. ● Disable: Use this value based on site requirements.

Working Mode	Parameter	Description
	Adjustment period ^[1]	This parameter is displayed after Adaptive adjustment parameters is set to Disable . You can set this parameter based on site requirements. In this case, battery control is performed based on the preset period.
	PV adjustment step ^[1]	This parameter is displayed after Adaptive adjustment parameters is set to Disable . You can set this parameter based on site requirements. In this case, the PV rise step for PV+ESS equalization is the preset value.
TOU	Preferred use of surplus PV power	<ul style="list-style-type: none"> ● Charge: When the PV power is greater than the load power, the surplus PV energy is used to charge the batteries. After the maximum charge power is reached or the batteries are fully charged, the surplus PV energy is fed to the grid. ● Fed to grid: When the PV power is greater than the load power, the surplus PV energy is preferentially fed to the grid. When the maximum output power of the device is reached, the surplus energy is used to charge the batteries. This setting is applicable to the scenario where the FIT is higher than the electricity price. The grid cannot charge the batteries.

Working Mode	Parameter	Description
	Maximum power for charging batteries from grid	Set the maximum power at which the grid charges the batteries.
	Active power threshold of grid during battery discharge	Set the grid power threshold at the grid connection point for loads when the load power is greater than the PV power.
	Adjustment deadband	Set the precision of the grid power at the grid connection point. This parameter affects the power value range at the grid connection point. If the actual grid power threshold at the grid connection point is within this range, i.e. [Maximum grid power during battery discharge – Adjustment deadband, Maximum grid power during battery discharge + Adjustment deadband], the grid power requirement at the grid connection point is met.
	Adaptive adjustment parameters^[1]	<p>Set the adjustment period and step parameters for raising the inverter power.</p> <ul style="list-style-type: none"> ● Enable: The adjustment period and step set in the SmartLogger are used. Generally, the adjustment period and step are calculated based on the number of devices connected to the port and device specifications. ● Disable: Use this value based on site requirements.

Working Mode	Parameter	Description
	Adjustment period^[1]	This parameter is displayed after Adaptive adjustment parameters is set to Disable . You can set this parameter based on site requirements. In this case, battery control is performed based on the preset period.
	PV adjustment step^[1]	This parameter is displayed after Adaptive adjustment parameters is set to Disable . You can set this parameter based on site requirements. In this case, the PV rise step for PV+ESS equalization is the preset value.
	Start time	Set the start time and end time of charge and discharge. A maximum of 14 time segments can be set. You can set a cycle by week by clicking the buttons corresponding to Mon. through Sun. in the Repeat box. The buttons are blue by default, indicating being selected. After you click it, the button turns gray.
	End time	
	Charge/Discharge	
Repeat		
TOU (fixed power)	Start time	Set the start time, end time, and power of charge and discharge. A maximum of 14 time segments can be set. You can set a cycle by week by clicking the buttons corresponding to Mon. through Sun. in the Repeat box. The buttons are blue by default, indicating being selected. After you click it, the button turns gray.
	End time	
	Charge/Discharge	
	Charge/Discharge power (kW)	
	Repeat	

Working Mode	Parameter	Description
Charge/Discharge based on grid dispatch	Adaptive adjustment parameters ^[1]	<p>Set the adjustment period and step parameters for raising the inverter power.</p> <ul style="list-style-type: none"> • Enable: The adjustment period and step set in the SmartLogger are used. Generally, the adjustment period and step are calculated based on the number of devices connected to the port and device specifications. • Disable: Use this value based on site requirements.
	Adjustment period ^[1]	This parameter is displayed after Adaptive adjustment parameters is set to Disable . You can set this parameter based on site requirements. In this case, battery control is performed based on the preset period.
	PV adjustment step ^[1]	This parameter is displayed after Adaptive adjustment parameters is set to Disable . You can set this parameter based on site requirements. In this case, the PV rise step for PV+ESS equalization is the preset value.
	Array end-of-charge SOC	The default value is 100%. The default value is recommended. Set this parameter as required.
	Array end-of-discharge SOC	The default value is 5%. The default value is recommended. Set this parameter as required.

Working Mode	Parameter	Description
	Array end-of-charge/ discharge SOC derating	The default value is Disable . The default value is recommended. Set this parameter as required. After this parameter is enabled, the SmartLogger will be derated according to a certain slope to prevent sudden power changes of arrays at the cut-off SOC point.
	Control charge/ discharge time window	The default value is Disable . The default value is recommended. Set this parameter as required. You can set the time segment for charge forbidden, discharge forbidden, charge, and discharge only after the control charge/discharge time window is enabled.
	Start time	Set the start time, end time, and power of charge forbidden, discharge forbidden, charge, and discharge. A maximum of 14 time segments can be set. You can set a cycle by week by clicking the buttons corresponding to Mon. through Sun. in the Repeat box. The buttons are blue by default, indicating being selected. After you click it, the button turns gray.
	End time	
	Charge/Discharge	
	Charge/Discharge power (kW)	
	Repeat	
	Protection against communication disconnection	

Working Mode	Parameter	Description
Custom	ESS discharge start time	Set the start time of battery discharge. During the period from the start time to the end time, the batteries can be charged and can discharge. Beyond the period, the batteries cannot discharge and can only be charged.
	ESS discharge end time	Set the end time of battery discharge. During the period from the start time to the end time, the batteries can be charged and can discharge. Beyond the period, the batteries cannot discharge and can only be charged.
	Adaptive discharge power	<ul style="list-style-type: none">• Enable: PV power supply is preferred. If the PV power is insufficient, the batteries supply power to loads; if the PV power is sufficient, the system outputs at the target value and the surplus PV power is used to charge the batteries.• Disable: Batteries discharge based on the discharge power set on the GUI.
	Reference discharge power	Set the battery discharge power during the discharge period.

Working Mode	Parameter	Description
	Adaptive adjustment parameters^[1]	Set the adjustment period and step parameters for raising the inverter power. <ul style="list-style-type: none"> • Enable: The adjustment period and step set in the SmartLogger are used. Generally, the adjustment period and step are calculated based on the number of devices connected to the port and device specifications. • Disable: Use this value based on site requirements.
	Adjustment period^[1]	This parameter is displayed after Adaptive adjustment parameters is set to Disable . You can set this parameter based on site requirements. In this case, battery control is performed based on the preset period.
	PV adjustment step^[1]	This parameter is displayed after Adaptive adjustment parameters is set to Disable . You can set this parameter based on site requirements. In this case, the PV rise step for PV+ESS equalization is the preset value.
Note [1]: This parameter is added in SmartLogger V300R023C00SPC120 and later versions. This parameter is displayed and needs to be set only when the Smart PCS is connected.		

2. Choose **Settings > Battery Control** to set automatic calibration for battery control.

Parameter	Description
<p>Automatic SOC calibration</p>	<ul style="list-style-type: none"> • If this parameter is set to Enable, automatic charge and discharge calibration is allowed for battery racks. During calibration, the cut-off SOC settings will be ineffective and the response of the charge and discharge power may be impacted temporarily. • If this parameter is set to Disable, automatic charge and discharge calibration is not allowed for battery racks.
<p>Automatic SOC calibration interval^[1]</p>	<p>Set the automatic SOC calibration interval. This parameter is displayed when Automatic SOH calibration is set Enable.</p> <p>If the battery SOC stays in the range of 10% to 99% most of the time, for example, in the microgrid scenario, the recommended online calibration interval is less than or equal to 7 days.</p> <p>If the battery SOC stays in the range of 40% to 60% most of the time, for example, in the frequency regulation scenario, the recommended online calibration interval is less than or equal to 30 days.</p> <p>If the battery SOC stays below 10% or at 100% most of the time, for example, in the peak shaving scenario, the recommended online calibration interval is less than or equal to 180 days.</p>
<p>Automatic SOH calibration</p>	<ul style="list-style-type: none"> • If this parameter is set to Enable, the ESS automatically calibrates the SOH precision and fully charges and discharges each battery rack in turn. • If this parameter is set to Disable, automatic SOH calibration is not allowed for battery racks.
<p>Note [1]: You can set this parameter in SmartLogger V300R023C00SPCXXX and later versions.</p>	

Peak Shaving

In SmartLogger V300R023C00SPC160 and later versions, **Peak Shaving** is displayed only when the feed-in meter is connected in the ESS scenario.

In some areas, electricity fees depend on both volumetric charge and demand charge. The **Peak Shaving** function allows you to lower the peak demand power purchased from the grid during peak hours, reducing electricity fees. In distributed scenarios, the **Peak Shaving** must be used in maximum self-consumption or TOU mode.

Choose **Settings > Battery Control** and set **Peak Shaving**.

Figure 6-70 Setting peak shaving

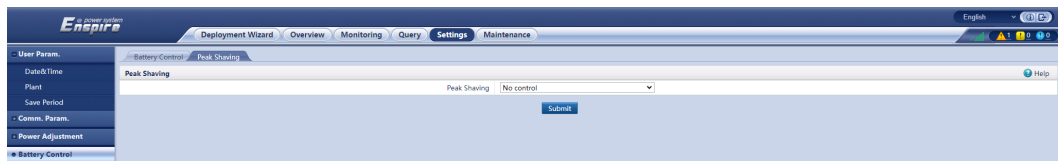

Parameter	Description	Remarks
Peak Shaving	<ul style="list-style-type: none"> No control: The peak shaving function is disabled. Active power limit: The active power purchased from the grid cannot exceed the preset capacity limit. Apparent power limit: The apparent power purchased from the grid cannot exceed the preset capacity limit. 	If Peak Shaving is set to No control , other parameters are not displayed.
Backup power SOC for peak shaving	ESS backup power SOC for peak shaving. The value of this parameter affects the peak shaving capability. A larger value indicates stronger peak shaving capability.	
PV power limit when power meter fails	Set the active power limit of the inverter when the feed-in meter communication is abnormal. You can manually change the active power percentage of the inverter as required.	
PCS power limit when power meter fails	Set the active power limit of the PCS when the feed-in meter communication is abnormal. You can manually change the active power percentage of the PCS as required.	

Parameter	Description	Remarks
Start time	<ul style="list-style-type: none"> Set the peak power range based on the start time and end time. The peak power is configured based on electricity prices in different time segments. You are advised to set the peak power to a low value when the electricity price is high. A maximum of 14 time segments can be set. 	
End time		
Maximum Power		

Capacity Limit

In versions earlier than SmartLogger V300R023C00SPC160, **Capacity Limit** is displayed in the energy storage scenario. Choose **Settings > Battery Control** and set capacity limit.

Figure 6-71 Setting capacity limit

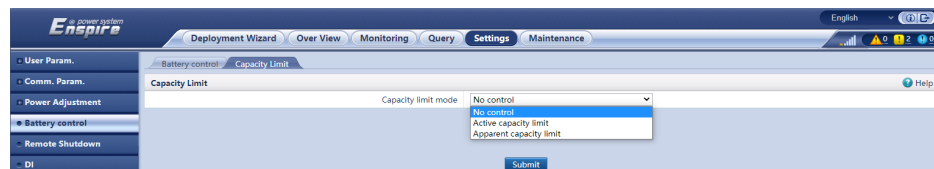

Parameter	Description	Remarks
Capacity Limit	<ul style="list-style-type: none"> No control: The capacity of the grid-connection point is not limited. The inverter and Smart PCS run according to the preset control policy. Active capacity limit: The active power of the grid-connection point for purchasing or feeding power cannot exceed the preset capacity limit. Apparent capacity limit: The apparent power of the grid-connection point for purchasing or feeding power cannot exceed the preset capacity limit. 	If Capacity Limit is set to No control , other parameters are not displayed.
Maximum active capacity	Set this parameter according to the charging capacity in the demand contract of the grid company. Once set, the active power of the grid-connection point for purchasing or feeding power cannot exceed the preset value.	This parameter is displayed only when Capacity Limit is set to Active capacity limit .

Parameter	Description	Remarks
Maximum apparent capacity	Set this parameter according to the charging capacity in the demand contract of the grid company. Once set, the apparent power of the grid-connection point for purchasing or feeding power cannot exceed the preset value.	This parameter is displayed only when Capacity Limit is set to Maximum apparent capacity .
PV power limit when power meter fails	Set the active power limit of the inverter when the feed-in meter communication is abnormal. You can manually change the active power percentage of the inverter as required.	-
PCS power limit when power meter fails	Set the active power limit of the PCS when the feed-in meter communication is abnormal. You can manually change the active power percentage of the PCS as required.	-

NOTE

- If the capacity limit is met 24 hours a day, the ratio of the ESS and Smart PCS power to the load power must be properly set to ensure that the ESS and Smart PCS have sufficient capacity to meet the capacity limit.
- When the ESS is used only for capacity limit, you can set the charge window to 24 hours by setting **TOU** without setting the discharge window or non-charge/discharge window.
- When the capacity limit is enabled in **TOU** mode, the charge/discharge time set in the **TOU** window must cover 24 hours a day. Capacity limit is not supported in non-charge/discharge time.
- The overload capability of transformers, power distribution switches, and cables must be greater than the sum of the maximum charge current and maximum load current of the ESS.

Battery Parameters

If the PCS is powered off, you are advised to preset PCS running parameters on this tab page.

Choose **Settings > Battery Control > Battery parameters** to set PCS parameters in batches. This tab page is displayed only in SmartLogger V300R023C10SPC200 and later versions.

After **Array parameter synchronization** is set to **Enable**, if **Auto switching between working modes**, **Working mode switching delay**, **Working mode** and **VSG** parameters are set and submitted, the corresponding parameters under **Monitoring > PCS > Running Param.** are read-only.

Parameter	Description	Remarks
Array parameter synchronization	<p>The default value is Disable.</p> <p>Disable: The function of array parameter synchronization is disabled. Parameters related to the array are not displayed.</p> <p>Enable: The function of array parameter synchronization is enabled. If the parameter values of the PCS are different from those configured on this page, the parameter values configured on this page will be synchronized for the PCS.</p>	<p>Other battery parameters are displayed only when Array parameter synchronization is set to Enable.</p>
Auto switching between working modes	<p>The default value is Disable.</p> <p>Disable: The function of auto switching between working modes is disabled.</p> <p>Enable: The PCS working mode is automatically switched between PQ and VSG.</p>	<p>When the Auto switching between working modes is set to Enable, the Working mode and VSG-related parameters are not displayed.</p>

Parameter	Description	Remarks
Working mode switching delay	The default value is 60 . Time for other instructions to take effect during PCS working mode switching The value of this parameter ranges from 10s to 300s.	-
Working mode	The default value is PQ . PQ: In the on-grid scenario, set this parameter to PQ . VSG: In the off-grid scenario, set this parameter to VSG .	-

Parameter	Description	Remarks
Per unit armature resistance	The default value is 2 . Specifies the resistance per unit value for armature windings of the virtual synchronous generator. The value of this parameter ranges from 0.0% to 5.0%.	<ul style="list-style-type: none"> This parameter is displayed when Working mode is set to VSG. This parameter must be set by professional personnel. Improper
Per unit armature inductive reactance	The default value is 1 . Specifies the inductive reactance per unit value for armature windings of the virtual synchronous generator. The value of this parameter ranges from 0.0% to 5.0%.	
VSG inertia time constant	The default value is 1 . Specifies the time required for the virtual rotor of the virtual synchronous generator to reach the rated speed from the static state under the rated torque. The value of this parameter ranges from 0.0s to 20.0s.	
P-F adjustment coefficient	The default value is 1 . Specifies the frequency deviation corresponding to the rated active power of the virtual synchronous generator. The value of this parameter ranges from 0.5% to 5.0%.	
Q-V adjustment coefficient	The default value is 3 . Specifies the voltage deviation corresponding to the rated reactive power of the virtual synchronous generator. The value of this parameter ranges from 0.3% to 10.0%.	
P-V adjustment coefficient	The default value is 0 . Specifies the voltage deviation corresponding to the rated active power of the virtual synchronous generator. The value of this parameter ranges from 0% to 10.0%.	
Q-F adjustment coefficient	The default value is 0 . Specifies the frequency deviation corresponding to the rated reactive power of the virtual synchronous generator. The value of this parameter ranges from 0.5% to 5.0%.	
VSG output voltage correction coefficient	The default value is 100 . Corrects the deviation caused by the transformer ratio error. The value of this parameter ranges from 90.0% to 110.0%.	
VSG output frequency correction coefficient	The default value is 100 . Corrects the PCS output frequency deviation. The value of this parameter ranges from 90.0% to 110.0%.	
VSG frequency damping coefficient	The default value is 7.2 . Specifies the power factor that prevents the frequency change of the virtual synchronous generator. The value of this parameter ranges from 1.0% to 10.0%.	

Parameter	Description	Remarks
VSG excitation time constant	The default value is 0 . Specifies the time required for the excitation of the virtual synchronous generator to reach the rated voltage. The value of this parameter ranges from 0s to 100s.	set tin gs ma y ca us e de vic e exc ept ion s.
VSG excitation damping coefficient	The default value is 0 . Specifies the power factor that prevents the voltage change of the virtual synchronous generator. The value of this parameter ranges from 0% to 20000%.	
Active power (%)	The default value is 100 . Adjusts the active power output of the device by percentage. The value of this parameter ranges from -100.0% to 100.0%.	This para meter is delive red once befor e the PCS is starte d. The config uratio n can be modif ied by choos ing Moni torin g > PCS > Runni ng Para m.
Reactive power compensation (Q/S)	The default value is 0 . Specifies the reactive power of the device. The value of this parameter ranges from -100.0% to 100.0%.	

6.5 Setting EMS Control Parameters

This section does not apply to V300R001C00SPC603 and later versions.

Procedure

To set the battery working mode, choose **Settings > EMS Control**.

Figure 6-72 Working mode

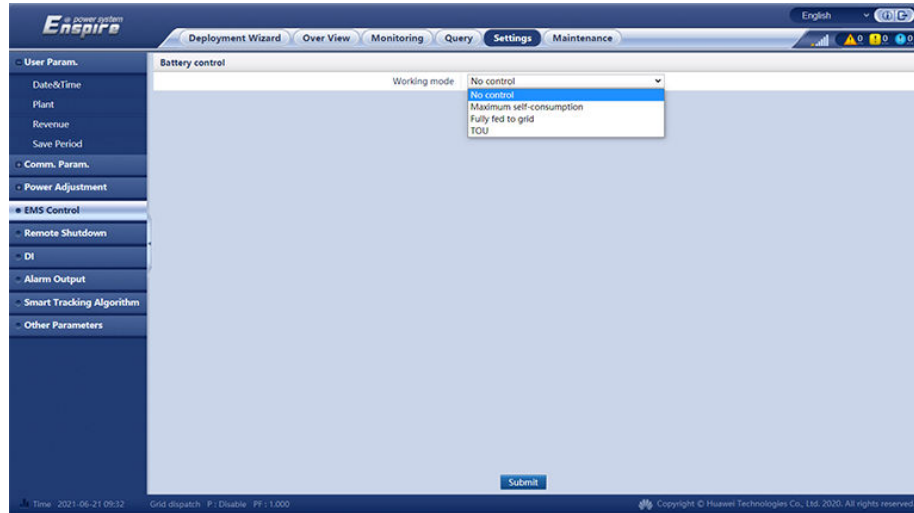

Table 6-18 Battery control working modes

Working Mode	Mode Description
No control	The SmartLogger directly delivers the external scheduling power limit. No other power scheduling control is performed. The power is automatically controlled by the device.

Working Mode	Mode Description
<p>Maximum self-consumption</p>	<ul style="list-style-type: none"> • This mode applies to areas where the electricity price is high, or areas where the FIT subsidy is low or unavailable. The PV+ESS system generates sufficient PV power for loads and uses the surplus PV power to charge the ESS (if the PV power is insufficient for loads, the TOU mode is recommended). • PV power is preferentially supplied to loads, and the surplus power is used to charge the ESS. If the ESS is fully charged or is being charged at full power, the surplus power is fed to the grid. When PV power is insufficient or no PV power can be generated at night, the ESS discharges power to loads. This improves the self-consumption rate and energy self-sufficiency rate, and reduces electricity costs. The grid cannot charge the ESS but can supply power to loads. • The SmartLogger performs ESS scheduling based on the external scheduling power limit and the preceding policies.
<p>Fully fed to grid</p>	<ul style="list-style-type: none"> • This parameter applies only to distributed scenarios. • This mode maximizes the PV energy fed to the grid. When the PV output power in the daytime is greater than the maximum output capacity of the inverter, the surplus PV power is used to charge the ESS. When the PV output power is less than the maximum output capacity of the inverter, the ESS discharges energy to the inverter to maximize the energy fed from the inverter to the grid. The grid cannot charge the ESS. • The SmartLogger directly delivers the external scheduling power limit.

Working Mode	Mode Description
<p>TOU</p>	<ul style="list-style-type: none"> ● It is applicable to the PV+ESS system and ESS-only system where peak to valley electricity prices are different and power meters are available. ● You can manually set the charge and discharge time segments. For example, if you set the low electricity price period at night as the charge time, the system charges the batteries at the maximum power during the charge time. If you set the high electricity price period as the discharge time, batteries can discharge only during the discharge time based on the actual load power, reducing electricity costs. ● Click Add to set the charge and discharge time segments. A maximum of 14 time segments can be set. During the charge time, the grid can charge the batteries. During the discharge time, the batteries can supply power to the loads. In other time segments, the batteries do not discharge. The PV system and grid supply power to loads, and the PV system can charge the batteries. ● In some countries, the grid is not allowed to charge batteries. In such case, this mode cannot be used. ● The SmartLogger performs battery scheduling based on the external scheduling power limit and the preceding policies.

Table 6-19 Running parameters in each battery control working mode

Working Mode	Parameter	Description
Maximum self-consumption	Tracking load	<ul style="list-style-type: none"> • Enable: The device output changes with the load so that the output is approximately equal to the load. • Disabled: The device outputs power as much as possible. However, the output power is still affected by parameters such as external scheduling.
	Battery reverse current protection	<ul style="list-style-type: none"> • Enable: If the battery feeds power to the grid while discharging, the system sends a standby command to the battery to eliminate the reverse power. When the battery needs to discharge power, the system sends a running command to the battery. • Disabled: If reverse battery power is detected at the grid-connection point, the reverse power is eliminated by reducing the battery output power. The battery standby command is not delivered.
	Active power threshold of grid during battery discharge	Set the grid power threshold at the grid connection point for loads when the load power is greater than the PV power.
	Adjustment deadband	Set the precision of the grid power at the grid connection point. This parameter affects the power value range at the grid connection point. If the actual grid power threshold at the grid connection point is within this range, i.e. [Maximum grid power during battery discharge - Adjustment deadband, Maximum grid power during battery discharge + Adjustment deadband], the grid power requirement at the grid connection point is met.

Working Mode	Parameter	Description
TOU	Tracking load	<ul style="list-style-type: none"> ● Enable: The device output changes with the load so that the output is approximately equal to the load. ● Disabled: The device outputs power as much as possible. However, the output power is still affected by parameters such as external scheduling.
	Battery reverse current protection	<ul style="list-style-type: none"> ● Enable: If the battery feeds power to the grid while discharging, the system sends a standby command to the battery to eliminate the reverse power. When the battery needs to discharge power, the system sends a running command to the battery. ● Disabled: If reverse battery power is detected at the grid-connection point, the reverse power is eliminated by reducing the battery output power. The battery standby command is not delivered.
	Preferred use of surplus PV power	<ul style="list-style-type: none"> ● Charge: When the PV power is greater than the load power, the surplus PV energy is used to charge the batteries. After the maximum charge power is reached or the batteries are fully charged, the surplus PV energy is fed to the grid. ● Fed to grid: When the PV power is greater than the load power, the surplus PV energy is preferentially fed to the grid. When the maximum output power of the device is reached, the surplus energy is used to charge the batteries. This setting is applicable to the scenario where the FIT is higher than the electricity price. The grid cannot charge the batteries.
	Maximum power for charging batteries from grid	Set the maximum power at which the grid charges the batteries.
	Active power threshold of grid during battery discharge	Set the grid power threshold at the grid connection point for loads when the load power is greater than the PV power.

Working Mode	Parameter	Description
	Adjustment deadband	Set the precision of the grid power at the grid connection point. This parameter affects the power value range at the grid connection point. If the actual grid power threshold at the grid connection point is within this range, i.e. [Maximum grid power during battery discharge - Adjustment deadband, Maximum grid power during battery discharge + Adjustment deadband], the grid power requirement at the grid connection point is met.
	Start time	Set the start time and end time of charge and discharge. A maximum of 14 time segments can be set. You can set a cycle by week by clicking the buttons corresponding to Mon. through Sun. in the Repeat box. The buttons are blue by default, indicating being selected. After you click it, the button turns gray.
	End time	
	Charge/Discharge	
	Repeat	

6.6 Setting Feature Parameters

PCS Insulation Resistance Detection

The PCS insulation resistance detection function periodically triggers PCS startup and shutdown to check whether the system has a risk of low insulation resistance.

Choose **Settings > Feature Parameters** and set the PCS insulation resistance detection parameter. If a dialog box **You are advised to change the insulation resistance detection time to the optimal time (XX:XX)** is displayed, you are advised to click **Confirm**, go to the **Feature Parameters** page, and set **Detection start time** to the optimal time. This policy applies only to the C&I scenario and is supported in SmartLogger V300R023C00SPC172 and later versions.

Table 6-20 Setting parameters related to PCS insulation resistance detection

Parameter	Description
Detection start time ^[1]	It indicates the time when the PCS insulation resistance detection function is enabled. The default value is 02:00.
Note [1]: You can set this parameter in SmartLogger V300R023C00SPC153 and later versions.	

6.7 Power Grid Scheduling

6.7.1 Power Adjustment Description

According to standard requirements, the SmartLogger can reliably adjust power for the connected solar inverters/Smart PCS in real time to ensure that the plant can respond to requirements of the power grid company in a timely manner.

NOTICE

- To ensure that the SmartLogger will deliver scheduling commands to the connected solar inverters or Smart PCS, you must select the active or reactive power control mode before adjusting the active or reactive power for a PV plant.
- If **Active power control mode** is set to **No limit** or **Reactive power control mode** is set to **No output**, the SmartLogger does not send scheduling commands to the connected solar inverters or Smart PCS.

6.7.2 Setting Active Power Control

If the plant has requirements of power limitation, the power grid scheduling personnel should limit the active power or disable all the active power for the plant, that is, to enable the active power derating mode.

- Step 1** Choose **Monitoring > Inverter/PCS > Running Param. > Power Adjustment**. On the page that is displayed, check that **Remote power schedule** is set to **Enable**.
- Step 2** Set the parameters for active power control and click **Submit**.

Figure 6-73 Active power control

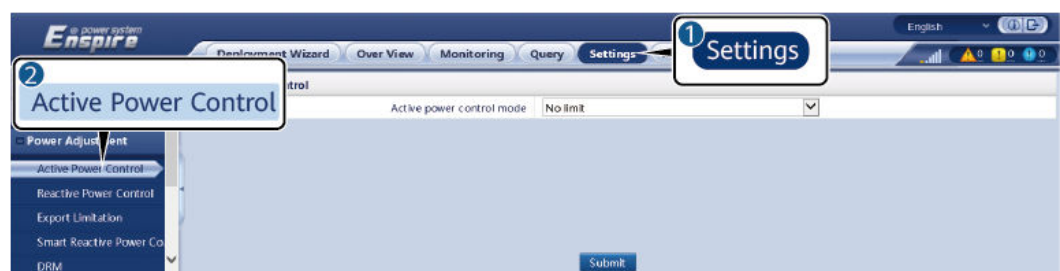

IL04J00008

----End

No Limit

Parameter	Description
Active power control mode	If this parameter is set to No limit , the device operates at full load, and the Smart PCS limits the power based on the energy storage control policy.

DI Active Scheduling

NOTICE

- When setting this function, ensure that the user-defined DI port is not occupied. Otherwise, the setting will fail.
- When setting this function, ensure that the SmartLogger is correctly connected to a ripple control receiver. (In Germany and some other European areas, a ripple control receiver is used to convert a power grid scheduling signal to a dry contact signal, in which a dry contact is needed.)
- When both **Remote communication scheduling** and **DI** are enabled, the control with a lower active power percentage value is preferentially responded.

Parameter	Description
Active power control mode	Set this parameter to DI active scheduling .
Remote communication scheduling	Set this parameter to Start-up , DI active scheduling and remote communication scheduling work at the same time.
DI NOTE DI parameters include DI1, DI2, DI3, DI4 , and Percentage(%) .	<ul style="list-style-type: none">• Sixteen levels are supported for the active power derating percentage.• "-√" indicates a low level. When the four DI ports of the SmartLogger are connected, the ports are low-level ports. When not connected, the ports are high-level ports.• The percentage levels of DI1–DI4 should differ from each other. Otherwise, an abnormal command will be generated.• If the actual input DI signal is inconsistent with that configured on the WebUI, the SmartLogger controls the solar inverter to work at full load and the Abnormal Active Schedule alarm is raised.

Percentage Fixed-Value Limitation (Open Loop)

The SmartLogger provides simplified active power percentage configuration as well as power control automation, that is, to automatically adjust the active power derating percentage in different periods of a day.

Parameter	Description
Active power control mode	Set this parameter to Percentage fixed-value limitation (open loop) to control the maximum output power of the devices by time segment.
Start time	If the device is required to run with specified maximum power in certain periods of a day, add records based on site requirements. When multiple time points are set, the device will run with the maximum power specified for the time point that is earlier than and the closest to the current system time. For example, if you add 00:00:00 and 12:00:00 on the WebUI and the current system time is 14:30:00, the device will run with the maximum power specified for 12:00:00.
Percentage(%)	

Remote communication scheduling

The management system or independent power adjustment device sends scheduling commands over the communications port that supports Modbus-TCP, GOOSE, or IEC104, without the need of user configuration or operation. The SmartLogger can automatically switch between scheduling modes and send scheduling commands.

Parameter	Description
Active power control mode	Set this parameter to Remote communication scheduling . The SmartLogger parses the scheduling command delivered by the upper-layer management system to valid instruction data that can be identified by the devices in the plant and delivers the data to all devices connected to the SmartLogger. As the Remote communication scheduling mode has a higher priority, the SmartLogger automatically changes Active power control mode to Remote communication scheduling after receiving a scheduling command from the upper-layer management system.

Parameter	Description
Schedule strategy	<p>The value can be Disable, Strategy 1, Strategy 2 or Strategy 3. The default value is Strategy 1.</p> <ul style="list-style-type: none"> • Disable: The SmartLogger controls the device to work at full load and will not receive scheduling commands sent by the management system. • Strategy 1: Open-loop scheduling policy. That is, the SmartLogger evenly allocates the power value from the scheduling and delivers the average value to each device, which then operates with the specific power. The adjustment value delivered by the SmartLogger is constant. If Adjustment coefficient is set, the power value will be sent to the device after being multiplied by the preset coefficient. • Strategy 2: Customized functions for specific plants. Set Overshoot, Adjustment period, and Adjustment deadband based on the scheduling requirements of the power plant. <ul style="list-style-type: none"> – Overshoot: Indicates the maximum overshoot percentage during adjustment. If a plant cannot reach the preset target value due to factors such as insufficient sunlight, the set target value is the current value plus the overshoot. – Adjustment period: Indicates the time required from adjustment instruction delivery, device response to the instruction, to the detection of the preceding actions by the SmartLogger. – Adjustment deadband: Indicates the percentage of the adjustment deviation value to the rated output capacity. In the adjustment deadband, strategy 2 does not deliver control instructions but still detects the deviation in real time. • Strategy 3: In the feed-in limitation scenario of the master and slave SmartLoggers, set this parameter to Strategy 3 for the slave SmartLogger.
Adjustment coefficient	Coefficient for calculating the target value of active power adjustment. The default value is 1.000.
Shutdown upon communication exceptions	The default value is Disable . If this parameter is set to Enable , the SmartLogger shuts down the device when the communication between the SmartLogger and the scheduling backend is interrupted for a period longer than the set value of Time for communication exception detection .

Parameter	Description
Time for communication exception detection (s)	The default value is 300 . This parameter is used only for shutdown protection when the communication between the SmartLogger and the scheduling backend is abnormal. If the communication is interrupted for a period longer than the set value, it is determined as abnormal.
Automatic startup upon communication recovery	The default value is Enable . If this parameter is set to Enable , the device automatically starts if the communication recovers after an exception.
Limit solar inverter power upon active power scheduling timeout	The default value is Disable . If this parameter is set to Enable , the SmartLogger controls the device in the following ways after the communication between the SmartLogger and the scheduling backend is interrupted for a period longer than the set value of Active power scheduling timeout threshold for triggering solar inverter power limiting . <ul style="list-style-type: none"> Limit the active power of the inverter based on the value of Power (in percentage of rated power) of solar inverter in case of active power scheduling timeout. Limit the active power of the Smart PCS based on the value of Power (in percentage of rated power) of ESS in case of active power scheduling timeout.
Active power scheduling timeout threshold for triggering solar inverter power limiting (s)	The default value is 300.0 . This parameter is used only for active power limiting protection when the communication between the SmartLogger and the scheduling backend is abnormal. If the communication is interrupted for a period longer than the set value, active power limiting protection is started.
Power (in percentage of rated power) of solar inverter in case of active power scheduling timeout (%)	The default value is 0.0 . After Limit solar inverter power upon active power scheduling timeout is enabled, if the communication between the SmartLogger and the scheduling backend is interrupted for a period longer than the set value of Active power scheduling timeout threshold for triggering solar inverter power limiting , the SmartLogger limits the active power of the inverter based on the set value of this parameter.

Parameter	Description
Power (in percentage of rated power) of ESS in case of active power scheduling timeout (%)	The default value is 0.0 . After Limit solar inverter power upon active power scheduling timeout is enabled, if the communication between the SmartLogger and the scheduling backend is interrupted for a period longer than the set value of Active power scheduling timeout threshold for triggering solar inverter power limiting , the SmartLogger limits the active power of the Smart PCS based on the set value of this parameter.

Export Limitation (kW)

NOTICE

- You are advised to choose **Settings > Export Limitation** and enable the function of limiting feed-in power.
- To enable this function, you need to set meter, inverter/Smart PCS, and export limitation parameters. This section describes how to set export limitation parameters.
- Before setting the parameters, ensure that the power meter is correctly connected to the SmartLogger.

Step 1 Set export limitation parameters and click **Submit**.

Parameter	Description
Active power control mode	Set this parameter to Export Limitation(kW) .
Start control	When this parameter is set to Yes , the power limiting function takes effect.
Electric meter power direction	<ul style="list-style-type: none"> • Positive: default value. <ul style="list-style-type: none"> - Cables are correctly connected to the meter. - If cables are reversely connected to the meter and the NMS does not support reverse connection^[1], set Meter access direction^[2] to Reverse and Electric meter power direction to Positive. • Reverse: applicable to export+import meters. If cables are reversely connected to the meter and the NMS supports reverse connection, set Meter access direction to Reverse_Report raw data and Electric meter power direction to Reverse.

Parameter	Description
Limitation mode	<ul style="list-style-type: none"> • Total power: controls the total power at the grid-connection point to limit the power fed to the power grid. • Single-phase power: controls the power of each phase at the grid-connection point to limit the power fed to the power grid.
Maximum grid feed-in power	<p>Indicates the maximum power that the device can feed into the power grid.</p> <p>Suggestion: Set this parameter based on the feed-in threshold allowed by the power grid company.</p>
Power lowering adjustment period	Specifies the period for lowering the device output power.
Maximum protection time	<p>Specifies the maximum duration from the time when the SmartLogger detects feed-in to the time when the device output power reaches 0.</p> <p>Suggestion: Set this parameter based on the maximum feed-in duration allowed by the power grid company.</p>
Power raising threshold	<p>When the power supply from the grid reaches this threshold, the devices start to raise their output power. The recommended value of this parameter is 1% to 2% of P_n.</p> <p>P_n is the total rated output power of devices and can be queried on the overview page of the SmartLogger.</p>
Fail-safe power threshold	Device output power percentage is controlled by the SmartLogger when communication between the SmartLogger and the meter is abnormal.
Switch-off with 0% power limit	Set whether the DO port is allowed to control switch-off.
Switch-off control port	Set this parameter to the DO port that controls switch-off.
Switch-on control port	Set this parameter to the DO port that controls switch-on.
Switch-off state feedback port	Set this parameter to the DI port that reports the switch-off status.
Switch-on state feedback port	Set this parameter to the DI port that reports the switch-on status.

Parameter	Description
	<p>Note [1]: If cables are reversely connected to the meter and the NMS can correctly display the real-time data of the meter, it is considered that the NMS supports reverse connection. That is, the NMS reverses the active power, reactive power, power factor, phase A active power, phase B active power, and phase C active power, replaces the total positive active energy and total negative active energy with each other, and replaces the total positive reactive power and total negative reactive power with each other.</p> <p>Note [2]: Meter access direction is set in the meter running parameters.</p>

Step 2 Verify that the SmartLogger can remotely turn on and off circuit breakers in scenarios with circuit breakers.

- Click **Switch off** and check that the circuit breaker is switched off properly.
- Click **Switch on** and check that the circuit breaker is switched on properly.

----End

Remote Output Control

NOTE

Remote output control is not supported in energy storage scenarios (excluding distributed energy storage scenarios). When you attempt to set the mode to **Remote output control**, a failure message will be returned. If **Remote output control** has been set before plant expansion by adding ESSs, you need to set **Active power control mode** to other values.

Step 1 Synchronize the clock source of the server.

Path	Parameter	Description
Settings > User Param. > Date&Time	Clock source	Set this parameter to NTP .
	Synchronization server	Set this parameter to the IP address or domain name of the server for time synchronization.
	NTP synchronization test	You can click this button to check the time synchronization status.

Step 2 Set remote output control parameters.

Path	Parameter	Description
Settings > Active Power Control	Active power control mode	Set this parameter to Remote output control .

Path	Parameter	Description
	Control area	Set this parameter to the area where the remote output control function is used. To enable the function in some areas, the license needs to be imported and enabled.
	Output control duration	Set this parameter to the time required for the device to change its output power from 0% to 100% or from 100% to 0%.
	PV plant ID	Set this parameter to the PV plant ID.
	Remote output control server	Set this parameter to the IP address or domain name of the server.
	Enable certificate	Determine whether to import and enable a certificate based on the actual situation.
	Selling surplus power	<ul style="list-style-type: none">● Disable: The inverter output power is controlled by the SmartLogger according to the remote output control command issued by the power company. The output power of the PV plant cannot exceed the active power scheduling value issued by the power company.● Enable: When the load power is less than or equal to the remote output control command, the inverter output power is determined according to the remote output control command. Power can be bought or sold at the grid-connection point. When the load power is greater than the remote output control command, the SmartLogger automatically adjusts the inverter output power to achieve zero-power at the grid-connection point, that is, power cannot be sold at the grid-connection point.
	PV module capacity	Set this parameter to the capacity of PV modules connected to the plant.
	Plant AC capacity	Set this parameter to the AC capacity of the limited feed-in power from the plant.

NOTE

- If the connection between the SmartLogger and the server is abnormal, obtain the output control file in .data format from the website of the power company and import the file.
- After the SmartLogger connects to the server, you can export the relevant file.

----End

6.7.3 Setting Reactive Power Control

Large-scale plants are required to adjust the voltage at the grid-connection point. Power grid scheduling personnel enable a plant to absorb or add reactive power at the grid-connection point, that is, to enable the reactive power compensation, based on the real-time reactive power transmission status in the power grid.

Step 1 Choose **Monitoring > Inverter/PCS > Running Param. > Power Adjustment**. On the page that is displayed, check that **Remote power schedule** is set to **Enable**.

Step 2 Set the parameters for reactive power control and click **Submit**.

Figure 6-74 Reactive power control



----End

No Output

Parameter	Description
Reactive power control mode	If the plant is not required to adjust the voltage at the grid-connection point or perform reactive power compensation, device can run with pure active power output. In this case, set this parameter to No output .

DI Reactive Scheduling

NOTICE

- When setting this function, ensure that the user-defined DI port is not occupied. Otherwise, the setting will fail.
- SmartLogger scenario: Before setting this function, ensure that the SmartLogger is properly connected to the ripple control receiver.
- SmartLogger+SmartModule scenario: Before setting this function, ensure that the SmartModule is properly connected to the ripple control receiver.

Table 6-21 SmartLogger scenario

Parameter	Description
Reactive power control mode	Set this parameter to DI reactive scheduling .
DI NOTE DI parameters include DI1, DI2, DI3, DI4, and Power factor .	<ul style="list-style-type: none">• Sixteen levels are supported for power factors.• "√" indicates a low level. When the four DI ports of the SmartLogger are connected, the ports are low-level ports. When not connected, the ports are high-level ports.• The percentage levels of DI1–DI4 should differ from each other. Otherwise, an abnormal command is generated.• If the actual input DI signal is inconsistent with that configured on the WebUI, the SmartLogger controls the device to work at full power and the Reactive Power Scheduling Instruction Exception alarm is raised.

Table 6-22 SmartLogger+SmartModule scenario

Parameter	Description
Reactive power control mode	Set this parameter to DI reactive scheduling .

Parameter	Description
DI NOTE The DI parameters include M1.DI1, M1.DI2, M1.DI3, M1.DI4, and Percentage.	<ul style="list-style-type: none"> • Supports 16 levels of percentages. • "√" indicates a low level. When the four DI ports of the SmartModule are connected, the ports are low-level ports. When not connected, the ports are high-level ports. • The percentage levels of M1.DI1 to M1.DI4 should differ from each other. Otherwise, an exception will occur during command parsing. If the actual input DI signal is inconsistent with that configured on the WebUI, the SmartLogger controls the device to work at full power and the Reactive Power Scheduling Instruction Exception alarm is raised.

 **NOTE**

- Before connecting the SmartModule to the SmartLogger, if **DI reactive scheduling** has been configured for the DI port and the scheduling signal needs to be connected to the SmartModule, delete the DI configuration and reconfigure it.
- In the scenario where the SmartLogger and SmartModule are combined, if the SmartModule is removed and the scheduling signal needs to be connected to the SmartLogger, delete the DI configuration and reconfigure it.

Reactive Power Fix Control

Parameter	Description
Reactive power control mode	If the PV array is required to generate constant reactive power at a specified time, set this parameter to Reactive power fix control .
Start time	If the device is required to run with specified maximum power in certain periods of a day, add records based on site requirements. When multiple time points are set, the device will run with the maximum power specified for the time point that is earlier than and the closest to the current system time. For example, if you add 00:00:00 and 12:00:00 on the WebUI and the current system time is 14:30:00, the device will run with the maximum power specified for 12:00:00.
Reactive power (kVar)	

Power Factor Fix Control

Parameter	Description
Reactive power control mode	If the plant is required to generate a constant power factor at the grid-connection point and the device is required to adjust the real-time reactive power based on the preset power factor, set this parameter to Power factor fix control .
Start time	If the device is required to run with specified power in certain periods of a day, add records based on site requirements. When multiple time points are set, the device will run with the power specified for the time point that is earlier than and the closest to the current system time. For example, if you add 00:00:00 and 12:00:00 on the WebUI and the current system time is 14:30:00, the device will run with the maximum power specified for 12:00:00.
Power factor	

Q-U Characteristic Curve

If the remote reactive power control command is not available, you can configure the characteristic curve as a substitute. The SmartLogger delivers the values configured for the characteristic curve to the inverter or Smart PCS, which then operates according to the configuration. The SmartLogger no longer adjusts the values.

NOTICE

Configure the characteristic curve under instructions from professionals to ensure that the inverter or Smart PCS works properly.

In the Q-U characteristic curve control mode, the inverter or Smart PCS dynamically adjusts the ratio Q/S of output reactive power to apparent power in accordance with the ratio U/Un(%) of the actual grid voltage to the rated grid voltage.

Parameter	Description
Reactive power control mode	Set this parameter to Q-U characteristic curve .
Reactive power adjustment time	Specifies the change interval of the reactive power for a grid-tied point.
Percents of trigger frequency	Under a specific grid code, the characteristic curve takes effect only when the actual output active power of the device is greater than the specified value.

Parameter	Description
Exit power percentage	Under a specific grid code, the characteristic curve becomes invalid when the actual output active power of the device is less than the specified value.
Limit value for minimum PF	Limits the actual minimum PF when the Q-U characteristic curve takes effect.
Characteristic curve points	Specifies the number of characteristic curve points. The characteristic curve supports a maximum of 10 valid points.
U/Un(%)	When configuring the curve, ensure that the U/Un(%) value of a point is greater than the U/Un(%) value of the previous point. Otherwise, the message indicating invalid input will be displayed.
Q/S	

cos ϕ -P/Pn Characteristic Curve

If the remote reactive power control command is not available, you can configure the characteristic curve as a substitute. The SmartLogger delivers the values configured for the characteristic curve to the inverter or Smart PCS, which then operates according to the configuration. The SmartLogger no longer adjusts the values.

NOTICE

Configure the characteristic curve under instructions from professionals to ensure that the inverter or Smart PCS works properly.

In the cos ϕ -P/Pn characteristic curve control mode, the inverter or Smart PCS dynamically adjusts the power factor cos ϕ in accordance with the P/Pn (%) based on the VDE-4105 and BDEW German standards.

Parameter	Description
Reactive power control mode	Set this parameter to cosϕ-P/Pn characteristic curve .
Reactive power adjustment time	Specifies the change interval of the reactive power at the grid-connection point.
Characteristic curve points	Specifies the number of characteristic curve points. The characteristic curve supports a maximum of 10 valid points.

Parameter	Description
U/Un(%)	When configuring the curve, ensure that the P/Pn(%) value of a point is greater than the P/Pn(%) value of the previous point. Otherwise, the message indicating invalid input will be displayed.
cosφ	

Q-U Hysteresis Curve (CEI0-16)

If the remote reactive power control command is not available, you can configure the characteristic curve as a substitute. The SmartLogger delivers the values configured for the characteristic curve to the inverter or Smart PCS, which then operates according to the configuration. The SmartLogger no longer adjusts the values.

NOTICE

Configure the characteristic curve under instructions from professionals to ensure that the inverter or Smart PCS works properly.

The Q-U hysteresis curve (CEI0-16) control mode is the Italian standard CEI0-16 version of the Q-U characteristic curve. It dynamically adjusts the output reactive power of the inverter or Smart PCS in accordance with the ratio of the actual voltage to the rated voltage. The target value of reactive power adjustment should be in the form of Q/S.

Parameter	Description
Reactive power control mode	Set this parameter to Q-U hysteresis curve(CEI0-16) .
Reactive power adjustment time	Specifies the change interval of the reactive power for a grid-tied point.
Percents of trigger frequency	Under a specific grid code, the characteristic curve takes effect only when the actual output active power of the device is greater than the specified value.
Exit power percentage	Under a specific grid code, the characteristic curve becomes invalid when the actual output active power of the device is less than the specified value.
Limit value for minimum PF	Limits the actual minimum PF when the Q-U characteristic curve takes effect.

Parameter	Description
U/Un(%)	<p>When configuring the curve, ensure that the U/Un(%) value of a point is greater than the U/Un(%) value of the previous point. Otherwise, the message indicating invalid input will be displayed.</p> <p>When configuring the curve, ensure that the Q/S values at points A and B are the same and set in sequence, and that the Q/S values at points C and D are the same and set in sequence. Otherwise, a message indicating invalid input is displayed.</p>
Q/S	

Remote Communication Scheduling

The management system or independent power adjustment device sends scheduling commands over the communications port that supports Modbus-TCP or IEC104, without the need of user configuration or operation. The SmartLogger can automatically switch between scheduling modes and send scheduling commands.

Parameter	Description
Reactive power control mode	<p>As the Remote communication scheduling mode has a higher priority, the SmartLogger automatically changes Reactive power control mode to Remote communication scheduling after receiving a scheduling command from the upper-layer management system.</p> <p>If this parameter is set to Remote communication scheduling, the SmartLogger parses the scheduling command delivered by the upper-layer management system to valid instruction data that can be identified by the devices in the plant and delivers the data to all devices connected to the SmartLogger.</p>
Shut down solar inverter upon reactive power scheduling timeout	<p>The default value is Disable. If this parameter is set to Enable, the SmartLogger shuts down the device when the communication between the SmartLogger and the scheduling backend is interrupted for a period longer than the set value of Reactive power scheduling timeout threshold for triggering solar inverter shutdown.</p>
Reactive power scheduling timeout threshold for triggering solar inverter shutdown	<p>The default value is 300. This parameter is used only for shutdown protection for reactive power scheduling when the communication between the SmartLogger and the scheduling backend is abnormal. If the communication is interrupted for a period longer than the set value, it is determined as abnormal.</p>

Parameter	Description
Start up solar inverter upon recovery from reactive power scheduling timeout	The default value is Enable . If this parameter is set to Enable , after a reactive power signal timeout occurs, if the reactive power signal recovers, the device automatically starts.
Limit solar inverter power upon reactive power scheduling timeout	<p>The default value is Disable. If this parameter is set to Enable, the SmartLogger controls the device in the following ways after the communication between the SmartLogger and the scheduling backend is interrupted for a period longer than the set value of Reactive power scheduling timeout threshold for triggering solar inverter power limiting.</p> <ul style="list-style-type: none"> • Limit the reactive power of the inverter based on the value of Q/S during power limiting of solar inverter in case of reactive power scheduling timeout. • Limit the reactive power of the Smart PCS based on the value of Q/S during power limiting of ESS in case of reactive power scheduling timeout.
Reactive power scheduling timeout threshold for triggering solar inverter power limiting (s)	The default value is 300.0 . This parameter is used only for reactive power limiting protection when the communication between the SmartLogger and the scheduling backend is abnormal. If the communication is interrupted for a period longer than the set value, reactive power limiting protection is started.
Q/S during power limiting of solar inverter in case of reactive power scheduling timeout (%)	The default value is 0.000 . After Limit solar inverter power upon reactive power scheduling timeout is enabled, if the communication between the SmartLogger and the scheduling backend is interrupted for a period longer than the set value of Reactive power scheduling timeout threshold for triggering solar inverter power limiting , the SmartLogger limits the active power of the inverter based on the set value of this parameter.
Q/S during power limiting of ESS in case of reactive power scheduling timeout (%)	The default value is 0.000 . After Limit solar inverter power upon reactive power scheduling timeout is enabled, if the communication between the SmartLogger and the scheduling backend is interrupted for a period longer than the set value of Reactive power scheduling timeout threshold for triggering solar inverter power limiting , the SmartLogger limits the reactive power of the Smart PCS based on the set value of this parameter.

Power Factor Closed-Loop Control (Old Policy)

NOTICE

Before setting the parameters, ensure that the power meter is correctly connected to the SmartLogger.

Parameter	Description
Reactive power control mode	Set this parameter to Power factor closed-loop control (old policy) .
Target power factor	Specifies the target value for the adjustment power factor of the power meter.
Adjustment period	Specifies the interval for sending adjustment commands by the SmartLogger.
Adjustment deadband	Specifies the adjustment power factor precision. NOTICE This parameter is valid only when the power factor of the power meter is greater than 0.9.

Power Factor Closed-Loop Control

To improve the revenue, a distributed plant needs to reduce or avoid the power factor surcharge by performing distributed reactive power compensation. To enable the function, set the related parameters.

NOTICE

- You are advised to choose **Settings > Smart Reactive Power Compensation** to enable smart reactive power compensation.
- For versions earlier than SmartLogger V300R023C00SPC160, before setting the parameters, ensure that the license for smart reactive power compensation has been loaded on the **Maintenance > License Management** page.
- Before setting the parameters, ensure that the power meter is correctly connected to the SmartLogger.

Parameter	Description
Reactive power control mode	Set this parameter to Power factor closed-loop control .

Parameter	Description
Electric meter power direction	<ul style="list-style-type: none"> • Positive: default value. <ul style="list-style-type: none"> – Cables are correctly connected to the meter. – If cables are reversely connected to the meter and the NMS does not support reverse connection^[1], set Meter access direction^[2] to Reverse and Electric meter power direction to Positive. • Reverse: applicable to export+import meters. If cables are reversely connected to the meter and the NMS supports reverse connection, set Meter access direction to Reverse_Report raw data and Electric meter power direction to Reverse.
Power meter	Set this parameter to Smart meter .
Target power factor	Specifies the target value for the adjustment power factor of the power meter. The target value should be larger than the appraisal value of the PV plant power factor.
Adjustment period	Specifies the interval for sending adjustment commands by the SmartLogger.
Adjustment deadband	Specifies the adjustment power factor precision. NOTICE This parameter is valid only when the power factor of the power meter is greater than 0.9.
Reactive compensation delay	Specifies the delay time for starting the distributed power factor compensation if the current power factor is lower than the target power factor.
<p>Note [1]: If cables are reversely connected to the meter and the NMS can correctly display the real-time data of the meter, it is considered that the NMS supports reverse connection. That is, the NMS reverses the active power, reactive power, power factor, phase A active power, phase B active power, and phase C active power, replaces the total positive active energy and total negative active energy with each other, and replaces the total positive reactive power and total negative reactive power with each other.</p> <p>Note [2]: Meter access direction is set in the meter running parameters.</p>	

NOTICE

When the SmartLogger receives a remote reactive power scheduling command from the plant, it automatically changes **Reactive power control mode** to **Remote communication scheduling**. If power factor closed-loop control is required, set **Reactive power control mode** to **Power factor closed-loop control** and set the target power factor correctly.

PF-U Characteristic Curve

If the remote reactive power control command is not available, you can configure the characteristic curve as a substitute. The SmartLogger delivers the values configured for the characteristic curve to the inverter or Smart PCS, which then operates according to the configuration. The SmartLogger no longer adjusts the values.

NOTICE

Configure the characteristic curve under instructions from professionals to ensure that the inverter or Smart PCS works properly.

In the PF-U characteristic curve control mode, the inverter or Smart PCS dynamically adjusts the PF at the device port based on the ratio $U/U_n(\%)$ of the actual grid voltage to the rated grid voltage.

Parameter	Description
Reactive power control mode	Set this parameter to PF-U characteristic curve .
Characteristic curve points	<ul style="list-style-type: none">• Specifies the number of points on the characteristic curve.• The characteristic curve supports a maximum of 10 valid points.
$U/U_n(\%)$	When configuring the curve, ensure that the $U/U_n(\%)$ value of a point is greater than that of the previous point. Otherwise, the "Invalid input" message will be displayed.
PF	

Q-P Characteristic Curve

If the remote reactive power control command is not available, you can configure the characteristic curve as a substitute. The SmartLogger delivers the values configured for the characteristic curve to the inverter or Smart PCS, which then operates according to the configuration. The SmartLogger no longer adjusts the values.

NOTICE

Configure the characteristic curve under instructions from professionals to ensure that the inverter or Smart PCS works properly.

In the control mode of the Q-P characteristic curve, the inverter or Smart PCS adjusts the ratio Q/P_n of the output reactive power to the rated power based on the ratio P/P_n of the current active power to the rated power.

Parameter	Description
Reactive power control mode	Set this parameter to Q-P characteristic curve .
Reactive power adjustment time	Specifies the change interval of the reactive power at the grid-connection point.
Characteristic curve points	<ul style="list-style-type: none"> Specifies the number of points on the characteristic curve. The characteristic curve supports a maximum of 10 valid points.
P/Pn	When configuring the curve, ensure that the P/Pn value of a point is greater than that of the previous point. Otherwise, the "Invalid input" message will be displayed.
Q/Pn	

6.7.4 Setting Parameters For Shutdown at High Feed-in Power

NOTE

This section applies to V300R001C00 only.

The power grid company requires plants to limit or reduce the output power of a PV system when it is too high. If the output power cannot be limited to the range within the specified time, all inverters must be shut down.

Step 1 Set parameters for shutdown at high feed-in power and click **Submit**.

Figure 6-75 Shutdown at high feed-in power

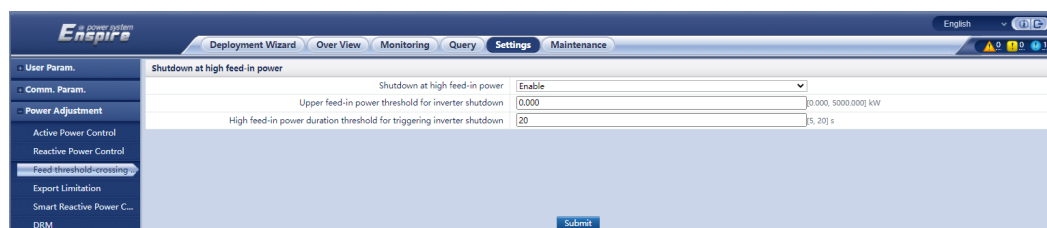

----End

Shutdown at high feed-in power

Parameter	Description
Shutdown at high feed-in power	<ul style="list-style-type: none"> The default value is Disable. If this parameter is set to Enable, the inverter shuts down for protection when the grid-connection point power exceeds the threshold and remains in this condition for the specified time threshold.

Parameter	Description
Upper feed-in power threshold for inverter shutdown	<ul style="list-style-type: none"> The default value is 0. This parameter specifies the power threshold of the grid-connection point for triggering inverter shutdown.
High feed-in power duration threshold for triggering inverter shutdown	<p>The default value is 20. This parameter specifies the duration threshold of high feed-in power for triggering inverter shutdown.</p> <ul style="list-style-type: none"> When High feed-in power duration threshold for triggering inverter shutdown is set to 5, Shutdown at high feed-in power takes precedence. When High feed-in power duration threshold for triggering inverter shutdown is set to 20, Export Limitation(kW) takes precedence (when Active power control is set to Export Limitation(kW)).

6.7.5 Setting Export Limitation Parameters

Context

When the PV and energy storage plant generates power for self-consumption, countercurrent may feed into the power grid if the loads cannot consume all the power. In this case, you can set the export limitation parameters on the WebUI to prevent countercurrent.

- Scenario without a circuit breaker: The reverse current feeding into the power grid can be eliminated by sending a command from the SmartLogger to adjust the inverter/Smart PCS output power.

Figure 6-76 Network diagram (without a circuit breaker)

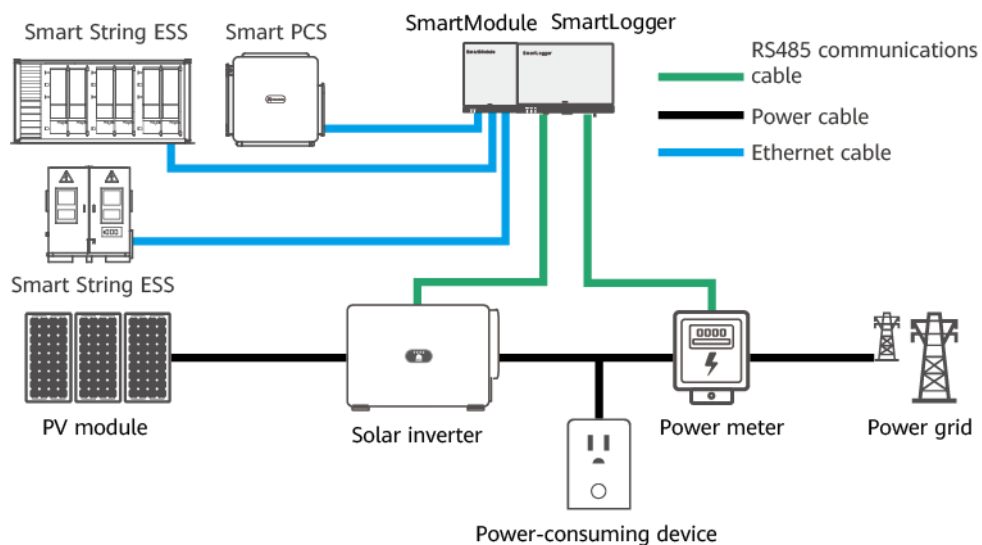

IL04P00002

- Scenario with a circuit breaker: When the reverse current feeding into the power grid cannot be eliminated by sending a command from the SmartLogger to adjust the inverter or Smart PCS output power, and the **Maximum protection time** is exceeded, the SmartLogger drives the relay to switch off the circuit breaker by controlling the DO port. When the DI port detects that the circuit breaker is open, the DO port and relay on the SmartLogger will be switched off, and the SmartLogger will restore to the initial state.

NOTE

Connect the DO ports in series to the 12 V power supply loop of the relay coils. You are advised to use the 12 V power output port on the SmartLogger to power the relay coils. You can also prepare a 12 V power supply.

Figure 6-77 Network diagram (with a circuit breaker)

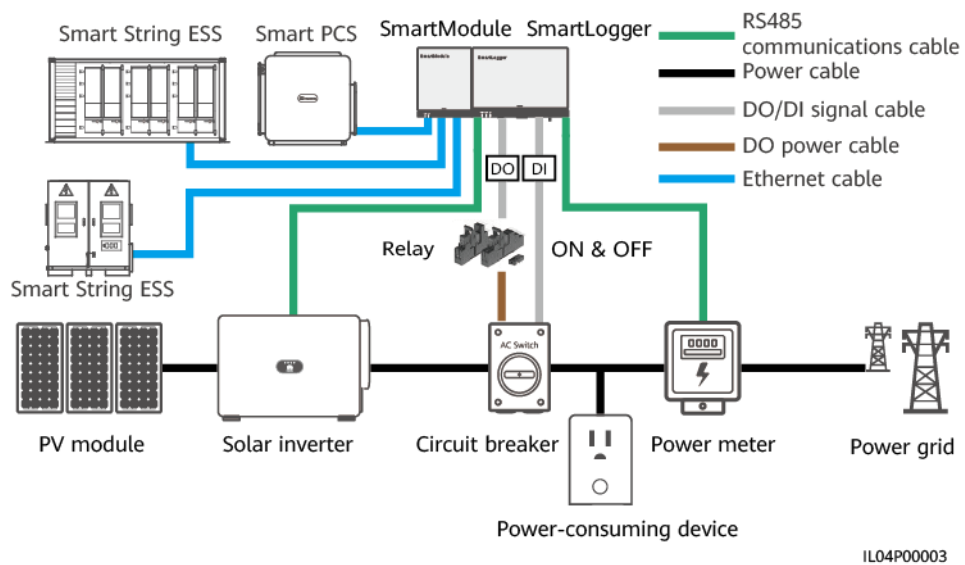

CAUTION

In the scenario with a circuit breaker, place the power supply of the SmartLogger before the circuit breaker to avoid the SmartLogger power-off after the DO switches off the circuit breaker.

Procedure

- Step 1** Set parameters as prompted. For details, click **Help** on the page.

NOTE

- Click **Previous** and **Next** as required.
- For details about the running parameters of power meters, see [6.3.17.2 Setting Modbus-RTU Meter Parameters](#).

Figure 6-78 Setting export limitation parameters

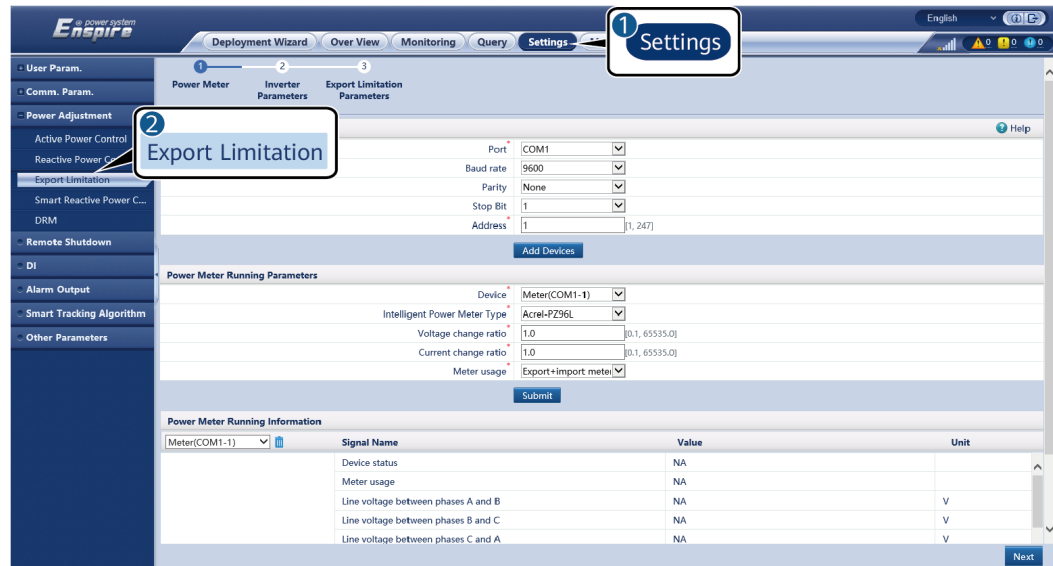

IL04J00011

NOTE

To set Export Limitation Parameters for limited feed-in for the master and slave SmartLoggers, perform the following steps:

1. Set **Inverter Parameters** on all slave SmartLoggers by referring to this section.
2. Choose **Maintenance > Device Mgmt. > Connect Device** on the master SmartLogger to add slave SmartLoggers.
3. Set parameters for **Power Meters, Inverter Parameters, and Export Limitation Parameters** on the master SmartLogger by referring to this section.

----End

6.7.6 Setting Parameters for Smart Reactive Power Compensation

Context

The smart reactive power compensation algorithm obtains the power data of the power meter at the grid-connection point through the SmartLogger, performs intelligent algorithm analysis, adjusts the reactive power output of the solar inverter or Smart PCS, optimizes the power factor of the grid-connection point, and reduces or avoids power factor charge to increase the energy yield of the PV plant.

NOTE

- Before setting the parameters, ensure that the devices are connected to the SmartLogger.
- If a power meter is connected to the SmartLogger, the power meter access procedure in the wizard is only used as a check guide. If no power meter is connected to the SmartLogger, add a power meter by following the wizard.
- For versions earlier than SmartLogger V300R023C00SPC160, before setting the parameters, ensure that the license for smart reactive power compensation has been loaded on the **Maintenance > License Management** page.

Procedure

Step 1 Set parameters as prompted. For details, click **Help** on the page.

Figure 6-79 Setting parameters for smart reactive power compensation (Scenario Selection)



IL04J00014

NOTICE

When the SmartLogger receives a remote reactive power scheduling command from the plant, it automatically changes **Reactive power control mode** to **Remote communication scheduling**. If power factor closed-loop control is required, set **Reactive power control mode** to **Power factor closed-loop control** and set the target power factor correctly.

NOTE

For details about the running parameters of power meters, see [6.3.17.2 Setting Modbus-RTU Meter Parameters](#).

Figure 6-80 Setting parameters for smart reactive power compensation (Power Meter)

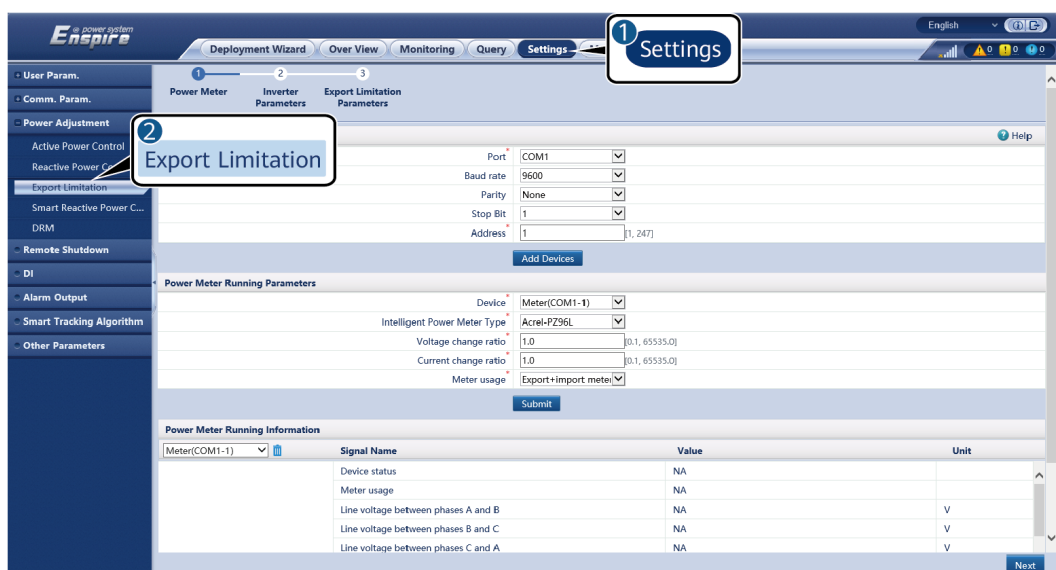

----End

6.7.7 Setting DRM Parameters

Context

According to Australian standards, the inverters must pass the Demand Response Modes (DRM) certification.

Figure 6-81 Wiring diagram for the DRM function

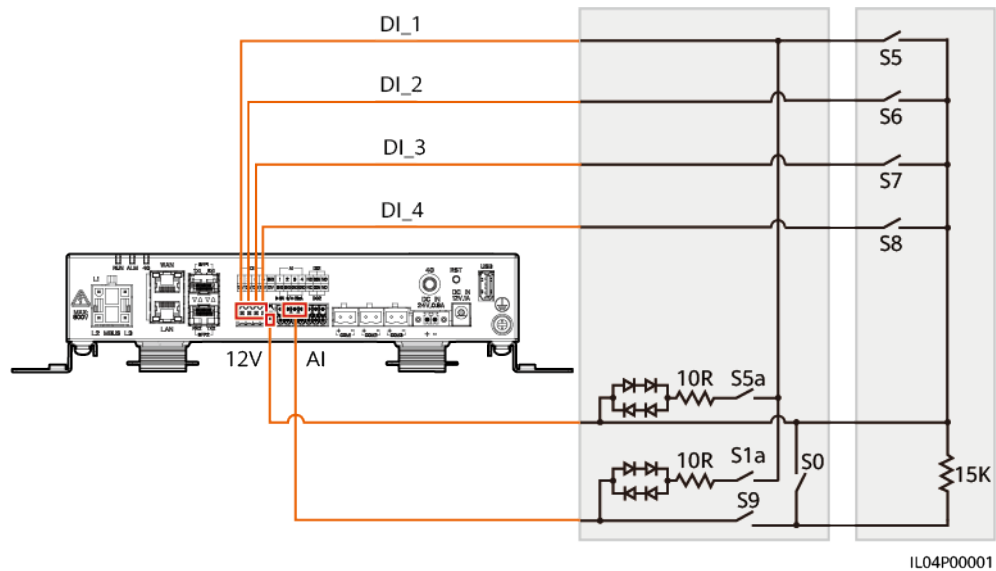

IL04P00001

Table 6-23 DRM requirements

Mode	SmartLogger Port	Requirement	Remarks
DRM0	AI2-AI4	<ul style="list-style-type: none"> When S0 is turned on, the inverters shut down. When S0 is turned off, the inverters are connected to the power grid. 	-
DRM5	DI1	When S5 is turned on, the inverters do not output active power.	When two or more DRM modes are used at the same time, the strictest requirement must be met.
DRM6	DI2	When S6 is turned on, the output active power of the inverters does not exceed 50% of the rated power.	
DRM7	DI3	When S7 is turned on, the output active power of the inverters does not exceed 75% of the rated power, and the inverters consume the maximum reactive power.	

Mode	SmartLogger Port	Requirement	Remarks
DRM8	DI4	When S8 is turned on, the output active power of the inverters recovers. NOTE The inverters output active power based on the percentage set on the SmartLogger.	

Procedure

- Step 1** Choose **Settings > Power Adjustment > Active Power Control** to check the **Active power control mode**.
- When setting DRM0 parameters, you can set **Active power control mode** to any value.
 - When setting DRM5–DRM8 parameters: Set **Active power control mode** to **No limit**.
- Step 2** Choose **Settings > Power Adjustment > Reactive Power Control** and ensure that **Reactive power control mode** is set to **No output**.
- Step 3** Choose **Settings > Remote Shutdown** and ensure that **Access port** is set to **No**.
- Step 4** Set DRM parameters and click **Submit**.

Figure 6-82 Setting DRM parameters

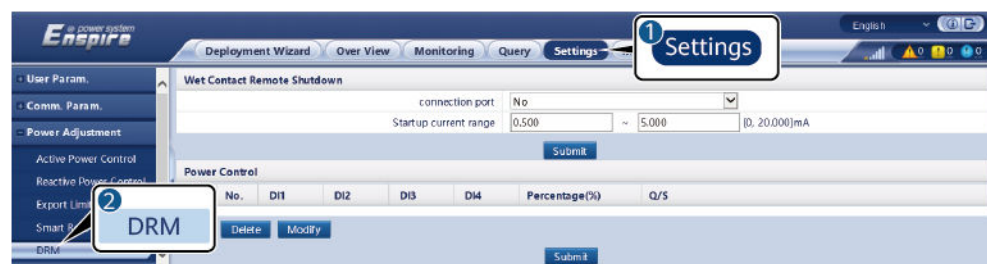

IL04J00015

Parameter	Description
connection port	Set the parameter to the AI port for DRM signals.
Startup current range	If the current of the AI port is within the setting range, inverters are turned on. Otherwise, inverters are turned off.
Power Control	Set DI parameters based on the DRM requirements.

----End

6.7.8 Setting Remote Shutdown

6.7.8.1 Setting Dry Contact Remote Shutdown

Context

The SmartLogger has four DI ports, and the OVGR can connect to any DI port. The SmartLogger shuts down the inverter over OVGR signals.

Figure 6-83 Networking

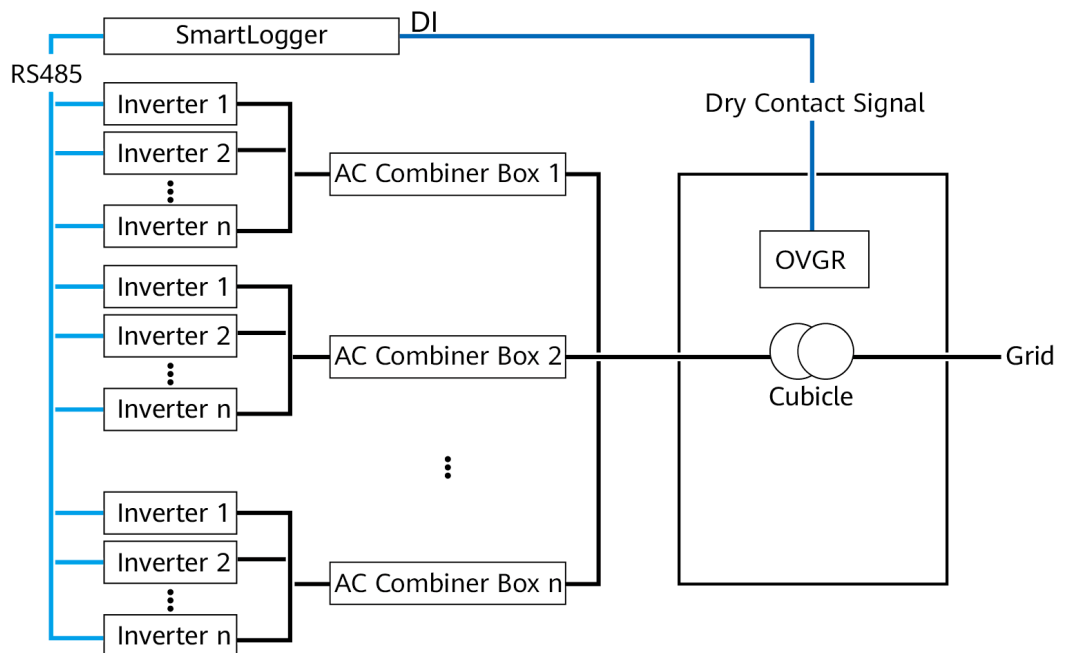

IL01IC3020

NOTICE

When setting this function, ensure that the user-defined DI port is not occupied. Otherwise, the setting will fail.

Procedure

- Step 1** Set dry contact remote shutdown parameters.

Figure 6-84 Dry contact remote shutdown



IL04J00010

Parameter	Description
Access port	Set the parameter to the DI port connected to OVGR signals.
Effective dry contact status	The value can be Open or Close . NOTE If OVGR shutdown is enabled and this parameter is set to Close , the SmartLogger sends an inverter shutdown command only when the corresponding DI port is in the Close state.
OVGR shutdown	Specifies whether to enable shutdown over OVGR.
Cubicle alarm enabling	If this parameter is set to Enable , the Abnormal Cubicle alarm is generated when the dry contact signal is effective and the Cubicle is abnormal.

----End

6.7.8.2 Setting NS Protection Remote Shutdown

Context

- The NS protection function applies to areas complying with the VDE 4105 standard. Choose **Monitoring > Running Param. > Grid Parameters** and set **Grid Code** to **VDE-AR-N-4105** or **SWITZERLAND-NA/EEA:2020-LV230**.
- The NS protection device is connected to the AI1 port and 12V power output port. The SmartLogger shuts down the inverter over the voltage change detected at the AI1 port. When the NS protection device is disconnected, the AI1 port voltage is 0 V, and the inverter shuts down. When the NS protection device is connected again, the AI1 port voltage is 12 V, and you need to start the inverter manually.

Figure 6-85 Networking

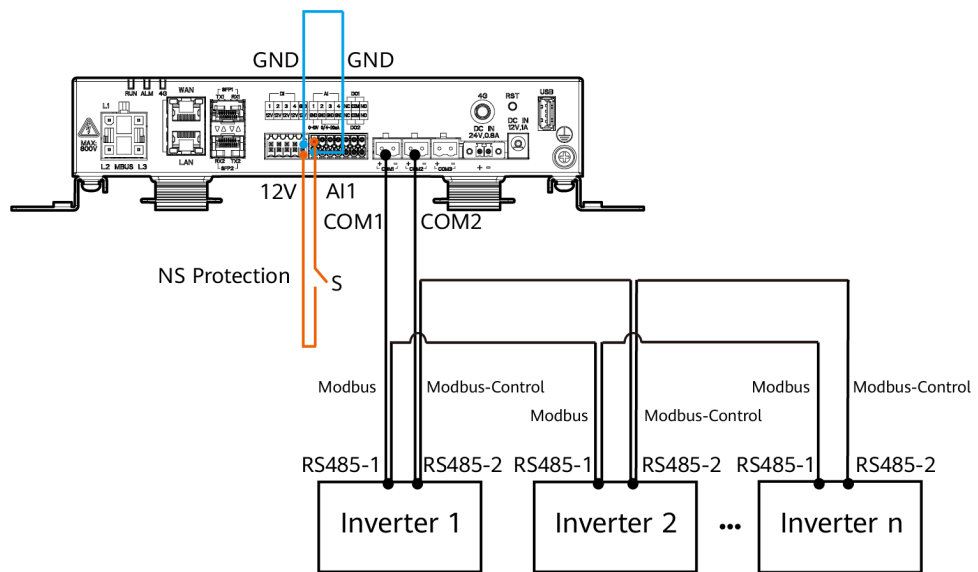

IL04P00006

Procedure

1. Set NS protection remote shutdown parameters.

Figure 6-86 NS protection remote shutdown

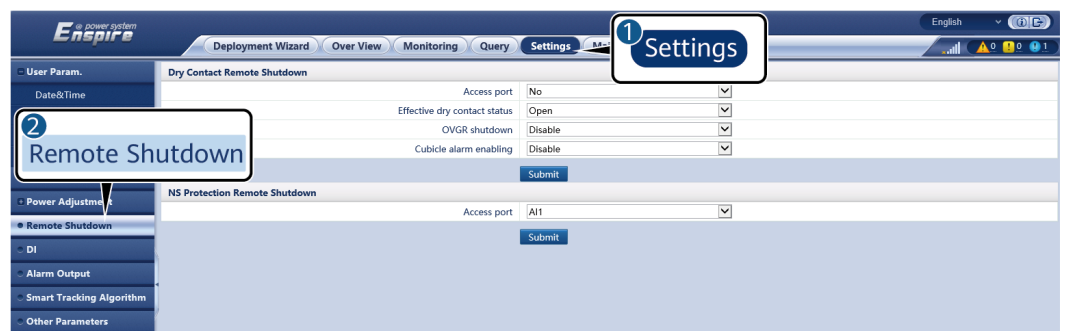

IL04J00010

Parameter	Description
Access port	Set the parameter to AI1 port connected to AI signals. The SmartLogger shuts down the inverter over the voltage change detected at the AI1 port.

2. Set the protocol type of the RS485 communications parameters. **Protocol** of the COM1 port is set to **Modbus** by default, and that of the COM2 port should be set to **Modbus-Control**. Set **Baud rate**, **Parity**, **Stop bit**, **Start address**, and **End address** based on the actual situation.
 - a. If only one inverter is connected to the SmartLogger, connect the COM1 port on the SmartLogger to the RS485-1 port on the inverter, and connect the COM2 port on the SmartLogger to the RS485-2 port on the inverter.

- b. If inverters are cascaded, connect the COM1 port on the SmartLogger to the RS485-1 port on the inverter, and connect the COM2 port on the SmartLogger to the RS485-2 port on the inverter. Connect the RS485-1 and RS485-2 ports on one inverter to the RS485-1 and RS485-2 ports on the other inverter, respectively.

NOTE

Because there are many types of inverters, the RS485-1 port may be named RS485_1, 485B1, or 485A1. The RS485-2 port may be named RS485_2, 485B2, or 485A2.

Figure 6-87 Setting RS485 parameters

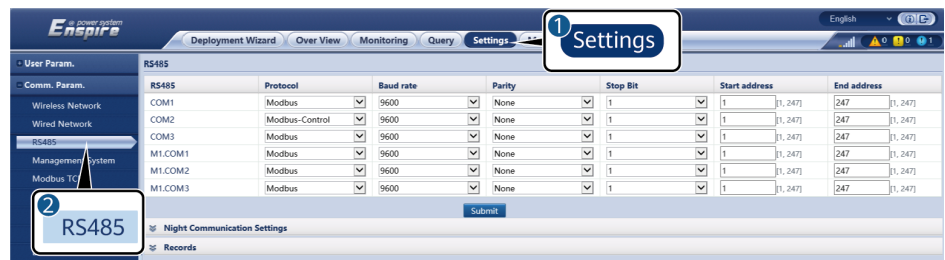

IL03J00082

7 Device Maintenance

7.1 Routine Maintenance

- Ensure that the SmartLogger is free from strong electromagnetic interference.
- Ensure that the SmartLogger is away from heat sources.
- Regularly clean the SmartLogger.
- Regularly check that cables are secured.

7.2 Troubleshooting

No.	Fault	Cause	Suggestions
1	The SmartLogger cannot be powered on.	<ol style="list-style-type: none">1. The DC output power cable for the power adapter is not connected to the 12V IN port of the SmartLogger.2. The power cable is not connected to the AC power input port of the power adapter.3. The AC input power cable is not connected to the AC socket.4. The power adapter is faulty.5. The SmartLogger is faulty.	<ol style="list-style-type: none">1. Connect the DC output power cable for the power adapter to the 12V IN port of the SmartLogger.2. Check that the power cable is connected to the AC power input port of the power adapter.3. Check that the power cable is connected to the AC socket.4. Replace the power adapter.5. Contact the dealer or Huawei technical support.

No.	Fault	Cause	Suggestions
2	The SmartLogger cannot find any device.	<ol style="list-style-type: none"> 1. The COM ports are not connected to devices, or the cables are loose, disconnected, or reversely connected. 2. The RS485 communications parameters are not correctly set, and the solar inverter address is beyond the search range preset on the SmartLogger. 3. The devices that cannot be detected automatically, such as the EMI and power meter, are not manually added. 4. There are devices with duplicate addresses. 5. The network port does not connect to any devices or the network cables are loose. 	<ol style="list-style-type: none"> 1. Check the RS485 cable connection. If the cable is loose, disconnected, or reversely connected, reconnect it firmly. 2. Check the RS485 communications parameter settings. Ensure that the baud rate and communication address are set correctly and that the solar inverter address is within the search range of the SmartLogger. 3. Manually add the devices that cannot be detected automatically, such as the EMI and power meter. 4. Addresses are automatically assigned to all devices to ensure that no duplicate address exists. Then restart the automatic search. 5. Check the network cable connection. If the cable is loose, reconnect it firmly. 6. Contact the dealer or Huawei technical support.
3	The communication for MBUS networking failed.	<ol style="list-style-type: none"> 1. The solar inverter and SmartLogger do not support MBUS. 2. The AC power cable is loose, disconnected, or reversely connected. 3. The upstream circuit breaker for the AC power cable is turned off. 4. In MBUS networking, Built-in MBUS or Networking is set to Disable. 5. The SmartLogger is faulty. 	<ol style="list-style-type: none"> 1. Check whether the solar inverter and SmartLogger support MBUS. 2. Check the AC power cable. If it is loose, disconnected, or reversely connected, reconnect it firmly. 3. Check that the upstream circuit breaker for the AC power cable is turned on. 4. Set Built-in MBUS and Networking to Enable. 5. Contact the dealer or Huawei technical support.

No.	Fault	Cause	Suggestions
4	The device status is displayed as disconnected on the SmartLogger.	<ol style="list-style-type: none"> 1. The cable between the solar inverter and the SmartLogger is loose or disconnected. 2. The solar inverter is powered off. 3. The baud rate or RS485 address of the solar inverter is changed. 4. The solar inverter is replaced. 5. The solar inverter is removed and not reconnected. 	<ol style="list-style-type: none"> 1. Check the communications cable and network cable between the device and the SmartLogger. If the cables are loose, reconnect them firmly. 2. Check the solar inverter connection and power on the solar inverter. 3. Check that the baud rate and RS485 address of the solar inverter are set correctly. 4. If any device is replaced, search for the device again or manually add the device. 5. If the device has been removed, perform the Remove Devices operation on the Device Mgmt. page.
5	The EMI fails in communication.	<ol style="list-style-type: none"> 1. The RS485 communications cable between the EMI and the SmartLogger is connected incorrectly, loose, or disconnected. 2. The EMI is not powered on. 3. The EMI and SmartLogger use different RS485 communications parameter settings. 4. The EMI parameters are incorrectly set. 	<ol style="list-style-type: none"> 1. Check the cable connection. If the cable is loose or disconnected, reconnect it firmly. 2. Power on the EMI. 3. Check that the RS485 communications parameters of the EMI are correctly. 4. Log in to the WebUI and ensure that the EMI parameters are set correctly.
6	The SmartLogger cannot communicate with the management system.	<ol style="list-style-type: none"> 1. The SmartLogger is not connected to the PC, or the cable is loose or disconnected. 2. The parameters of the wired or wireless network are incorrectly set. 3. The management system parameters are incorrectly set. 	<ol style="list-style-type: none"> 1. Check that the Ethernet port of the SmartLogger is correctly connected to the PC or a router. 2. Check that the parameters of the wired or wireless network are set correctly. 3. Check that the management system parameters are correctly set.

No.	Fault	Cause	Suggestions
7	The communication for RS485 networking failed.	<ol style="list-style-type: none"> 1. The RS485 communications cable is incorrectly connected, loose, or disconnected. 2. The SmartLogger is not powered on. 3. The RS485 communications parameters are incorrectly set. 	<ol style="list-style-type: none"> 1. Terminal block connection: Check that the RS485 communications cable is connected to the correct port of the terminal block. 2. RJ45 network port connection: Check that the RJ45 connector is properly crimped and that each wire is connected to the correct pin. 3. Check that the RS485 ports of other devices are connected to the correct ports of the SmartLogger. 4. Check the RS485 cable connection. If the cable is loose, disconnected, or reversely connected, reconnect it firmly. 5. Power on the SmartLogger and its connected device. 6. Check the RS485 communications parameter settings. 7. Contact the dealer or Huawei technical support.
8	The 4G communication is abnormal.	<ol style="list-style-type: none"> 1. The SIM card is not inserted or it is in arrears or damaged. 2. The 4G antenna is not tightened or is damaged. 3. The management system parameters and wireless network parameters are incorrectly set. 4. The SIM card registration failed. 	<ol style="list-style-type: none"> 1. Insert or replace the SIM card. 2. Tighten or replace the 4G antenna. 3. Check that the management system parameters and wireless network parameters are set correctly. 4. Contact the SIM card carrier or Huawei technical support.

7.3 Alarm Reference

For details about alarms, see [SmartLogger3000 Alarm Reference](#).

7.4 WebUI Maintenance Operations

7.4.1 Upgrading the Device Firmware Version

Context

You can upgrade the software of the SmartLogger, inverter, Smart PCS, Smart String ESS, MBUS module, or PID module on the WebUI.

Procedure

Step 1 Perform an upgrade.

Figure 7-1 Upgrade

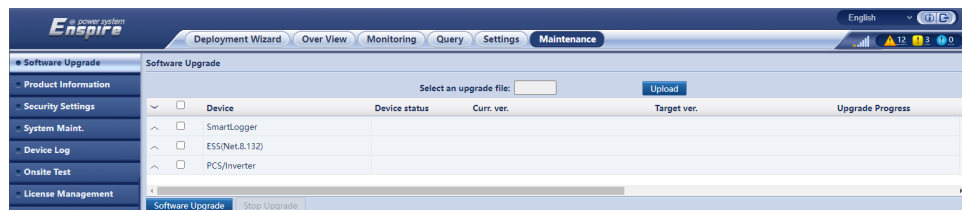

NOTE

- The **Stop Upgrade** function applies only to the devices waiting to be upgraded.
- If the active power control mode is set to **Grid connection with limited power** or **Remote communication scheduling**, and the reactive power control mode is set to **Power factor closed-loop control** or the working mode of **Battery Control** is enabled, you are advised to upgrade software when inverters and Smart PCSs are disconnected from the grid. Otherwise, power control may be abnormal or the upgrade may fail.

----End

7.4.2 Setting Security Parameters

Figure 7-2 Security settings

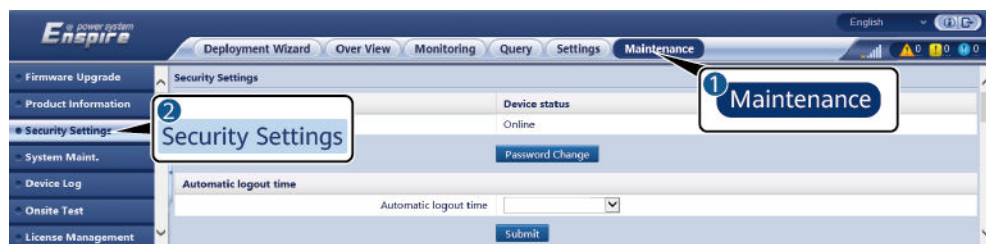

IL03J00038

Parameter	Description
Change Password	Change the password for the current login user to log in to the WebUI.
Automatic logout time	After this parameter is set, a user is automatically logged out if the user does not perform any operation within the period specified by this parameter.

Parameter	Description
WebUI Security Certificate	You are advised to use the existing network security certificate and key.
Update Key	Update the key for saving the password.
SmartModule Security Certificate	Load the network security certificate of the SmartModule. If the private key file has a password, select Enable key password and enter the key password obtained from the certificate provider.
SmartModule Communication Setting	Specifies whether to enable communication using an expired certificate. If this parameter is set to Enable , the SmartLogger can communicate with the SmartModule. After the certificate expires, set this parameter to Disable to prevent the SmartLogger from communicating with the SmartModule to ensure network security.
WEB TLS Setting ^[1]	Enables or disables the TLS1.0 and 1.1 function.
Digital Signature Verification	<ul style="list-style-type: none"> If this parameter is set to Enable, the upgrade package must contain the digital signature file and the upgrade package must not be modified. If this parameter is set to Disable, the digital signature of the upgrade package is not verified.
Intrusion Detection	If this parameter is set to Starting up , when intrusion events such as abnormal user login and key file tampering are detected, you can choose Query > Security Events to query the exception records.
Note [1]: This parameter can be set only for V300R001C00 version.	

7.4.3 Sending a System Maintenance Command

Figure 7-3 System maintenance

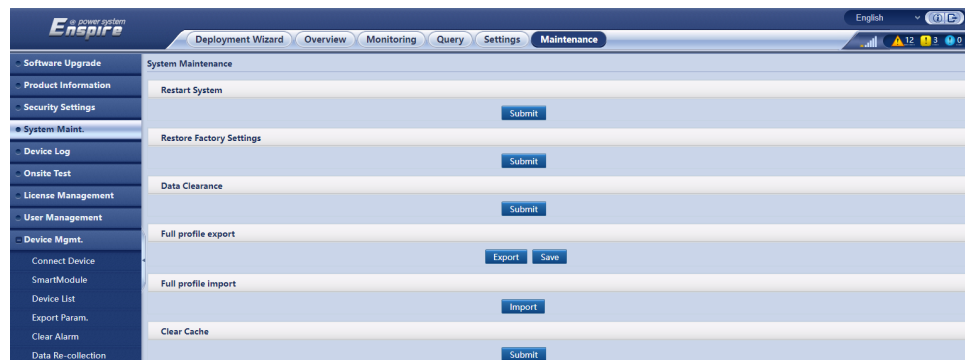

Function	Description
Reset System	Resets the SmartLogger, which will automatically shut down and restart.
Restore Factory Settings	<ul style="list-style-type: none"> Only accounts with the administrator permission (installer) can restore the factory settings. After the factory settings are restored, all configured parameters (except the current date, time, and communication parameters) are restored to their factory default values. The running information, alarm records, and system logs are not changed. Exercise caution when deciding to perform this operation.
Clear Data	Clears all historical data of the SmartLogger.
Full profile export	Before replacing the SmartLogger, export the SmartLogger configuration file to a local PC.
Full profile import	After replacing the SmartLogger, import the local configuration file to the new SmartLogger. After the import is successful, the SmartLogger restarts for the configuration file to take effect. Ensure that the parameters on the Settings tab page and the parameters for the built-in MBUS are correctly set.
Clear Cache	You can clear the temporary files and upgrade package files stored on the SmartLogger through Clear Cache .

7.4.3.1 Exporting Full Configuration Files

Procedure

1. Choose **Maintenance > System Maint.** and click **Export** under **Full profile export**.

 **NOTE**

During the export of the full configuration files, you need to enter **Password of the current user** and set **Encryption password of the exported file** in the **Re-authentication** dialog box.

Figure 7-4 Exporting full configuration files



2. After the export is successful, click **Confirm**. Click **Save** under **Full profile export** to save the full configuration files.

7.4.3.2 Importing Full Configuration Files

Procedure

1. Choose **Maintenance > System Maint.** and click **Import** under **Full profile import**.

NOTE

During the import of the full configuration files, you need to enter **Password of the current user** and **Decryption password of the imported file** in the **Re-authentication** dialog box.

NOTICE

- If **Encryption password of the exported file** has not been set for the exported full configuration files, deselect **Decryption password of the imported file** in the **Re-authentication** dialog box when importing the files.
- If **Encryption password of the exported file** has been set for the exported full configuration files, you need to set **Decryption password of the imported file** in the **Re-authentication** dialog box when importing the files.
- When a faulty SmartLogger3000 is replaced, certificate-related files are not exported. After the full configuration files are imported, you need to reload a third-party certificate if required.

Figure 7-5 Importing full configuration files



2. Click **Choose File**, select all exported files, and click **Import**.

7.4.4 Exporting Device Logs

Procedure

Step 1 Access the device log page.

Figure 7-6 Exporting logs

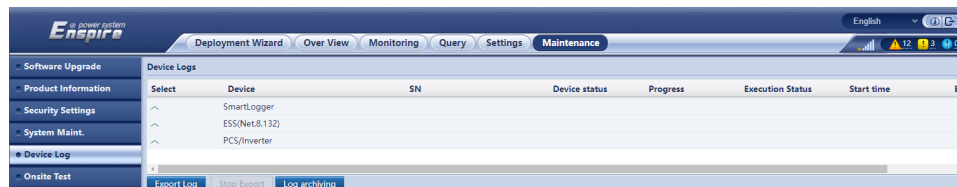

Step 2 Select the device whose logs are to be exported and click **Export Log**.

NOTE

- Logs of two or more types of devices cannot be exported at a time. For example, you cannot select both **SUN2000** and **MBUS**.
- Logs can be exported for a maximum of six devices of the same type at a time.
- Battery Log: Select the device and click **Export Log**. On the Select Upload File Type dialog box that is displayed, select **Battery logs**. You can click the plus sign to select batteries.
- If the active power control mode is set to **Grid connection with limited power** or **Remote communication scheduling**, and the reactive power control mode is set to **Power factor closed-loop control** or the working mode of **Battery Control** is enabled, you are advised to export logs when inverters and Smart PCSs are disconnected from the grid. Otherwise, power control may be abnormal or the log export may fail.
- For an STS connected over RS485, only performance data can be exported, and device logs cannot be exported.

Step 3 Observe the progress bar and wait until the log export is complete.

Step 4 After the export is successful, click **Log archiving** to save the logs.

----End

7.4.5 Starting an Onsite Test

Context

After an inverter is put into use, you need to periodically check its health to detect potential risks and problems.

Procedure

Step 1 Start an onsite test.

Figure 7-7 Onsite test

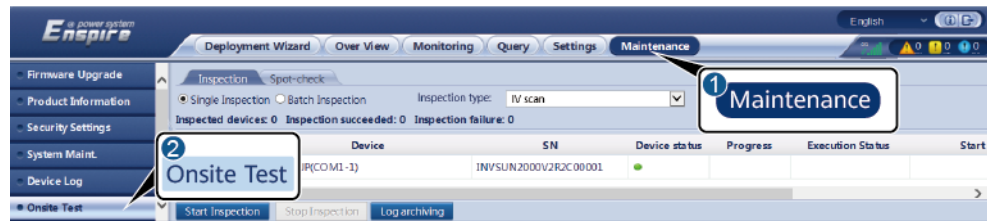

IL03J00041

Tab	Function	Operation Description
Inspection	Check the health status of the inverter.	<ol style="list-style-type: none"> 1. If Single Inspection is selected, select the device to be inspected. If Batch Inspection is selected, you do not need to select a device. 2. Set Inspection type. 3. Click Start Inspection. 4. Observe the progress bar and wait until the inspection is complete. 5. After the inspection is successful, click Log archiving to download the inspection log.
Spot-check	Start a spot-check. NOTE The spot-check function is available only for a device whose grid code is set to the Japanese standard.	<ol style="list-style-type: none"> 1. Select the device to be spot-checked. 2. Click Start Spot-Check. 3. Perform a spot-check test onsite. 4. After the spot-check test is complete, click Stop Spot-Check.

Tab	Function	Operation Description
Alarm Test	Simulates an inverter alarm. NOTE Only the SUN2000-63KTL-JPH0, SUN2000-50KTL/63KTL-JPM0, and SUN2000-125KTL-JPH0 support the alarm test function.	<ol style="list-style-type: none"> 1. Choose Device model > Device name to select the device for which the alarm test is to be performed. 2. Click an alarm name to deliver an alarm command. The alarm icon is green by default and turns red after the command is delivered. 3. Click Clear Alarm to clear all alarms of the SUN2000-63KTL-JPH0, SUN2000-50KTL/63KTL-JPM0, and SUN2000-125KTL-JPH0. NOTE After the alarm is cleared, the SmartLogger collects alarm data again.

----End

7.4.6 License Management

Context

- The Smart I-V Curve Diagnosis, smart string monitoring, and Smart Tracker Control Algorithm (SDS) can be used only after licenses are purchased.
- The license files for Smart I-V Curve Diagnosis and smart string monitoring are stored in the inverter, and the SDS license file is stored in the SmartLogger. Each license uniquely matches a device SN.
- License management allows you to view the inverter license information and obtain the current license status. Before a device is replaced, the current device license needs to be revoked so that a revocation code can be generated and used for applying for a new device license.
- The size of the license file imported to the SmartLogger must be less than 1 MB. Otherwise, the page will be abnormal.
- For versions earlier than SmartLogger V300R023C00SPC160, you need to purchase a license to use the smart reactive power compensation. The license file is stored in the SmartLogger. For SmartLogger V300R023C00SPC160 or later versions, the smart reactive power compensation can be used directly.
- In SmartLogger V300R023C10 and later versions, the LUNA2000-200KTL-H1 supports the off-grid function. The function can be used only after a license is purchased.

Procedure

Step 1 Access the **License Management** page.

Figure 7-8 License management



IL03J00042

Tab	Function	Description
License information	Displays the license information.	<ol style="list-style-type: none"> 1. Select the name of the device whose license details are to be exported. 2. Click Export Details.
License application	Exports the license application file.	<ol style="list-style-type: none"> 1. Select the name of the device whose license file is to be exported. 2. Click Export License Appli File. 3. Purchase a license from Huawei and obtain the license file from Huawei technical support engineers
License loading	Loads the obtained license to the corresponding device.	<ol style="list-style-type: none"> 1. Click Upload License. 2. Select the name of the device whose license is to be loaded. 3. Click Load License.
License revocation	Revokes a license or exports the revocation code file.	<ol style="list-style-type: none"> 1. Select the name of the device whose license is to be revoked. 2. Click Revoke License. 3. Click Export Revo Code File.

NOTE

When importing a license file, ensure that the file name extension is .dat or .zip.

----End

7.4.7 Managing the SmartModule

Context

When replacing the SmartModule, you need to manually remove the device on the WebUI.

Procedure

1. Choose **Maintenance > Device Mgmt. > SmartModule.**
2. Select the device to be removed and click  to remove it.

NOTE



is used to change the secondary authentication password of the SmartModule.

7.4.8 Managing Users

Context

- After the SmartLogger is upgraded from V300R001C00, **installer** has the administrator permission, and **admin** becomes an advance user.
- You can add, modify, and delete users after logging in as **installer**.

Procedure

- Step 1** Add a user.

Figure 7-9 Adding a user

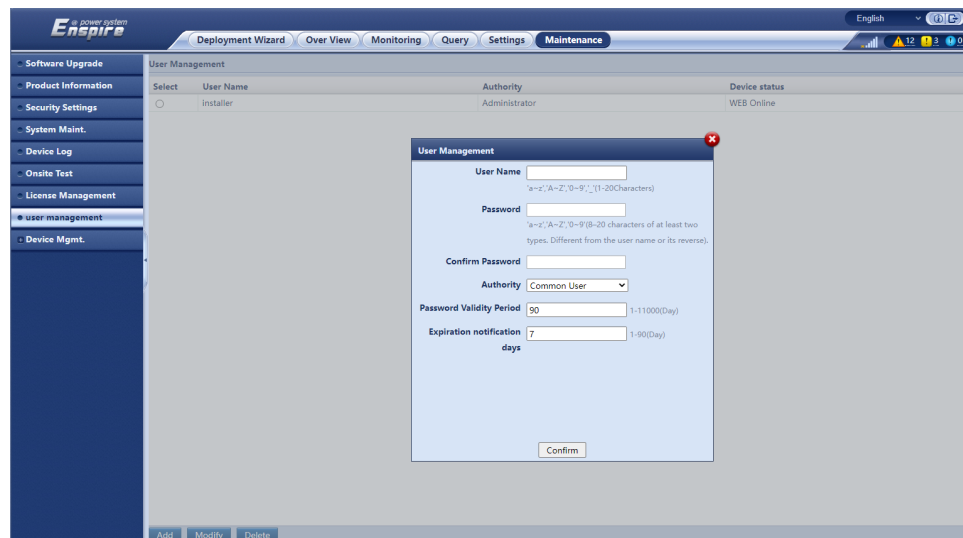

- Step 2** Modify a user.

Figure 7-10 Modifying a user

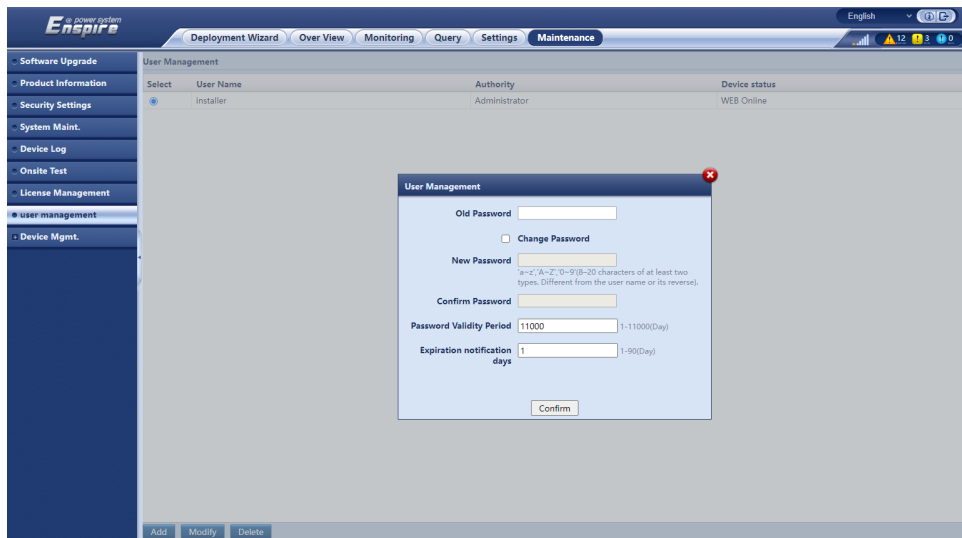

Step 3 Delete a user.

Figure 7-11 Deleting a user

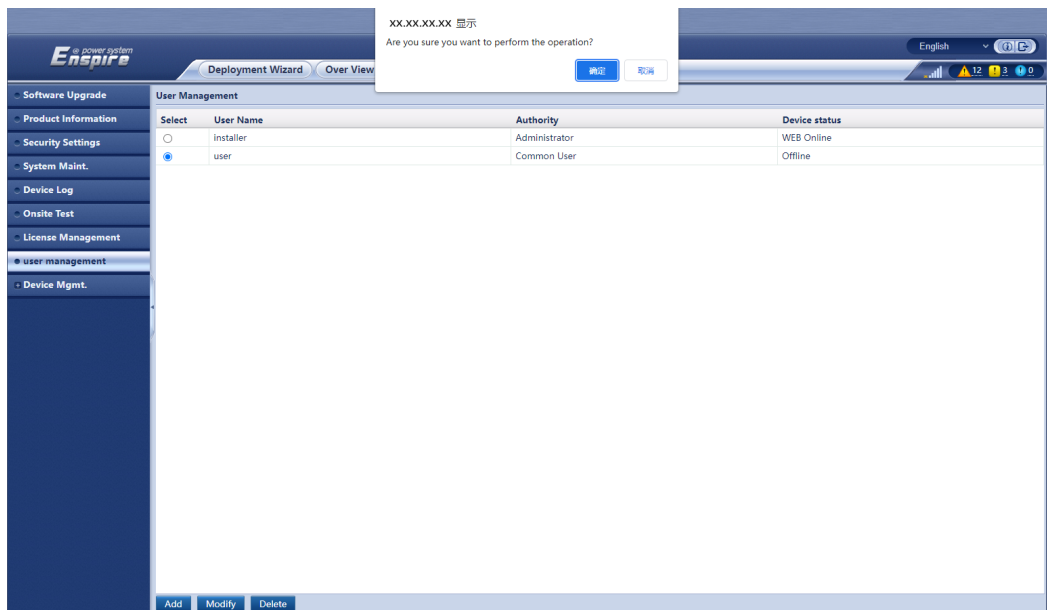

----End

7.4.9 Collecting Performance Data

Context

You can re-collect performance data of the solar inverter, Smart PCS, CMU, and ESU as well as daily, monthly, and yearly energy yields (also referred to as data re-collection).

Procedure

- Step 1** Choose **Maintenance > Device Mgmt. > Data Re-Collection**.
 - Step 2** Select the type of the data to be collected and set the collection period.
 - Step 3** Select the name of the device whose data is to be collected and click **Collect Data**.
 - Step 4** Wait until all data is gathered. On the **Monitoring** page, query the collection result.
- End

7.4.10 Adjusting the Total Energy Yield

This section applies to V300R001C00.

Procedure

- Step 1** Choose **Maintenance > Device Mgmt. > Adjust total energy yield**.
 - Step 2** Set **Adjust total energy yield(kWh)**, select the name of the device whose total energy yield needs to be adjusted, and click **Submit**.
- End

7.4.11 Force Start

This section does not apply to V300R001C00.

Context

- The force start function is mainly used in the scenario where the ESS cannot be deployed due to long-time low battery voltage and batteries need to be charged.
- During the force start operation, each Smart PCS charges the ESS at 50 kW power. Ensure that the AC power meets the requirement. If the AC power is restricted, you are advised to charge the ESS in batches and disconnect the auxiliary power supply and power circuits of the devices that do not need to be charged.
- To use the force start function, prepare an external power supply for the system and set **Working mode** to **PQ** under **Monitoring > PCS > Running Param. > Feature Parameters**.
- When you force start the ESS, the ESS functions are restricted because no deployment operation is performed. In this case, the ESS supports only battery charging and cannot be scheduled by the upper-layer controller.

Procedure

- Step 1** Choose **Maintenance > Device Mgmt. > Force Start** and click **Starting up**. This operation will interrupt ongoing services in the array. Exercise caution when performing this operation.

Step 2 Start the insulation resistance detection procedure. If the detection is successful, force start is initiated. Otherwise, force start fails. The overdischarge insulation resistance function is supported only in SmartLogger V300R023C00SPC172 and later versions and applies only to the C&I scenario.

 **NOTE**

- The array-level force start operation lasts 180 minutes. The SmartLogger needs to maintain the array-level force start state. The default status is idle. After a force start task is started, the SmartLogger periodically collects the SOC value of each battery rack. If the SOC value is lower than 50%, the SmartLogger remains in the **Force starting...** state. If the SOC value of each battery rack exceeds 50% or the protection duration for force start exceeds the upper limit, the SmartLogger restores the force start state to idle.
- You can stop a force start task. In this case, devices in the array stop force start and return to the original status. If the system does not need to be started, shut down the system.
- After an array-level force start task is started, if new devices are connected and cannot be automatically started or some devices restart, the SmartLogger delivers a force start command at an interval of 5 minutes to ensure that the devices can identify the force start state.

----End

7.4.12 Device Replacement

Context

The device replacement function applies to the scenario where a faulty CMU is replaced. The SmartLogger can automatically back up CMU parameters. If a CMU is replaced, the SmartLogger allows you to automatically import the backup CMU parameters to the new CMU. The function of CMU parameter backup is only supported in SmartLogger V300R023C10 and later versions, which shall be matched with the version of the ESS software.

- C&I scenario: LUNA2000B V100R023C00SPC120 and later versions.
- Utility-scale scenario: LUNA2000C V100R023C00SPC110 and later versions.

Procedure

1. Choose **Maintenance > Device Mgmt. > Device Replacement**. The device replacement page is displayed.
2. After setting the parameters, click **Submit**.

Parameter	Description
Operate Type	Set Replace Device .
Device Type	Set CMU .
SN of Old Device	SN of the old CMU

Parameter	Description
SN of New Device	SN of the new CMU

7.5 Device Replacement

7.5.1 Exporting Configuration Files from the SmartLogger WebUI

- Step 1** Before replacing the SmartLogger, export its configuration files to a local PC. Perform operations by referring to [7.4.3.1 Exporting Full Configuration Files](#).
- Step 2** Power off the SmartLogger, remove its cables, and label the cables.
- Step 3** Install a new SmartLogger, reconnect the cables, and power on the SmartLogger.
- Step 4** Log in to the WebUI and import the exported configuration files from the local PC to the new SmartLogger. Perform operations by referring to [7.4.3.2 Importing Full Configuration Files](#).
- Step 5** After the import is successful, the SmartLogger restarts for the configuration files to take effect. Ensure that the parameters on the settings tab page and the parameters for the built-in MBUS are correctly set.

----End

7.5.2 Exporting Configuration Files from the SUN2000 App

NOTICE

Do not power off the SmartLogger3000 when exporting all configuration files.

- Step 1** Before replacing the SmartLogger, export its configuration files to a USB flash drive.
1. Insert the USB flash drive into the USB port at the bottom of the SmartLogger3000.
 2. Run the SUN2000 app and select a connection mode. On the operation screen, tap **Manual connection**, and select **WLAN**. The initial name of the WLAN hotspot is **Logger-SmartLogger SN**. You can view the device SN on the SmartLogger3000 label.

 **NOTE**

Use the initial password **Changeme** of the WLAN hotspot for the first login and change it immediately after login. To ensure account security, protect the password by changing it periodically, and keep it secure. Your password might be stolen or cracked if it is left unchanged for extended periods. If a password is lost, devices cannot be accessed. In these cases, the Company shall not be liable for any loss caused to the plant.

3. After connecting the WLAN, log in to the device and access the main menu screen.

 **NOTE**

- When you log in to the device for the first time, set the login password. To ensure account security, protect the password by changing it periodically, and keep it secure. Your password might be stolen or cracked if it is left unchanged for extended periods. If a password is lost, devices cannot be accessed. In these cases, the Company shall not be liable for any loss caused to the plant.
- You will be locked out for 10 minutes after five consecutive failed password attempts (the interval between two consecutive entries is less than 2 minutes).

4. Choose **Maintenance > Export All Files**, set **Encryption password of the exported file**, and tap **Confirm** to export the configuration files.
5. After the export is complete, tap **OK** and remove the USB flash drive.

Step 2 Power off the SmartLogger, remove its cables, and label the cables.

Step 3 Install a new SmartLogger, reconnect the cables, and power on the SmartLogger.

Step 4 Run the SUN2000 app, log in to the new device, and import the configuration files.

1. Insert the USB flash drive into the USB port at the bottom of the new SmartLogger3000.
2. Start the SUN2000 app and log in to the new device. On the operation screen, tap **Manual connection**, and select **WLAN**. The initial name of the WLAN hotspot is **Logger-SmartLogger SN**. You can view the device SN on the SmartLogger3000 label.

 **NOTE**

Use the initial password **Changeme** of the WLAN hotspot for the first login and change it immediately after login. To ensure account security, protect the password by changing it periodically, and keep it secure. Your password might be stolen or cracked if it is left unchanged for extended periods. If a password is lost, devices cannot be accessed. In these cases, the Company shall not be liable for any loss caused to the plant.

3. After connecting the WLAN, log in to the device and access the main menu screen.

 **NOTE**

- When you log in to the device for the first time, set the login password. To ensure account security, protect the password by changing it periodically, and keep it secure. Your password might be stolen or cracked if it is left unchanged for extended periods. If a password is lost, devices cannot be accessed. In these cases, the Company shall not be liable for any loss caused to the plant.
- You will be locked out for 10 minutes after five consecutive failed password attempts (the interval between two consecutive entries is less than 2 minutes).

4. Choose **Maintenance > Import All Files**, enter **Decryption password of the imported file**, and tap **Confirm** to import the configuration files.
5. After the import is complete, tap **OK** and remove the USB flash drive.

Step 5 After the import is successful, the SmartLogger restarts for the configuration files to take effect. Ensure that the parameters on the settings tab page and the parameters for the built-in MBUS are correctly set.

----End

7.6 Device Disposal

If the service life of the SmartLogger expires, dispose of the SmartLogger according to the local disposal act for waste electric appliances.

8 FAQ

8.1 How Do I Connect the SmartLogger to the SUN2000 App or FusionSolar App?

Prerequisites

- The SmartLogger has been powered on.
- The WLAN function has been enabled on the SmartLogger.

NOTE

- By default, **WLAN** is set to **OFF in idle state**.
- When **WLAN** is set to **OFF in idle state**, the WLAN function is available within 4 hours after the SmartLogger is powered on. In other cases, hold down the RST button (for 1s to 3s) to enable the WLAN function.
- If **WLAN** is set to **Always OFF**, choose **Settings > Wireless Network** on the SmartLogger WebUI and set **WLAN** to **Always ON** or **OFF in idle state**.
- The FusionSolar app is recommended when the SmartLogger is connected to the FusionSolar SmartPVMS. The SUN2000 app is recommended when the SmartLogger is connected to other management systems.
- The SUN2000 app or FusionSolar app has been installed on the mobile phone.

Context

- The SUN2000 app or FusionSolar app communicates with the SmartLogger through the WLAN to provide functions such as alarm query, parameter settings, and routine maintenance.
- Mobile phone operating system: Android 4.0 or later
- Access the Huawei app store (<https://appstore.huawei.com>), search for **SUN2000** or **FusionSolar**, and download the app installation package.

Figure 8-1 WLAN connection range

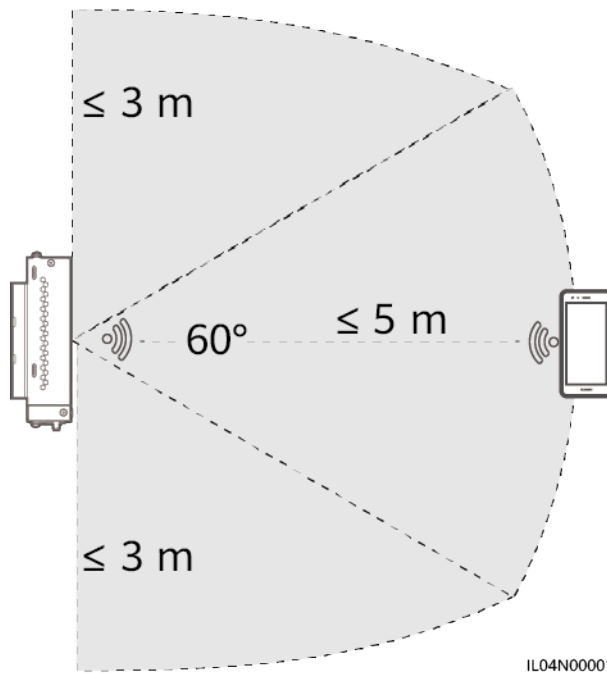

Procedure

Step 1 Log in to the app.

1. (Connecting the SmartLogger to the FusionSolar SmartPVMS) Open the FusionSolar app, log in to intl.fusionsolar.huawei.com as installer account, and choose **Me > Device commissioning** to connect to the WLAN hotspot of the SmartLogger.
2. (Connecting the SmartLogger to Other Management Systems) Open the SUN2000 app and connect to the WLAN hotspot of the SmartLogger.
3. Select **installer** and enter the login password.
4. Tap **Log in** and go to the **Quick Settings** screen or **SmartLogger** screen

NOTE

- The screenshots in this document correspond to the FusionSolar app version 6.22.10.118 (Android) and SUN2000 app version 6.22.10.117 (Android).
- The initial WLAN hotspot name of the SmartLogger is **Logger_SN** and the initial password is **Changeme**. The SN can be obtained from the SmartLogger label.
- The initial passwords of **installer** and **user** are both **00000a** for the SUN2000 app and FusionSolar app device commissioning.
- Use the initial password upon first power-on and change it immediately after login. To ensure account security, change the password periodically and keep the new password in mind. Not changing the initial password may cause password disclosure. A password left unchanged for a long period of time may be stolen or cracked. If a password is lost, the device cannot be accessed. In these cases, the user is liable for any loss caused to the PV plant.
- If the SmartLogger is powered on for the first time or the factory defaults are restored and parameter configuration is not performed on the WebUI, the quick settings screen is displayed after you log in to the app. You can set parameters based on site requirements.

Figure 8-2 Logging in to the app

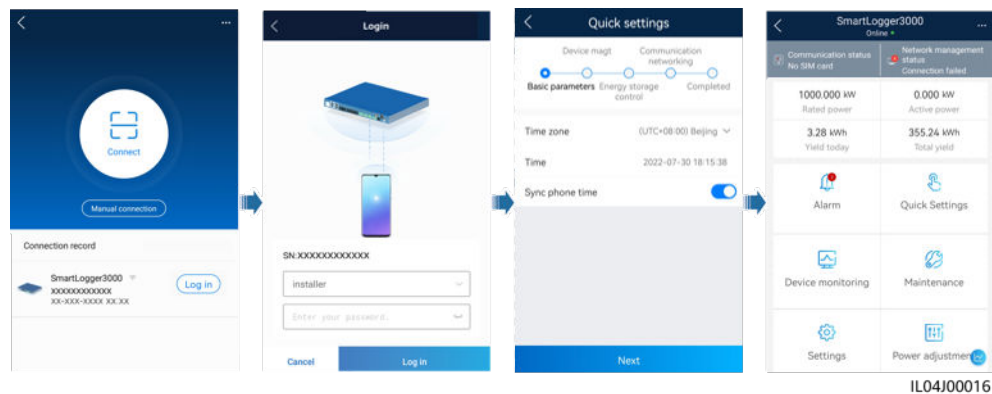

----End

8.2 How Do I Set FTP Parameters?

Context

- The FTP function is used to access a third-party NMS. The SmartLogger can report the configuration information and running data of the managed PV plant system through FTP. A third-party NMS can access Huawei devices after being configured.
- FTP is a universal standard protocol without any security authentication mechanism. Data transmitted by FTP is not encrypted. To reduce network security risks, the IP address of the connected third-party FTP server is left blank by default. This protocol can transmit the running data of PV plants, which may cause user data breach. Therefore, exercise caution when using this protocol. Users are liable for any loss caused by the enabling of the FTP protocol (non-secure protocol). Users are advised to take measures at the PV plant level to reduce security risks, or use Huawei management system to mitigate the risks.

Procedure

Step 1 Choose **Settings > Comm. Param. > FTP**, set FTP parameters, and click **Submit**.

Parameter	Description
FTP server	Set this parameter to the domain name or IP address of the FTP server.
User name	Set this parameter to the user name for logging in to the FTP server.
Password	Set this parameter to the password for logging in to the FTP server.
Remote directory	After you set this parameter, a subdirectory of the same name is created in the default data upload directory (specified by the FTP server).

Parameter	Description
Data export	Specifies whether data can be reported.
File format	<p>Format 1, Format 2, Format 3, and Format 4 are supported.</p> <p>NOTE Format 2 has two more information points than Format 1: E-Day (current-day energy yield) and E-Total (total energy yield). Format 3 has more information points than Format 1 and Format 2: power meter, PID module, user-defined device, and SmartLogger data. Format 4 has more information points than Format 3: active and reactive power of power meters.</p>
File name	Set this parameter to the format of the file name.
Time format	Set this parameter to the time format.
Export mode	<p>The value can be Cyclic or Fixed time.</p> <ul style="list-style-type: none"> • Cyclic: Periodically reports data. Export interval specifies the period for reporting data. File mode specifies whether all data or only the incremental data of a day is reported each time. • Fixed time: Reports data at a specified time. Fixed time specifies the time for reporting data.

 **NOTE**

You can click **Start report test** to check whether the SmartLogger can report data to the FTP server.

----End

Troubleshooting

NOTICE

If the error code is not listed in the following table, provide SmartLogger run logs and contact Huawei technical support.

Error Code	Troubleshooting Suggestion	Error Code	Troubleshooting Suggestion
0x1002	Configure the FTP server address.	0x1003	<ol style="list-style-type: none"> 1. Check whether the DNS server address is correctly configured. 2. Check whether the domain name of the third-party FTP server is correctly configured.

Error Code	Troubleshooting Suggestion	Error Code	Troubleshooting Suggestion
0x1004	Configure the user name of the FTP account.	0x1005	Configure the user name of the FTP account.
0x3001	<ol style="list-style-type: none"> 1. Check whether the FTP server address is correctly configured. 2. Check whether the third-party FTP server is working properly. 	0x3002	<ol style="list-style-type: none"> 1. Check whether the user name of the FTP account is correctly configured. 2. Check whether the password of the FTP account is correctly configured.
0x3007	Check whether the third-party FTP server allows the client to upload data.	0x3008	Ensure that the SmartLogger data upload directory exists on the third-party FTP server.
Other Codes	Provide SmartLogger run logs and contact Huawei technical support.	N/A	N/A

8.3 How Do I Set Email Parameters?

Context

- The SmartLogger can send emails to inform users of the current energy yield information, alarm information, and device status about the PV plant system, helping users know the running conditions of the PV plant system in time.
- When using this function, ensure that the SmartLogger can connect to the configured email server and the Ethernet parameters and email parameters are correctly set for the SmartLogger.

Procedure

- Step 1** Choose **Settings > Comm. Param. > Email**, set Email parameters, and click **Submit**.

Parameter	Description
SMTP server	Set this parameter to the domain name or IP address of the SMTP server.
Encryption mode	Set this parameter to the email encryption mode.
SMTP port	Set this parameter to the email sending port.
User name	Set this parameter to the user name for logging in to the SMTP server.
Password	Set this parameter to the password for logging in to the SMTP server.
Email language	Set this parameter to the language for sending emails.

Parameter	Description
Send address	Set this parameter to the email address for sending emails.
Receive address N NOTE N is 1, 2, 3, 4, or 5.	Set this parameter to the email address for receiving emails.
Yield	Specifies whether to send energy yield data by email and the time for sending emails.
Alarms	Specifies whether to send alarms by email and the severity of the alarms to be sent.

 **NOTE**

You can click **Send test mail** to check whether the SmartLogger can successfully send emails to users.

----End

Troubleshooting

NOTICE

If the error code is not listed in the following table, provide SmartLogger run logs and contact Huawei technical support.

Error Code	Troubleshooting Suggestion	Error Code	Troubleshooting Suggestion
0x2002	<ol style="list-style-type: none">1. Check whether the DNS server address is correctly configured.2. Check whether the domain name and the IP address of the SMTP server are correct.3. Check whether the network communication between the management system and the DNS server is normal.	0x2003	<ol style="list-style-type: none">1. Try again later.2. Check whether the domain name and the IP address of the SMTP server are correct.

Error Code	Troubleshooting Suggestion	Error Code	Troubleshooting Suggestion
0x200b	<ol style="list-style-type: none">1. Check whether the DNS server address is correct.2. Check whether the domain name and the IP address of the SMTP server are correct.	0x4016	<ol style="list-style-type: none">1. Try again later.2. Check whether the DNS server address is correctly configured.3. Check whether the domain name and the IP address of the SMTP server are correct.
0x406e	Confirm the encryption mode and port supported by the email box, and check whether they are correct.	0x8217	<ol style="list-style-type: none">1. Check whether the user name and password are correct.2. Log in to the email box of the email sender and start the SMTP service.3. Log in to the email box of the email sender and start the third-party client license code function.
0xa003	Check whether the domain name and the IP address of the SMTP server are correct.	0xa005	Enter the user name correctly.
0xa006	Enter the password correctly.	0xe002	Configure the domain/IP of the SMTP server correctly.
0xe003	Configure the addresses for sending and receiving emails correctly.	Others	Please provide SmartLogger running logs and contact Huawei Service Center.

8.4 How Do I Change the SSID and Password of the Built-in WLAN?

Procedure

- Step 1** Choose **Settings** > **Wireless Network**, set parameters for the built-in WLAN, and click **Submit**.

Parameter	Description
WLAN	<p>Specifies the status of the built-in WLAN.</p> <ul style="list-style-type: none">• Always ON: The WLAN module is powered on.• OFF in idle state: The WLAN module is automatically powered off when idle. You can hold down the RST button for 1s to 3s to power on the WLAN module and wait for connecting to the SUN2000 app. If the SUN2000 app is not connected, the WLAN module is automatically powered off after it is powered on for 4 hours.• Always OFF: The WLAN module is not powered on and cannot be powered on by holding down the button.
SSID	<ul style="list-style-type: none">• Specifies the name of the built-in WLAN.• The default name of the built-in WLAN is Logger_SN.
Password	<ul style="list-style-type: none">• Specifies the password for accessing the built-in WLAN.• The initial password of the built-in WLAN is Changeme.• Use the initial password upon first power-on and change it immediately after login. To ensure account security, change the password periodically and keep the new password in mind. Not changing the initial password may cause password disclosure. A password left unchanged for a long period of time may be stolen or cracked. If a password is lost, the device needs to be restored to factory settings. In these cases, the user is liable for any loss caused to the PV plant.

----End

8.5 How Do I Use DI Ports?

- The SmartLogger provides four DI ports, which support DI active scheduling, DI reactive scheduling, DRM, remote shutdown, and input of correlated alarms.
- For details about DI active scheduling, DI reactive scheduling, DRM and remote shutdown, see [6.7 Power Grid Scheduling](#).

NOTICE

Before setting the corresponding function, ensure that the DI port is not set for other purposes. Otherwise, the setting will fail.

Alarm Input

When a valid level is delivered into a DI port, an alarm is raised. You can set the alarm name and severity.

Step 1 Choose **Settings > DI** and associate alarms with DI ports.

Parameter	Description
Activation status	If this parameter is set to Activated for a DI port, you can set the function of the DI port. Otherwise, you cannot set the function of the DI port.
Dry contact status	Specifies the valid input status of a DI port.
Alarm generation	Specifies whether to allow alarm generation.
Alarm severity	Specifies the alarm severity.
Trigger shutdown	Specifies whether to deliver a solar inverter remote shutdown command.
Trigger startup	Specifies whether to deliver a solar inverter remote startup command.
Alarm name	Specifies the alarm name.
Startup delay	Specifies the delay time for the automatic startup of the solar inverter after Trigger startup is set to Enable .

----End

8.6 How Do I Use DO Ports?

The SmartLogger provides two DO ports, which support the reset of external routers, audible and visual alarming for grounding faults, and output of correlated alarms.

NOTICE

Before setting the corresponding function, ensure that the DO port is not set for other purposes. Otherwise, the setting will fail.

Resetting an External Router

Connect one DC power cable of the 3G router to a DO port on the SmartLogger, and power on or off the wireless module by connecting or disconnecting the DO dry contact to control the reset of the 3G router.

Step 1 Cut off a DC power cable of the router, and connect the DC power cable to a DO port on the SmartLogger.

Figure 8-3 Connecting to a DO port

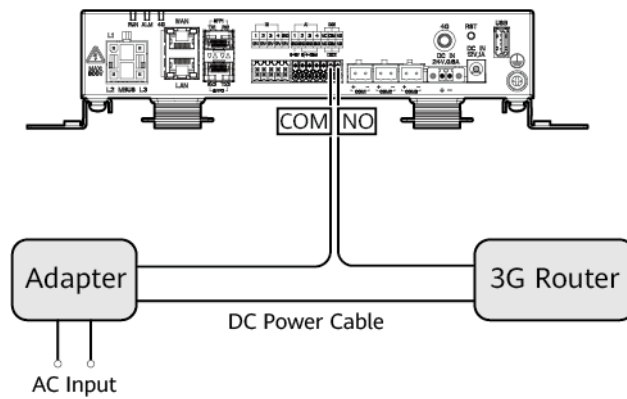

IL04100001

Step 2 Choose **Settings > Other parameters** and set **Reset the external router** to the DO port.

----End

Audible and Visual Alarm for Grounding Fault

Connect one DC power cable of the audible and visual alarm to a DO port on the SmartLogger, and power on or off the audible and visual alarm by connecting or disconnecting the DO dry contact to implement audible and visual alarming for grounding faults.

Step 1 Connect one DC power cable of the audible and visual alarm to the DO port (COM/NO) on the SmartLogger.

Step 2 Choose **Settings > Alarm Output** and associate **Low Insulation Resistance** with the DO port.

----End

Alarm Output

After a solar inverter alarm is associated with a DO port, the alarm signal is delivered from the DO port when the solar inverter raises the alarm.

Step 1 Choose **Settings > Alarm Output** and associate solar inverter alarms with the DO port.

NOTE

If the SmartLogger is restarted or powered off after the function is enabled, the DO port status may change and the alarm output may be abnormal.

----End

8.7 How Do I Use the USB Port?

The SmartLogger has a USB port, which provides 5 V/1 A power supply.

- The USB port can connect to a 3G router to supply power to the router, and the power supply of the USB port is disconnected when communication is disconnected, implementing 3G router reset control.

NOTICE

If the maximum operating current of the 3G router is greater than 1 A, it cannot be connected through the USB port.

- The USB port can connect to a USB flash drive for local maintenance, device log export, and device upgrade.

NOTE

It is recommended that you use a SanDisk, Netac, or Kingston USB flash drive to ensure compatibility.

Connecting to a 3G Router

If the DC power cable of the 3G router has a standard USB connector with the maximum operating current of less than 1 A, it can be directly connected to the USB port on the SmartLogger.

- Step 1** Connect the USB connector of the DC power cable for the 3G router to the USB port on the SmartLogger.
- Step 2** If you need to use the reset function of the external router, choose **Settings > Other Parameters** and set **Reset the external router** to **USB**.

----End

Connecting to a USB Flash Drive for Local Maintenance

- Step 1** Insert the USB flash drive into the USB port at the bottom of the SmartLogger.
- Step 2** Log in to the app as **installer**, choose **More > System Maintenance** on the SmartLogger screen, and perform the local maintenance.

Local Maintenance	Description	Prerequisites
Offline Configuration	After the power station deployment configuration file is imported through Offline Configuration, the SmartLogger automatically completes the deployment configuration.	The power station deployment configuration file has been saved in the root directory of the USB flash drive.

Local Maintenance	Description	Prerequisites
Exporting All Files	Before replacing the SmartLogger, export the SmartLogger configuration file to a local PC.	N/A
Importing All Files	After replacing the SmartLogger, import the local configuration file to the new SmartLogger. After the import is successful, the SmartLogger restarts for the configuration file to take effect. Ensure that the parameters on the Settings tab page and the parameters for the built-in MBUS are correctly set.	All exported files have been saved in the root directory of the USB flash drive.

Step 3 After the local maintenance is complete, remove the USB flash drive.

NOTICE

After files are imported, the SmartLogger automatically restarts.

----End

Connecting to a USB Flash Drive to Export Device Logs

Step 1 Connect the USB flash drive to the USB port on the SmartLogger.

Step 2 Log in to the app as **installer**, choose **More > Device Logs**, select the device whose logs you want to export, and tap **Next**.

Step 3 Select the types of logs to be exported and tap **Confirm** to start exporting device logs.

Step 4 After the logs are exported, remove the USB flash drive.

----End

Connecting to a USB Flash Drive for Device Upgrade

You can upgrade the SmartLogger, solar inverter, MBUS module, or PID module using a USB flash drive.

Step 1 Save the device upgrade package to the USB flash drive.

 **NOTE**

Do not decompress the upgrade package.

- Step 2** Connect the USB flash drive to the USB port on the SmartLogger.
- Step 3** Log in to the app as **installer**, choose **More > Upgrade**, select a single device or multiple devices of the same type, and tap **Next**.
- Step 4** Select the upgrade package and tap **Next**.
- Step 5** Confirm the upgrade package and the device to be upgraded, and tap **Finish** to start upgrading the device.

 **NOTE**

After the upgrade is complete, the device automatically restarts.

- Step 6** After the upgrade is complete, remove the USB flash drive.
- End

8.8 How Do I Change a Device Name?

Procedure

- Step 1** Choose **Maintenance > Device Mgmt > Device List**.
- Step 2** Modify the device name based on the actual situation, select the modified entry, and click **Modify Device Info**.

 **NOTE**

You can also export device information to a .csv file, modify the file, and import the modified file to modify device information.

----End

8.9 How Do I Change the Communications Address?

The SmartLogger allows you to change the communications addresses of Huawei devices on the **Connect Device** or **Device List** page.

Changing the Communications Address on the Connect Device Page

- Step 1** Choose **Maintenance > Device Mgmt. > Connect Device**.
- Step 2** Click **Auto Assign Address**, set the start address for assignment, and confirm the address assignment.
- Step 3** Confirm the address adjustment, adjust the device address as required, and click **Address Adjustment**.
- Step 4** Confirm to search for the device again.
- Step 5** After the search is complete, click **Close**.

----End

Changing the Communications Address on the Device List Page

- Step 1** Choose **Maintenance > Device Mgmt. > Device List**.
 - Step 2** Change the device communications address and device name based on the site requirements, select the modified entries, and click **Modify Device Info**.
 - Step 3** Choose **Maintenance > Device Mgmt. > Connect Device** and click **Auto. Search**.
 - Step 4** After the search is complete, click **Close**.
- End

8.10 How Do I Export Inverter Parameters?

Context

You can export configuration parameters of multiple solar inverters to a .csv file. Site engineers can then check whether the solar inverter configurations are correct in the exported file.

Procedure

- Step 1** Choose **Maintenance > Device Mgmt > Export Param**.
 - Step 2** Select the name of the device whose parameters are to be exported, and click **Export**.
 - Step 3** Observe the progress bar and wait until the export is complete.
 - Step 4** After the export is successful, click **Log archiving** to save the file.
- End

8.11 How Do I Clear Alarms?

Context

You can clear all active and historical alarms for the selected device and re-collect alarm data.

Procedure

- Step 1** Choose **Maintenance > Device Mgmt. > Clear Alarm**.
- Step 2** Select the name of the device whose alarms are to be cleared, click **Submit**, and choose **All, Locally synchronized alarms, or Alarms stored on devices** to clear alarms.

 NOTE

If alarms are cleared for the SmartLogger, you must reset alarms on the management system. Otherwise, the management system cannot obtain the alarm information collected by the SmartLogger after the alarms are cleared.

----End

8.12 How Do I Enable the AI1 Port to Detect SPD Alarms?

Context

In the smart array controller application scenario, the AI1 port on the SmartLogger can be connected to the SPD alarm output to raise an alarm when the SPD is faulty.

Procedure

- Step 1** Choose **Settings > Other Parameters** and set **AI1 SPD detection alarm** to **Enable**.

----End

8.13 Which Models of Power Meters and EMIs Are Supported by the SmartLogger?

Table 8-1 Supported power meters

Vendor	Model	Export Limitation
ABB	A44	-
Acrel	PZ96L	Supported
Algodue	UPM209	Supported NOTE When the power meter connects to the SmartLogger, an external 120-ohm resistor needs to be connected to the RS485 bus of the power meter. For details, see the user manual of the power meter.
-	BackUp-CT	Supported
CHNT	DTSU666	-
-	DTSU666-H	Supported
-	DTSU666-HW	Supported
Elster	A1800ALPHA	-

Vendor	Model	Export Limitation
GAVAZZI	EM210	-
Janitza	UMG103-CBM	Supported
Janitza	UMG604	Supported
Lead	LD-C83	-
MingHua	CRDM-830	-
Mitsubishi	EMU4-BD1-MB	Supported NOTE <ul style="list-style-type: none"> • Not applicable to single-phase power scenarios. • When the power meter connects to the SmartLogger, an external 120-ohm resistor needs to be connected to the RS485 bus of the power meter. For details, see the user manual of the power meter.
Mitsubishi	ME110NSR-MB	-
Mitsubishi	ME110SR-MB	-
Mitsubishi	ME110SSR-MB	-
Mitsubishi	M8FM-N3LTR	-
Mitsubishi	ME110SSR-4APH	-
NARUN	PD510	-
NetBiter	CEWE	-
People	RM858E	-
Schneider	PM2xxx	-
Schneider	PM5100	-
Schneider	PM5300	-
SFERE	PD194Z	-
Socomec	COUNTIS E43	Supported NOTE <ul style="list-style-type: none"> • Not applicable to single-phase power scenarios. • When the power meter connects to the SmartLogger, an external 120-ohm resistor needs to be connected to the RS485 bus of the power meter. For details, see the user manual of the power meter.
Toshiba	S2MS	-

Vendor	Model	Export Limitation
Wave Energy	PWM-72	-
WEG	MMW03-M22CH	Supported
YDS	YDS60-80	Supported NOTE Applicable only to three-phase power scenarios.
	YDS70-C16	Supported NOTE Applicable only to single-phase power scenarios.
	YDS60-C24	Supported NOTE Applicable only to three-phase power scenarios.

Table 8-2 Supported EMIs

Vendor	Model	EMI Information
ABB	VSN800-12	Total irradiance, ambient temperature, and PV module temperature
	VSN800-14	Total irradiance, ambient temperature, PV module temperature, wind direction, and wind speed
Gill MetPak Pro	Gill MetPak Pro	Total irradiance, ambient temperature, PV module temperature, wind direction, and wind speed
Hukseflux SRx	Hukseflux SRx	Total irradiance and ambient temperature
Ingenieurbüro Si-RS485TC	Ingenieurbüro Si-RS485TC	Total irradiance, ambient temperature, PV module temperature, and wind speed
Kipp&Zonen	SMPx series	Total irradiance and ambient temperature

Vendor	Model	EMI Information
Lufft	WSx-UMB	Total irradiance, ambient temperature, wind direction, and wind speed
	WSx-UMB(external sensors)	Total irradiance, ambient temperature, PV module temperature, wind direction, and wind speed
Meier-NT ADL-SR	Meier-NT ADL-SR	Total irradiance, ambient temperature, PV module temperature, and wind speed
MeteoControl	SR20-D2	Total irradiance and ambient temperature
RainWise	PVmet-150	Total irradiance, ambient temperature, and PV module temperature
	PVmet-200	Total irradiance, ambient temperature, PV module temperature, wind direction, and wind speed
Soluzione Solare	SunMeter	Total irradiance and ambient temperature
Jinzhou Licheng	Jinzhou Licheng	Total irradiance, ambient temperature, PV module temperature, wind direction, and wind speed
Jinzhou Solargiga	PC-4	Total irradiance, ambient temperature, PV module temperature, wind direction, and wind speed
Handan	RYQ-3	Total irradiance, ambient temperature, PV module temperature, wind direction, and wind speed

Vendor	Model	EMI Information
Sensor ADAM NOTE The sensor-type EMI (current-type or voltage-type) communicates with the SmartLogger through the ADAM analog-to-digital converter.	-	-

8.14 How Do I Check the SIM Card Status?

Choose **Over View** > **Mobile Data** to view the SIM card status.

Table 8-3 SIM card status

Parameter	Status	Description
4G module status	Card absent	No SIM card is detected. Insert a SIM card.
	Failed to register the card.	<ol style="list-style-type: none"> 1. Check whether the SIM card account is in arrears. If yes, top up the account. 2. Check whether the network quality is poor. If yes, use a SIM card of another carrier with good signal quality. 3. Check whether the SIM card has been bound to another device. If yes, unbind the SIM card from the device or replace the SIM card.
	<ul style="list-style-type: none"> • Not connected • The card is in position. 	The SmartLogger is trying to set up a dial-up connection. Wait for the connection to be set up.
	Connected	The dial-up connection is set up successfully.
	Enter the PIN.	The SIM card has been set to require a personal identification number (PIN). Contact the carrier of the SIM card for the PIN, choose Settings > Wireless Network , and enter the correct PIN.
	Enter the PUK.	If the number of incorrect PIN attempts exceeds the upper limit, you need to enter the PIN unblocking key (PUK). Contact the carrier of the SIM card for the PUK. Choose Settings > Wireless Network and enter the correct PUK.

Parameter	Status	Description
Traffic status	Normal	The used traffic does not exceed the monthly traffic package, and the remaining traffic is sufficient.
	Warning	The used traffic exceeds 80% of the monthly traffic package, and the remaining traffic is insufficient.
	Used up	The used traffic exceeds the monthly traffic package. Traffic is used up. Top up the SIM card account immediately.
	No package configured	Choose Settings > Wireless Network and configure a monthly traffic package.

8.15 How Do I Use Mobile Network Sharing?

Remotely Accessing the WebUI over a Mobile Network

 NOTE

A 4G SmartLogger supports remote access to the SmartLogger WebUI over the built-in 4G wireless communication.

- Step 1** Insert a SIM card with a fixed IP address into the SIM card slot of the SmartLogger. Choose **Over View > Mobile Data** to check the SIM card status and ensure that the 4G wireless communication is normal.
- Step 2** Choose **Settings > Other Parameters** and set **Mobile network sharing** to **Enable**.

NOTICE

After this function is enabled, the SmartLogger is directly exposed to the public network and is vulnerable to network attacks.

Figure 8-4 Other parameters

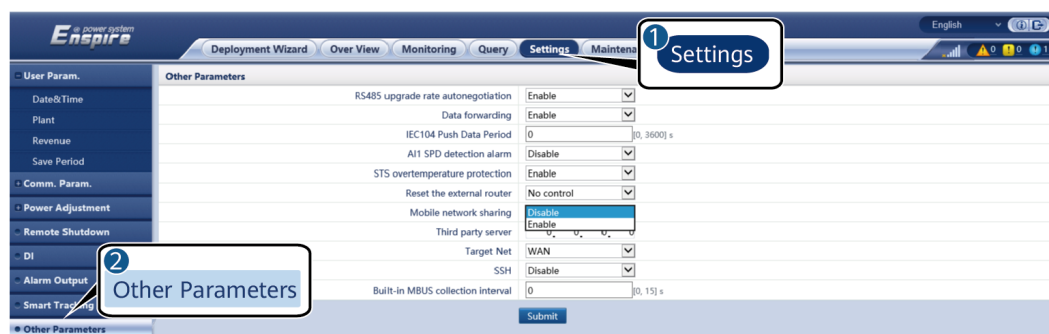

Step 3 Open a web browser, enter **https://XX.XX.XX.XX** (XX.XX.XX.XX is the fixed IP address of the SIM card) in the address box, and press **Enter**. The login page is displayed.

----End

Sharing a Mobile Network with Other Devices

NOTE

A 4G SmartLogger supports the sharing of the built-in 4G network with other devices for Internet access.

Step 1 Connect the network cable of another device to the WAN port of the SmartLogger.

Step 2 Choose **Settings > Other Parameters** and set **Mobile network sharing** to **Enable**.

NOTICE

After this function is enabled, the SmartLogger is directly exposed to the public network and is vulnerable to network attacks.

Figure 8-5 Other parameters



Step 3 Choose **Settings > Comm. Param. > Wired Network**, set network parameters for third-party devices.

1. IP address of the third-party device: This parameter must be in the same network segment as that of the SmartLogger and must be different from that of other devices.
2. Subnet mask of the third-party device: Set this parameter to the subnet mask of the SmartLogger.
3. Third-party device gateway: Set this parameter to the IP address of the SmartLogger.
4. (Optional) Third-party DNS server: If the third-party device needs to connect to the server address in domain name format, you need to set the DNS server address, which can be set to a public DNS server address, for example, 8.8.8.8. (The DNS server address of the wired network of the SmartLogger with mobile network sharing enabled cannot be the same as that of the third-party device. You are advised to set the DNS server address to 0.0.0.0 or 10.129.0.84.)

 NOTE

To query the network parameters of the SmartLogger, choose **Settings > Comm. Param. > Wired Network**.

----End

8.16 WebUI Allows Login Only in Chinese and Prompts to Switch to Chinese

If the WebUI uses a language other than Chinese and the SmartLogger detects that an inverter sold only in Chinese Mainland is connected, a message is displayed indicating that the WebUI allows login only in Chinese and the language will be switched to Chinese after login.

Figure 8-6 WebUI allows login only in Chinese

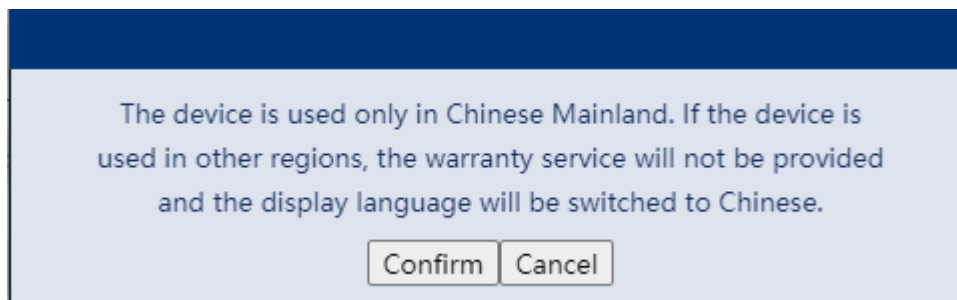
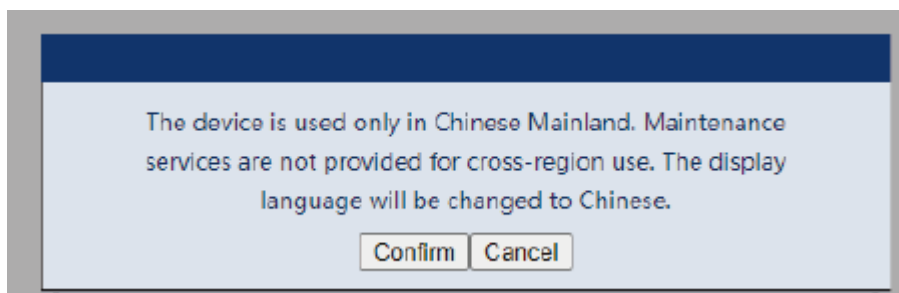

Figure 8-7 WebUI prompts to switch to Chinese



8.17 How Do I Identify the Meter Wiring Direction on the SmartLogger?

- Correct wiring: When the plant feeds electricity to the grid, the active power of the meter is a negative value. When the plant draws electricity from the grid, the active power of the meter is a positive value.
- Reverse wiring: When the plant feeds electricity to the grid, the active power of the meter is a positive value. When the plant draws electricity from the grid, the active power of the meter is a negative value. Negative wiring may occur.

8.18 Resetting Password

Role	Description
Administrator	If you hold down the RST button for 10s to 20s, the SmartLogger enters the safe mode. In this case, the device configuration parameters are retained, but personal privacy and sensitive data, including the login password and email address, are cleared.
Non-administrator	The password of a non-administrator account must be reset using the administrator account. The administrator resets the password and enters the initial password. The user logs in to the system using the initial password provided by the administrator. After the login, the user is forced to change the password.

9 Technical Specifications

9.1 Technical Specifications of the SmartLogger

Device Management

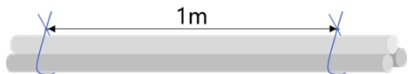
Parameter	Specifications
Number of solar inverters	<ul style="list-style-type: none">SmartLogger3000A: can connect to a maximum of 80 solar inverters.SmartLogger3000B: can connect to a maximum of 150 solar inverters.
Communications mode	RS485, ETH, MBUS (optional), 4G (optional), and SFP (optional)
Maximum communication distance	<ul style="list-style-type: none">RS485: 1000 mETH: 100 mMBUS (multi-core cable): 1000 m; MBUS (single-core cable): 400 m (The three-phase cables must be bound at 1 m intervals)  <ul style="list-style-type: none">Optical fiber (single-mode, 1310 nm optical module): 10,000 m (with the 1000M optical module); 12,000 m (with the 100M optical module)

Common Specifications

Parameter	Specifications
Power adapter	<ul style="list-style-type: none">AC input: 100–240 V, 50/60 HzDC output: 12 V, 2 A
DC power supply	24 V, 0.8 A
Power consumption	<ul style="list-style-type: none">SmartLogger3000A: 8 W (typical)SmartLogger3000B: 9 W (typical)SmartLogger3000B + SmartModule1000A: 10 W (typical)15 W (maximum)
Dimensions (W x H x D)	<ul style="list-style-type: none">259 mm x 160 mm x 59 mm (including mounting ears)225 mm x 160 mm x 44 mm (excluding mounting ears)
Net weight	2 kg
Operating temperature	–40°C to +60°C
Storage temperature	–40°C to +70°C
Relative humidity	5%–95% RH
IP rating	IP20
Installation mode	Installed on a wall or guide rail
Highest operating altitude	4000 m
Pollution degree	2
Corrosion level	Class B

Ports

Parameter	Specifications
Ethernet electrical port (WAN and LAN)	2 PCS; 10M/100M/1000M auto-sensing
Ethernet optical port (SFP)	2 PCS; supports 100 M/1000 M SFP/eSFP optical modules
MBUS port	1 PCS; supports a maximum AC input voltage of 800 V
RS485 (COM) port	3 PCS; supported baud rates: 1200 bit/s, 2400 bit/s, 4800 bit/s, 9600 bit/s, 19,200 bit/s, and 115,200 bit/s

Parameter	Specifications
USB port	USB2.0
Power output port	1 PCS; DC output: 12 V, 0.1 A
Digital input (DI) port	4 PCS; Passive dry contact signal access
Digital output (DO) port	2 PCS; relay dry contact output ports, supporting NO or NC contacts; supports 12 V, 0.5 A signal voltage
Analog input (AI) port	4 PCS; AI1: supports 0–10 V voltage (passive); AI2–AI4: support 4–20 mA or 0–20 mA input current (passive)
4G antenna port (4G)	1 PCS; SMA-K (external screw inner hole) port, used with the antenna with the SMA-J (internal screw inner pin) port

Wireless Communication

Parameter	Specifications
4G/3G/2G	<p>The SmartLogger3000A01CN supports 2G, 3G, and 4G networks of China Mobile and China Unicom as well as 4G networks of China Telecom.</p> <p>The following frequency bands are supported:</p> <ul style="list-style-type: none">• LTE FDD: B1, B3, B8• LTE TDD: B38, B39, B40, B41• WCDMA: B1, B5, B8, B9• TD-SCDMA: B34, B39• GSM: 900 MHz/1800 MHz
	<p>The SmartLogger3000A01EU and SmartLogger3000A03EU support the following frequency bands:</p> <ul style="list-style-type: none">• LTE FDD: B1, B3, B5, B7, B8, B20• LTE TDD: B38, B40, B41• WCDMA: B1, B5, B8• GSM: 900 MHz/1800 MHz

Parameter	Specifications
	<p>SmartLogger3000A01NH: Supports 3G/4G of Docomo and SoftBank.</p> <p>The following frequency bands are supported:</p> <ul style="list-style-type: none"> • LTE FDD: B1, B3, B8, B18, B19, B26 (only Tokyo, Nagoya, and Osaka support B3) • LTE TDD: B41 • WCDMA: B1, B6, B8, B19
	<p>The SmartLogger3000A01KR supports networks of SK Telecom.</p> <p>The following frequency bands are supported:</p> <ul style="list-style-type: none"> • LTE FDD: B1, B3, B5, B7 • WCDMA: B1
	<p>The SmartLogger3000A01AU supports the following frequency bands:</p> <ul style="list-style-type: none"> • LTE FDD: B1, B2, B3, B4, B5, B7, B8, B28 • LTE TDD: B40 • WCDMA: B1, B2, B5, B8 • GSM: 850 MHz/900 MHz/1800 MHz/1900 MHz
WLAN (local maintenance using app)	2.4G

RF Bands of the 4G Module (SmartLogger3000A01EU and SmartLogger3000A03EU)

Frequency Band	Tx	Rx
WCDMA Band 1	1920–1980 MHz	2110–2170 MHz
WCDMA Band 5	824–849 MHz	869–894 MHz
WCDMA Band 8	880–915 MHz	925–960 MHz
GSM 900	880–915 MHz	925–960 MHz
GSM 1800	1710–1785 MHz	1805–1880 MHz
LTE Band 1	1920–1980 MHz	2110–2170 MHz
LTE Band 3	1710–1785 MHz	1805–1880 MHz
LTE Band 5	824–849 MHz	869–894 MHz

Frequency Band	Tx	Rx
LTE Band 7	2500–2570 MHz	2620–2690 MHz
LTE Band 8	880–915 MHz	925–960 MHz
LTE Band 20	832–862 MHz	791–821 MHz
LTE Band 38	2570–2620 MHz	
LTE Band 40	2300–2400 MHz	
LTE Band 41	2555–2655 MHz	

Output Power of the 4G Module (SmartLogger3000A01EU and SmartLogger3000A03EU)

Frequency Band		Standard Value (Unit: dBm)	Remarks (Unit: dB)
GSM 900	GMSK (1Tx Slot)	33	±2
	8PSK (1Tx Slot)	27	±3
GSM 1800	GMSK (1Tx Slot)	30	±2
	8PSK (1Tx Slot)	26	±3
WCDMA Band 1		24	+1/-3
WCDMA Band 5		24	+1/-3
WCDMA Band 8		24	+1/-3
LTE Band 1		23	±2
LTE Band 3		23	±2
LTE Band 5		23	±2
LTE Band 7		23	±2
LTE Band 8		23	±2
LTE Band 20		23	±2
LTE Band 38		23	±2
LTE Band 40		23	±2
LTE Band 41		23	±2

WLAN

Parameter	Specifications
Frequency band	2.4 GHz: 2.4–2.4835 GHz
Gain	2.4 GHz: 2.85 dBi
Transmit power	2.4 GHz: 1 x 100 mW
Maximum throughput	2.4 GHz: 65 Mbit/s
Single/Dual band mode	Single
MIMO	2.4 GHz frequency band: 1T1R
Maximum number of online users	6
Polarization mode	Linear
Directivity	Multi-dimensional

9.2 Technical Specifications of the SmartModule

Device Management

Parameter	Specifications
Communications mode	RS485, ETH
Maximum communication distance	<ul style="list-style-type: none">• RS485:1000 m• ETH: 100 m

Common Specifications

Parameter	Specifications
DC power supply	<ul style="list-style-type: none">• DC 12 V: DC 2.0 power socket male connector• DC 24 V: cord end terminal
Power consumption	Typical: 4 W; maximum: 5 W
Dimensions (H x W x D)	<ul style="list-style-type: none">• Including mounting ears: 160 mm x 179 mm x 59 mm• Without mounting ears: 160 mm x 125 mm x 44 mm
Net weight	1 kg
Operating temperature	-40°C to +60°C

Parameter	Specifications
Storage temperature	-40°C to +70°C
Humidity	5%–95% RH
Ingress protection rating	IP20
Installation mode	Installed on a wall or guide rail
Maximum operating altitude	4000 m
Pollution level	Level 2
Corrosion level	Class B

Ports

Parameter	Specifications
Ethernet electrical port (GE)	4 PCS; 10M/100M/1000M auto-sensing
RS485 port (COM)	3 PCS; supported baud rates: 1200 bit/s, 2400 bit/s, 4800 bit/s, 9600 bit/s, 19,200 bit/s, and 115,200 bit/s
Power output port	1 PCS; DC output: 12 V, 0.1 A
Digital input (DI) port	4 PCS; Passive dry contact signal access
PT port (PT)	Two PCS; supports the access of signals from a 3-wire or 2-wire PT100/PT1000 temperature sensor
Analog input (AI) port	4 PCS; AI1: supports 0–10 V voltage (passive); AI2–AI4: support 4–20 mA or 0–20 mA input current (passive)

A Product User Lists

Table A-1 User list

Login Mode	SmartLogger Version	User Name	Initial Password
App	Factory version earlier than V300R023C00	Installer	00000a
		User	00000a
	Updated to V300R023C00 or later	installer	00000a
		user	
	Factory version V300R023C00 or later	installer	None. You need to set a password upon the initial login.
		user	
WebUI	Factory version earlier than V300R023C00	admin	Changeme
	Updated to V300R023C00 or later	installer	None. You need to set a password upon the initial login.
		admin	Changeme
	Factory version V300R023C00 or later	installer	None. You need to set a password upon the initial login.

Table A-2 Second challenge authentication

Authentication Mode	User Name	Initial Password
SmartLogger authentication by the management system	emscomm	/EzFp+2%r6@IxSCv
SmartModule authentication by the SmartLogger	SmoduleAdmin	/EzFp+2%r6@IxSCv

Table A-3 Operating system user list

User Name	Initial Password
enspire	Changeme
root	Changeme
prorunacc	No initial password
bin	No initial password
daemon	No initial password
nobody	No initial password
sshd	No initial password

B Domain Name List of Management Systems

 **NOTE**

The list is subject to change.

Table B-1 Domain names of management systems

Domain Name	Data Type	Scenario
intl.fusionsolar.huawei.com	Public IP address	FusionSolar SmartPVMS NOTE The domain name is compatible with cn.fusionsolar.huawei.com (Chinese mainland).
neteco.alsoenergy.com	Public IP address	Partner management system
re-ene.kyuden.co.jp	Public IP address	Remote output control server of Kyushu Electric Power Company
re-ene.yonden.co.jp	Public IP address	Remote output control server of Shikoku Electric Power Company

C Port No. List

Table C-1 Port No.

Type of Connected Access Management	Management System Setting Port No.	Open Port No. of Router (Firewall)	Remarks
NetEco	16100	16100, 2121, 11000-11500	<ul style="list-style-type: none">• 16100: used to query and set data between the SmartLogger and the management system.• 2121 and 11000-11500: used to upload and download data or files between the SmartLogger and the management system using FTPS.
FusionSolar SmartPVMS	16100	16100, 2121, 2122, 10000-12000	<p>The device performance data is updated in real time. Each device requires 3 MB traffic per day.</p> <ul style="list-style-type: none">• 16100: used to query and set data between the SmartLogger and the management system.• 2121, 2122 and 10000-12000: used to upload and download data or files between the SmartLogger and the management system using FTPS.

Type of Connected Access Management	Management System Setting Port No.	Open Port No. of Router (Firewall)	Remarks
	27250	27250, 27251, 2122, 10000–12000	<p>Traffic-saving port. This port is recommended when the SmartLogger connects to the management system in wireless mode. The device performance data is updated every 5 minutes.</p> <ul style="list-style-type: none">• 27250 and 27251: used to query and set data between the SmartLogger and the management system.• 2122 and 10000–12000: used to upload and download data or files between the SmartLogger and the management system using FTPS.

 **NOTE**

- If a third-party management system connects to the SmartLogger over Modbus TCP, the SmartLogger port No. is 502, which is used to query and set data between the SmartLogger and the third-party management system.
- If a third-party management system connects to the SmartLogger over IEC104, the SmartLogger port No. is 2404, which is used to query and set data between the SmartLogger and the third-party management system.
- If the SmartLogger connects to a third-party FTP server over FTP, the common port No. is 21, which is used to periodically upload performance data to the third-party FTP server.
- If the SmartLogger connects to a third-party email server over SMTP, the common port No. is 25, 465, or 587, which is used to send emails to the email server.
- If the SmartLogger connects to a third-party NTP server over NTP, the common port No. is 123, which is used for time synchronization with the NTP server.
- If the SmartLogger connects to a remote output server of Japan Electric Power Company over HTTPS, the common port No. is 443, which is used to synchronize the scheduling table with the electric power company.

D Certificate Management and Maintenance

D.1 Preconfigured Certificate Risk Disclaimer

The Huawei-issued certificates preconfigured on Huawei devices during manufacturing are mandatory identity credentials for Huawei devices. The disclaimer statements for using the certificates are as follows:

1. Preconfigured Huawei-issued certificates are used only in the deployment phase, for establishing initial security channels between devices and the customer's network. Huawei does not promise or guarantee the security of preconfigured certificates.
2. The customer shall bear consequences of all security risks and incidents arising from using preconfigured Huawei-issued certificates as service certificates.
3. A preconfigured Huawei-issued certificate is valid from the manufacturing date until May 2041.
4. Services using a preconfigured Huawei-issued certificate will be interrupted when the certificate expires.
5. It is recommended that customers deploy a PKI system to issue certificates for devices and software on the live network and manage the lifecycle of the certificates. To ensure security, certificates with short validity periods are recommended.

D.2 Application Scenarios of Preconfigured Certificates

File Path and Name	Application Scenario	Replacement
/mnt/log/smodule_ca.crt	Authenticates the validity of the peer extension module for communication with the TLS extension module.	For details about how to replace a certificate, contact technical support engineers to obtain the corresponding security maintenance manual.
/mnt/log/smodule_server.crt		
/mnt/home/cert/web/server.crt	Authenticates the validity of the peer web module to be connected.	
/mnt/log/ca_1.crt	Authenticates the validity of the peer NMS for communication through Modbus-TCP.	
/mnt/log/client_1.crt		
/mnt/log/ca_2.crt		
/mnt/log/client_2.crt		
/mnt/log/client2_ca.crt		
/mnt/log/client2.crt		
/mnt/log/ca_new.crt		
/mnt/log/client_new.crt		
/mnt/log/tcpmb_server_cert/ca.crt	Authenticates the validity of the peer mobile app for communication through Modbus-TCP.	Certificate replacement is not supported.
/mnt/log/tcpmb_server_cert/tomcat_client.crt		
/mnt/log/cmu_ca.crt	Authenticates the validity of the peer CMU for communication through Modbus-TCP.	For details about how to replace a certificate, contact technical support engineers to obtain the corresponding security maintenance manual.
/mnt/log/cmu_client.crt		
/mnt/log/ca_new.crt	Authenticates the validity of the peer STS, PCS, or inverter for communication through Modbus-TCP.	
/mnt/log/client_new.crt		

E Contact Information

If you have any questions about this product, please contact us.



<https://digitalpower.huawei.com>

Path: **About Us > Contact Us > Service Hotlines**

To ensure faster and better services, we kindly request your assistance in providing the following information:

- Model
- Serial number (SN)
- Software version
- Alarm ID or name
- Brief description of the fault symptom

 **NOTE**

EU Representative Information: Huawei Technologies Hungary Kft.

Add.: HU-1133 Budapest, Váci út 116-118., 1. Building, 6. floor.

Email: hungary.reception@huawei.com

F Digital Power Customer Service



<https://digitalpower.huawei.com/robotchat/>

G Acronyms and Abbreviations

A

AC Alternating Current

AI Analog Input

AO Analog Output

APP Application

B

BMU Battery Monitoring Unit

C

COM Communication

CPE Customer Premises
Equipment

CMU Central Monitoring Unit

D

DC Direct Current

DI Digital Input

DO	Digital Output
E	
EMI	Environmental Monitoring Instrument
ETH	Ethernet
ESU	Energy Storage Unit
ESC	Smart Rack Controller
ESR	Battery Rack
ESM	Battery Pack
G	
GE	Gigabit Ethernet
GND	Ground
H	
HVAC	Heating, Ventilation and Air Conditioning
L	
LAN	Local Area Network
LED	Light-emitting Diode
LTE	Long Term Evolution
M	
MBUS	Monitoring bus

N

NC Normally Closed

NO Normally Open

P

POE Power over Ethernet

PCS Smart PCS

R

RST Reset

RSTP Rapid Spanning Tree
Protocol

S

SFP Small Form-factor
Pluggable

STP Spanning Tree Protocol

SOC State of Charge

SOH State of Health

T

TCU Temperature Control Unit

U

USB Universal Serial Bus

W

WAN	Wide Area Network
WEEE	Waste Electrical and Electronic Equipment